



POWER EQUIPMENT
PRESSURE WASHERS AND GENERATORS





HUSTLER® - THE BRAND YOU CAN RELY ON

Across the globe, the Hustler brand signifies innovation, strength, performance, and superior customer care resulting in unmatched customer loyalty. Our mission is to provide the most dependable, useful, and time-saving products in outdoor maintenance.

POWER EQUIPMENT

OVERVIEW

PRESSURE WASHERS

INVERTER GENERATORS

GENERATORS

HH3324

HH3535

HH3725

HH4035

HH4240

HH4440

HH4400

HIG2200

HIG3632E

HIG4540E

HPGH5500

HPGH8500

HPGH8500E

PRESSURE WASHERS

Hustler Turf pressure washers are strong and durable machines with HONDA® power. With an ultra-lightweight aircraft-grade aluminum frame, they are easy to maneuver and transport. Hustler pressure washers come with a best-in-class warranty providing you peace of mind.



HH3324

- ✓ 3300 PSI @ 2.4 GPM
- ✓ Easy to use
- ✓ Compact design
- ✓ Lightweight and small enough for one person to easily transport
- ✓ Great for cleaning decks, patios, siding, outdoor furniture and prepping home exteriors for painting



SPECIFICATIONS	
ENGINE HONDA® GC190	PUMP OEM TECHNOLOGIES™ CAM PUMP
PSI 3300	GPM 2.4
HOSE MORFLEX™ 1/4" x 25'	NOZZLES 0°, 15°, 25°, 40°, SOAP



Restrictions apply. See your Authorized Hustler Dealer for warranty details.

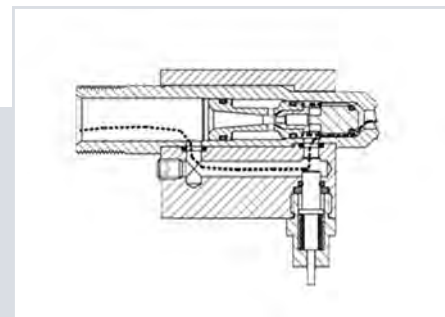

Innovative Pump Design
Equipped with a maintenance-free OEM Technologies™ axial cam pump.



Strength & Flexibility
MorFlex™ hose with a polyurethane jacket is up to three times more abrasive-resistant than rubber while remaining lightweight and kink-resistant.



Ergonomic Side-Assist Spray Gun
Professional-style spray gun with ergonomic 360° rotating handle.

HH3535

- ✓ 3500 PSI @ 2.5 GPM
- ✓ Powerful CRX® engine
- ✓ Commercial axial pump
- ✓ Powder coated steel frame
- ✓ Ensures professional-grade cleaning for your fleet and facility maintenance



SPECIFICATIONS	
ENGINE CRX208	PUMP AAA™ AX300 COMMERCIAL AXIAL CAM PUMP
PSI 3500	GPM 2.5
HOSE MORFLEX™ 5/16" x 25'	NOZZLES 0°, 15°, 25°, 40°, SOAP AND TURBO



Restrictions apply. See your Authorized Hustler Dealer for warranty details.



Innovative Pump Design
Highly efficient, while minimizing engine load and delivering top performance. Equipped with stainless steel pistons for improved seal life, high performance double high pressure seals, and a brass head with an integrated adjustable unloader.



Strength & Flexibility
MorFlex™ hose with a polyurethane jacket is up to three times more abrasive-resistant than rubber while remaining lightweight and kink-resistant.



Ergonomic Side-Assist Spray Gun
Professional-style spray gun with ergonomic 360° rotating handle.

HH3725

- ✓ 3700 PSI @ 2.5 GPM
- ✓ Powerful Honda® engine
- ✓ Reliable triplex pump
- ✓ Ultra-lightweight aircraft-grade aluminum frame
- ✓ Ensures professional-grade cleaning for your fleet and facility maintenance



SPECIFICATIONS	
ENGINE HONDA® GX200	PUMP AAA™ INDUSTRIAL TRIPLEX PUMP
PSI 3700	GPM 2.5
HOSE MONSTER™ STEEL-BRAIDED 3/8" x 50'	NOZZLES 0°, 15°, 25°, 40°, SOAP AND TURBO

COMMERCIAL
10
YEAR
LIMITED
FRAME
WARRANTY

COMMERCIAL
3
YEAR
LIMITED
ENGINE
WARRANTY

COMMERCIAL
5
YEAR
LIMITED
PUMP
WARRANTY

Restrictions apply. See your Authorized Hustler Dealer for warranty details.

HH4035

- ✓ 4000 PSI @ 3.5 GPM
- ✓ Powerful Honda® engine
- ✓ Reliable triplex pump
- ✓ Ultra-lightweight aircraft-grade aluminum frame
- ✓ Provides a pro-clean for oversized jobs



SPECIFICATIONS	
ENGINE HONDA® GX270	PUMP AAA™ INDUSTRIAL TRIPLEX PUMP
PSI 4000	GPM 3.5
HOSE MONSTER™ STEEL-BRAIDED 3/8" x 50'	NOZZLES 0°, 15°, 25°, 40°, SOAP AND TURBO

COMMERCIAL
10
YEAR
LIMITED
FRAME
WARRANTY

COMMERCIAL
3
YEAR
LIMITED
ENGINE
WARRANTY

COMMERCIAL
5
YEAR
LIMITED
PUMP
WARRANTY

Restrictions apply. See your Authorized Hustler Dealer for warranty details.



Innovative Pump Design
External unloader with external bypass for fast and easy maintenance as well as increased pump protection.



Strength & Flexibility
Dual-braided MONSTER Hose™. Polyurethane outer jacket. Non-marring. Three times more abrasion-resistant than rubber hose.



Maximum Cleaning
Turbo nozzle delivers a faster and deeper clean with a powerful oscillating jet.



Innovative Pump Design
External unloader with external bypass for fast and easy maintenance as well as increased pump protection.

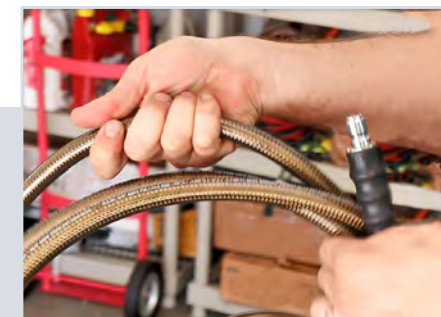

Strength & Flexibility
Dual-braided MONSTER Hose™. Polyurethane outer jacket. Non-marring. Three times more abrasion-resistant than rubber hose.



Maximum Cleaning
Turbo nozzle delivers a faster and deeper clean with a powerful oscillating jet.

HH4240

- ✓ 4200 PSI @ 4.0 GPM
- ✓ Belt-driven
- ✓ Built for long continuous running hours
- ✓ Perfect for facility, fleet, and property jobs that require extended cleaning times



SPECIFICATIONS	
ENGINE HONDA® GX390	PUMP AAA™ INDUSTRIAL TRIPLEX PUMP
PSI 4200	GPM 4.0
HOSE MONSTER™ STEEL-BRAIDED 3/8" x 50'	NOZZLES 0°, 15°, 25°, 40°, SOAP AND TURBO



Restrictions apply. See your Authorized Hustler Dealer for warranty details.



Innovative Pump Design
External unloader with external bypass for fast and easy maintenance as well as increased pump protection.



Strength & Flexibility
Dual-braided MONSTER Hose™. Polyurethane outer jacket. Non-marring. Three times more abrasion-resistant than rubber hose.



Maximum Cleaning
Turbo nozzle delivers a faster and deeper clean with a powerful oscillating jet.

HH4440

- ✓ 4400 PSI @ 4.0 GPM
- ✓ Powerful Honda® engine
- ✓ Reliable triplex pump
- ✓ Ultra-lightweight aircraft-grade aluminum frame
- ✓ Built to perform in a wide range of commercial cleaning applications



SPECIFICATIONS	
ENGINE HONDA® GX390	PUMP AAA™ INDUSTRIAL TRIPLEX PUMP
PSI 4400	GPM 4.0
HOSE MONSTER™ STEEL-BRAIDED 3/8" x 50'	NOZZLES 0°, 15°, 25°, 40°, SOAP AND TURBO



Restrictions apply. See your Authorized Hustler Dealer for warranty details.



Innovative Pump Design
External unloader with external bypass for fast and easy maintenance as well as increased pump protection.

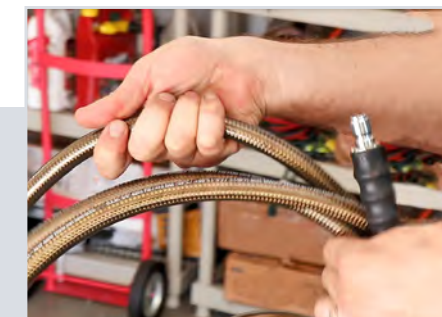

Strength & Flexibility
Dual-braided MONSTER Hose™. Polyurethane outer jacket. Non-marring. Three times more abrasion-resistant than rubber hose.



Maximum Cleaning
Turbo nozzle delivers a faster and deeper clean with a powerful oscillating jet.

PRESSURE WASHERS COMPARISON

HH4400

- ✓ 4400 PSI @ 4.0 GPM
- ✓ Powerful CRX engine
- ✓ Reliable triplex pump
- ✓ Ultra-lightweight aircraft-grade aluminum frame
- ✓ Built to perform in a wide range of commercial cleaning applications



SPECIFICATIONS	
ENGINE CRX420	PUMP AAA™ INDUSTRIAL TRIPLEX PUMP
PSI 4400	GPM 4.0
HOSE MONSTER™ STEEL-BRAIDED 3/8" x 50'	NOZZLES 0°, 15°, 25°, 40°, SOAP AND TURBO



Restrictions apply. See your Authorized Hustler Dealer for warranty details.



Innovative Pump Design
External unloader with external bypass for fast and easy maintenance as well as increased pump protection.



Strength & Flexibility
Dual-braided MONSTER Hose™. Polyurethane outer jacket. Non-marring. Three times more abrasion-resistant than rubber hose.



Maximum Cleaning
Turbo nozzle delivers a faster and deeper clean with a powerful oscillating jet.



	HH3324	HH3535	HH3725
ENGINE	Honda® GC190	CRX208	Honda® GX270
PSI	3300	3500	3700
GPM	2.4	2.5	2.5
HOSE	MorFlex™ 1/4" x 25'	MorFlex™ 5/16" x 25'	Monster Hose™ Steel-Braided 3/8" x 50'
PUMP	OEM Technologies Axial Cam Pump	AAA AX300 Commercial Axial Cam Pump	AAA Industrial Triplex Pump
NOZZLES	0°, 15°, 25°, 40°, Soap	0°, 15°, 25°, 40°, Soap and Turbo	0°, 15°, 25°, 40°, Soap and Turbo



	HH4035	HH4240	HH4400	HH4440
ENGINE	Honda® GX270	Honda® GX390	Honda® GX390	CRX420
PSI	4000	4200	4400	4400
GPM	3.5	4.0	4.0	4.0
HOSE	Monster Hose™ Steel-Braided 3/8" x 50'			
PUMP	AAA Industrial Triplex Pump			
NOZZLES	0°, 15°, 25°, 40°, Soap and Turbo			

Specifications are subject to change without notice.

PRESSURE WASHER ACCESSORIES

HOSES

MONSTER HOSE™



LENGTH	MAX PSI	TEMP	ID	FITTING
50"	4500	140° F	3/8"	3/8" QC
100"	4500	140° F	3/8"	3/8" QC



STRENGTH & FLEXIBILITY

Dual-braided MONSTER Hose™. Polyurethane outer jacket. Non-marring. Three times more abrasion-resistant than rubber hose.

MORFLEX™ HOSE



LENGTH	MAX PSI	TEMP	ID	FITTING
50"	3700	140° F	5/16"	M22*



LIGHTWEIGHT & FLEXIBLE

MorFlex™ Hose with a polyurethane jacket is up to three times more abrasion-resistant than rubber while remaining lightweight and kink-resistant.

* Includes hose adapter for connecting multiple hoses

GUNS

SPRAY GUN



DESCRIPTION	MAX PSI	MAX TEMP
SPRAY GUN WITH ERGONOMIC GRIP	4500	140° F

- ✓ Pro-style ergonomic design with side-assist grip and easy pull trigger for comfort and ease of use
- ✓ Includes a 3/8" quick-connect plug adapter so gun can connect to MONSTER and/or MorFlex hoses

PRO GUN HANDLE



DESCRIPTION	MAX PSI	MAX TEMP
SPRAY GUN WITH ERGONOMIC GRIP	5000	212° F

- ✓ Hot and cold water application capable
- ✓ Pro-style ergonomic design and easy pull trigger for comfort and ease of use
- ✓ Includes adapters so gun can connect to MONSTER and/or MorFlex hoses

NOZZLES

TURBO NOZZLES



DESCRIPTION	MAX PSI	TEMP	ID
OSCILLATING TURBO NOZZLE	3600	3.0	140° F
OSCILLATING TURBO NOZZLE	4500	4.0	140° F

- ✓ Creates a powerful jet of oscillating water
- ✓ Cleaning impact of a 0° nozzle

NOZZLE SETS

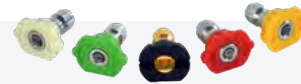

DESCRIPTION	MAX PSI	ORIFICE SIZE	MAX TEMP
SET OF FIVE SPRAY NOZZLES 0°, 15°, 25°, 40° AND SOAP	3600	3.0	140° F
SET OF FIVE SPRAY NOZZLES 0°, 15°, 25°, 40° AND SOAP	4500	4.0	140° F

- ✓ Universal to fit pressure washers with quick-connect spray wands
- ✓ Array of spray patterns from pin-point for tough jobs, to wide-fan for maximum coverage

LANCES

SPRAY LANCE



DESCRIPTION	MAX PSI	MAX TEMP
16" SPRAY LANCE	3600	140° F
31" SPRAY LANCE	4500	140° F

- ✓ 1/4" quick-connect for easy attachment of spray tips and other accessories
- ✓ Cold-water applications only

INSULATED LANCE



DESCRIPTION	MAX PSI	MAX TEMP
48" INSULATED LANCE	5000	212° F

- ✓ 1/4" quick-connect for easy attachment of spray tips and other accessories
- ✓ Insulated for hot-water applications

SCRUBBERS

SURFACE SCRUBBER



DESCRIPTION	MAX PSI	DIAMETER
SURFACE SCRUBBER	3600	15"

- ✓ Cleans large surfaces including garage floors, driveways, patios, and decks quickly and uniformly
- ✓ High-quality assembly includes powder-coated steel shroud and stainless steel nozzles
- ✓ Two high-pressure nozzles for quick streak-free cleaning

SURFACE SCRUBBER

DESCRIPTION	MAX PSI	DIAMETER
SURFACE SCRUBBER	4500	20"

- ✓ Equipped with in-line filter to prevent nozzle obstruction and pump damage
- ✓ Two high-pressure stainless steel nozzles for quick streak-free cleaning

INVERTERS & GENERATORS

INVERTERS & GENERATORS

Hustler® Turf portable generators and inverters are engineered to perform and built to last. Perfect for providing power at worksites, recreational facilities, residential locations, and more. Whether tailgating before a game, charging tools at a construction site, or providing backup power for your home, Hustler gets the job done.



HIG2200

- ✓ LED warning lights for low oil & power overload
- ✓ 8-hour run time at 50% load
- ✓ Sound pressure level: 53 dB(A) at 23 feet



SPECIFICATIONS

ENGINE HUSTLER®	ENGINE CC 79cc
STARTING WATTS 2200	FUEL TANK CAPACITY 1.2 GAL

COMMERCIAL
1 YEAR LIMITED ENGINE WARRANTY

3 YEAR LIMITED WARRANTY CONSUMER

180 DAY LIMITED WARRANTY COMMERCIAL

Restrictions apply. See your Authorized Hustler Dealer for warranty details.

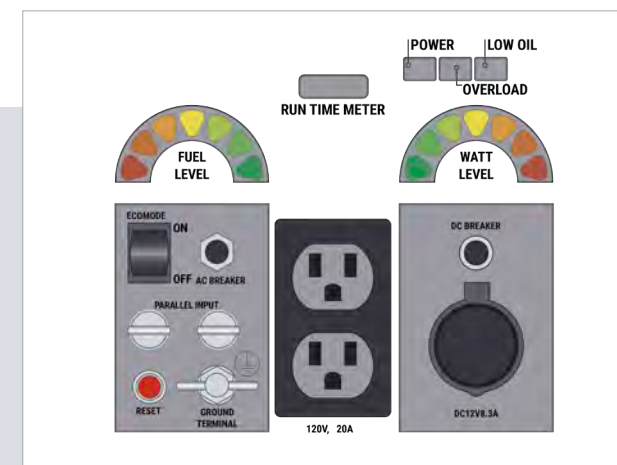

Parallel Kit
(inverter accessory)

HIG3632E

- ✓ LED warning lights for low oil & power overload
- ✓ 8-hour run time at 50% load
- ✓ Sound pressure level: 70 dB(A) at 23 feet



SPECIFICATIONS	
ENGINE HUSTLER®	ENGINE CC 212cc
STARTING WATTS 3600	FUEL TANK CAPACITY 1.5 GAL

COMMERCIAL
1 YEAR LIMITED ENGINE WARRANTY

3 YEAR LIMITED WARRANTY CONSUMER

180 DAY LIMITED WARRANTY COMMERCIAL

Restrictions apply. See your Authorized Hustler Dealer for warranty details.

HIG4540E

- ✓ LED warning lights for low oil & power overload
- ✓ 8-hour run time at 50% load
- ✓ Sound pressure level: 72 dB(A) at 23 feet



SPECIFICATIONS	
ENGINE HUSTLER®	ENGINE CC 223cc
STARTING WATTS 4500	FUEL TANK CAPACITY 2.4 GAL

COMMERCIAL
1 YEAR LIMITED ENGINE WARRANTY

3 YEAR LIMITED WARRANTY CONSUMER

180 DAY LIMITED WARRANTY COMMERCIAL

Restrictions apply. See your Authorized Hustler Dealer for warranty details.

HPGH5500

- ✓ Low-oil engine shutdown protection
- ✓ Less than 5% harmonic distortion (THD) for safely running sensitive electronics
- ✓ GFCI protection
- ✓ Copper alternator windings
- ✓ Convenient fold-down handle for easy maneuverability & storage
- ✓ Durable never-flat tires
- ✓ Sound pressure level: 76 dB(A) at 23 feet



SPECIFICATIONS	
ENGINE HONDA® GX270	ENGINE CC 270cc
STARTING WATTS 5500	FUEL TANK CAPACITY 8 GAL

3 YEAR LIMITED WARRANTY CONSUMER

1 YEAR LIMITED WARRANTY COMMERCIAL

3 YEAR LIMITED ENGINE WARRANTY + **2** YEAR LIMITED EXTENDED MANUFACTURER WARRANTY = **5** YEAR TOTAL ENGINE PROTECTION

Restrictions apply. See your Authorized Hustler Dealer for warranty details.

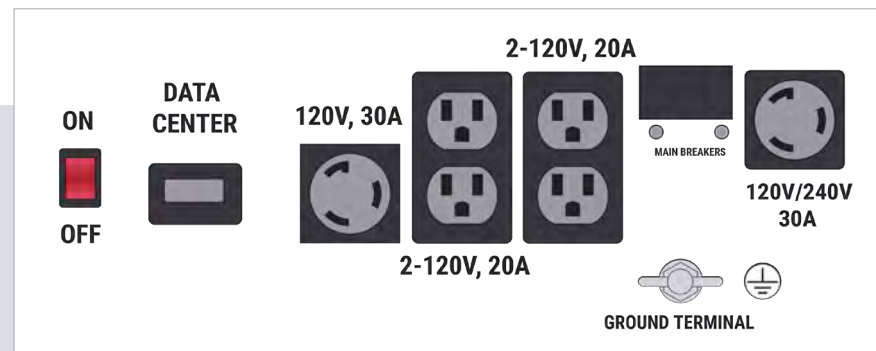

HPGH8500

- ✓ Low-oil engine shutdown protection
- ✓ Less than 5% harmonic distortion (THD) for safely running sensitive electronics
- ✓ GFCI protection
- ✓ Convenient fold-down handle for easy maneuverability & storage
- ✓ Durable never-flat tires
- ✓ Copper alternator windings
- ✓ Sound pressure level: 80 dB(A) at 23 feet



SPECIFICATIONS	
ENGINE HONDA® GX390	ENGINE CC 389cc
STARTING WATTS 8500	FUEL TANK CAPACITY 8 GAL

3 YEAR LIMITED WARRANTY CONSUMER

1 YEAR LIMITED WARRANTY COMMERCIAL

3 YEAR LIMITED ENGINE WARRANTY + **2** YEAR LIMITED EXTENDED MANUFACTURER WARRANTY = **5** YEAR TOTAL ENGINE PROTECTION

Restrictions apply. See your Authorized Hustler Dealer for warranty details.

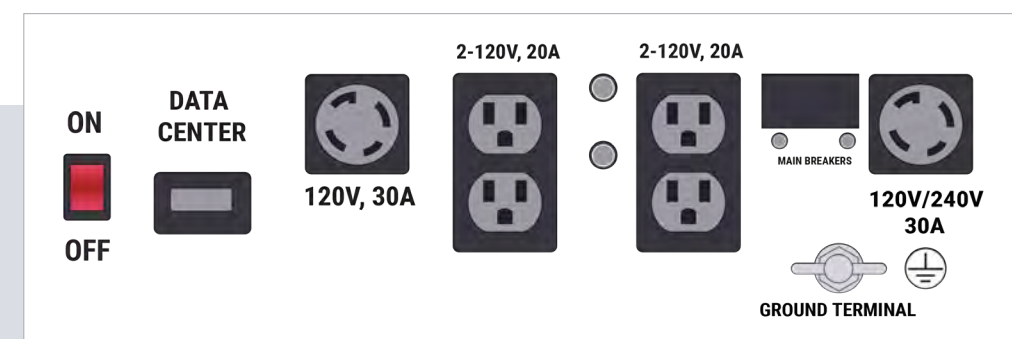

HPGH8500E

- ✓ Electric start
- ✓ Low-oil engine shutdown protection
- ✓ Less than 5% harmonic distortion (THD) for safely running sensitive electronics
- ✓ GFCI protection
- ✓ Convenient fold-down handle for easy maneuverability & storage
- ✓ Durable never-flat tires
- ✓ Copper alternator windings
- ✓ Sound pressure level: 80 dB(A) at 23 feet



SPECIFICATIONS	
ENGINE HONDA® GX390	ENGINE CC 389cc
STARTING WATTS 8500	FUEL TANK CAPACITY 8 GAL



Restrictions apply. See your Authorized Hustler Dealer for warranty details.

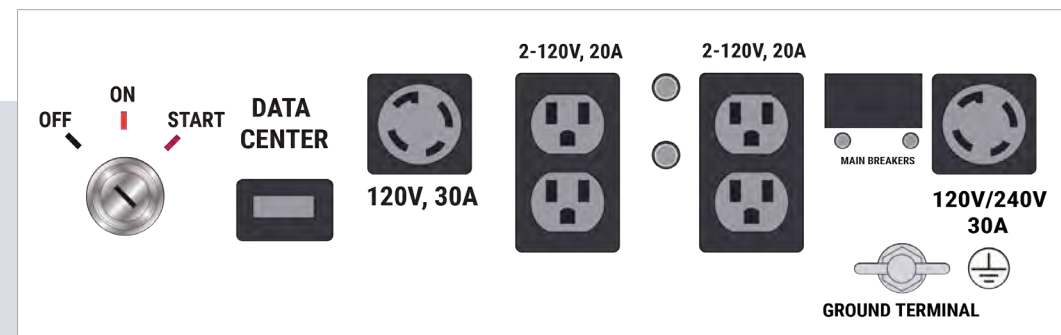

	HIG2200	HIG3632E	HIG4540E
ENGINE	Hustler®	Hustler®	Hustler®
ENGINE CC	79cc	212cc	223cc
RUN TIME (50%)	8 HRS	8 HRS	8 HRS
RUNNING WATTS	1800	3200	4000
STARTING WATTS	2200	3600	4500
FUEL TANK CAPACITY	1.2 GAL	1.5GAL	2.4GAL
AUTO ENGINE SHUTOFF	N	N	N
ELECTRIC START	N	Y	Y

GENERATOR COMPARISON



	HPGH5500	HPGH8500	HPGH8500E
ENGINE	Honda® GX270	Honda® GX390	Honda® GX390
ENGINE CC	270cc	389cc	389cc
RUN TIME (50%)	-	-	-
RUNNING WATTS	4500	7500	7500
STARTING WATTS	5500	8500	8500
FUEL TANK CAPACITY	8 GAL	8 GAL	8 GAL
AUTO ENGINE SHUTOFF	Y	Y	Y
ELECTRIC START	N	N	Y

Specifications are subject to change without notice.

HUSTLER FLUID PRODUCTS

Hustler Turf's motor oil, fuel stabilizer and hydrostatic transmission oil products will help keep your machine running smoothly. Ask your local dealer about availability of these products.



TRANSMISSION OIL

- ✓ Guards against heat, sludge and harmful deposits
- ✓ Excellent hot and cold-weather performance
- ✓ Strong anti-wear protection
- ✓ Helps maintain tight pump and motor tolerances which keep the transmission operating efficiently



FUEL STABILIZER

- ✓ Triple corrosion protection for longer lasting engine components
- ✓ Prevents gasoline oxidation for easier starts after storage or downtime
- ✓ Effective in all gasoline, including ethanol blends
- ✓ Powerful antioxidants to help prevent acids from forming



ENGINE OIL

- ✓ Anti-wear additive package that protects engines from harmful wear
- ✓ Detergent/dispersant content maintains engine cleanliness
- ✓ Excellent hot and cold-temperature performance
- ✓ Multi-viscosity oil helps extend engine life and increase performance



Visit hustlerturf.com/find-a-retailer to locate your nearest dealer.



HUSTLER®

©2022 HUSTLER TURF EQUIPMENT

SPECIFICATIONS SUBJECT TO CHANGE WITHOUT NOTICE.
VISIT [HUSTLERTURF.COM](https://www.hustlerturf.com) FOR THE MOST CURRENT
SPECIFICATIONS. 4-22

[HUSTLERTURF.COM](https://www.hustlerturf.com)