

Technical sheet :

MRT 3570

VISION +



| Capacities | | Metric |
|--|-----------|--|
| Max. capacity | | 7000 kg |
| Max. lifting height | | 34.70 m |
| Max. Reach | | 28 m |
| Weight and dimensions | | |
| Overall width | b1 | 2.50 m |
| Overall height | h17 | 3.26 m |
| Overall cab width | b4 | 0.96 m |
| Ground clearance | m4 | 0.36 m |
| Wheelbase | y | 3.75 mm |
| Tilt-up angle | a4 | 11 ° |
| Tilt-down angle | a5 | 113 ° |
| Turret rotation | | 360 ° |
| Overall weight | | 23800 kg |
| Forks length / width / section | l / e / s | 1200 mm x 125 mm x 60 mm |
| Wheels | | |
| Standard tyres | | 17,5_R25 |
| Drive wheels (front / rear) | | 2 / 2 |
| Steering mode | | 2 wheel steer, 4 wheel steer, Crab mode |
| Stabilisers | | |
| Stabs Type | | Telescopic Triplex |
| Controls with stabs | | Stabs Commands Individual or Simultaneous |
| Engine | | |
| Engine brand | | Yanmar |
| Engine norm | | EU Stage V / US EPA Tier 4 |
| Engine model | | 4TN107FTT-6SMU2 |
| I.C. Engine power rating / Power (kW) | | 211 Hp / 155 kW |
| Max. torque / Engine rotation (min) | | 805 Nm @ 1500 rpm |
| Number of cylinders - Capacity of cylinders | | 4 - 4567 cm³ |
| Engine cooling system | | Water cooled |
| Number of batteries / Battery / Batteries capacity | | 2 x 12 V / 120 Ah |
| Battery starting current | | (EN)850 A |
| Transmission | | |
| Transmission type | | Hydrostatic with CVT |
| Gearbox | | Speedshift |
| Max. travel speed | | 40 km/h |
| Parking brake | | Automatic negative parking brake |
| Service brake | | Oil-immersed multi-discs braking on front & rear axles |
| Hydraulics | | |
| Hydraulic pump type | | Load sensing pump |
| Hydraulic flow | | 185 l/min |
| Hydraulic Pressure | | 350 Bar |
| Tank capacities | | |
| Engine oil | | 13 l |
| Hydraulic oil | | 300 l |
| Fuel tank | | 320 l |
| Diesel Exhaust fluid (AdBlue® type) | | 24 l |
| Miscellaneous | | |
| Steering wheels (front / rear) | | 2 / 2 |
| Controls | | 2 Joysticks |
| Safety cab homologation | | ROPS - FOPS cab (level 2) |
| Attachment recognition system (E-Reco) | | Standard |

Dimensional drawing

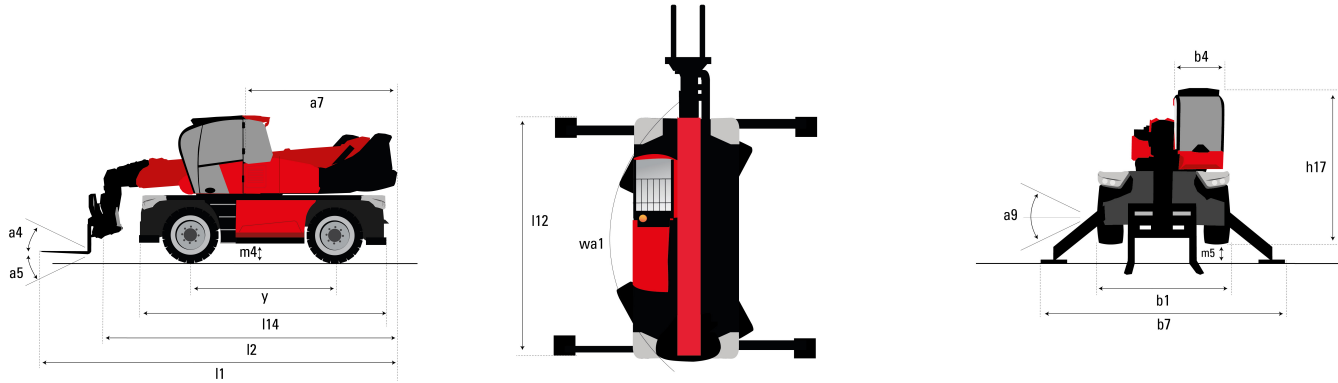

| Other data | | Metric |
|---|-----|---------|
| Overall length (with forks) | l1 | 10.06 m |
| Length to face of forks | l2 | 8.86 m |
| Length of frame | l14 | 6.82 m |
| Wheelbase | y | 3.75 m |
| Ground clearance | m4 | 0.36 m |
| Counterweight offset (turret at 90°) | a7 | 3.74 m |
| Tilt-up angle | a4 | 11° |
| Tilt-down angle | a5 | 113° |
| Overall length at stabilisers | l12 | 6.49 m |
| External turning radius (over tyres) | wa1 | 4.91 m |
| Overall width | b1 | 2.50 m |
| Overall width with stabilisers extended | b7 | 7.40 m |
| Overall cab width | b4 | 0.96 m |
| Overall height | h17 | 3.26 m |
| Frame levelling corrector | a9 | +/- 8° |
| Ground clearance under front tires on stabilizers | m5 | 0.45 m |

Load chart

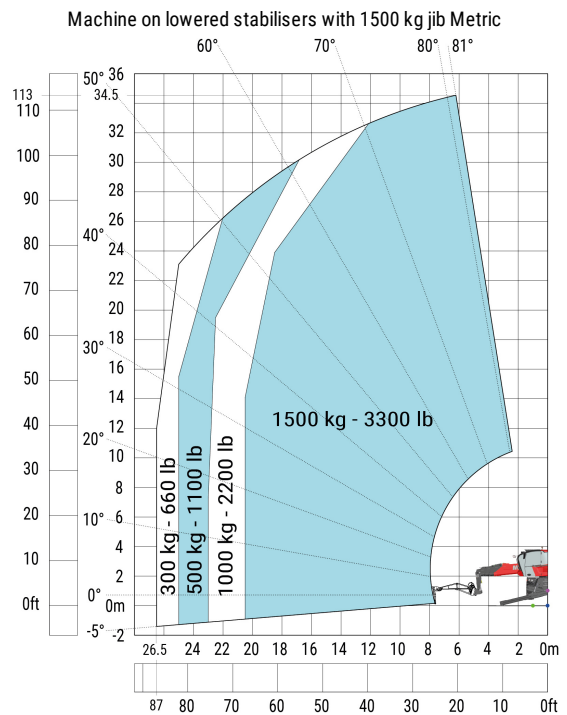
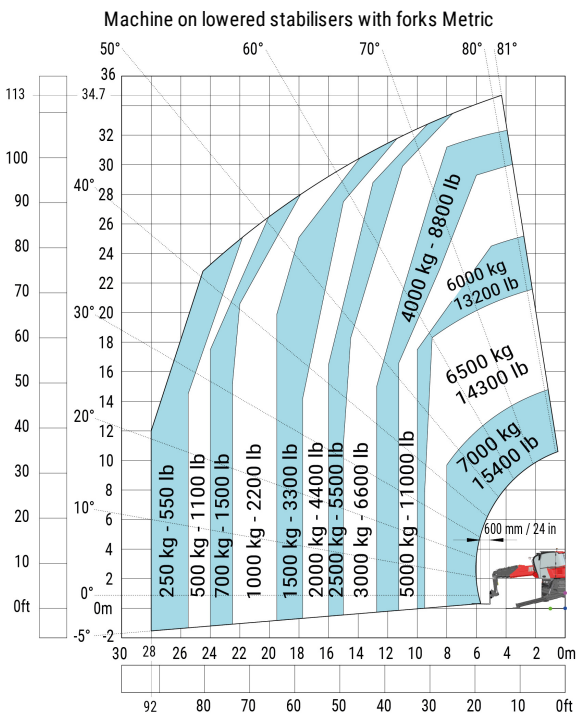

Machine on lowered stabilisers with 365 kg platform Metric

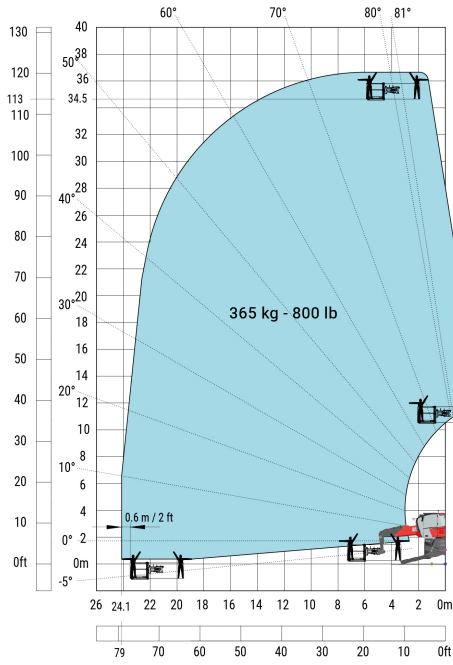

Machine on lowered stabilisers with 3D positive Metric

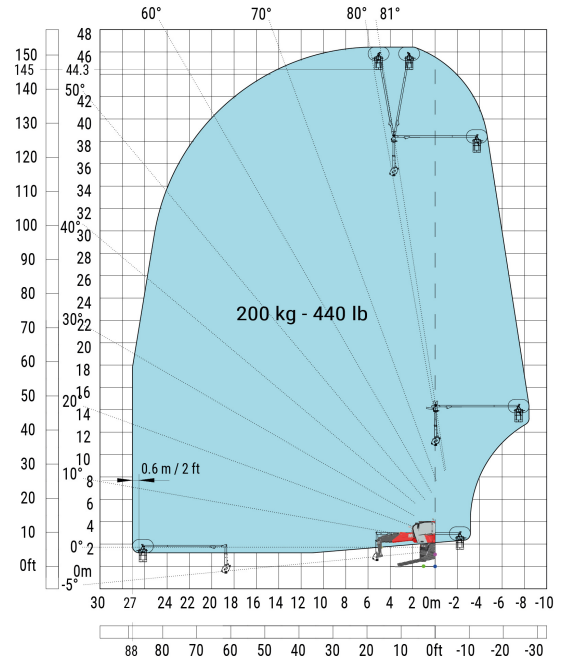

Machine on lowered stabilisers with hook 9000 kg (Metric)

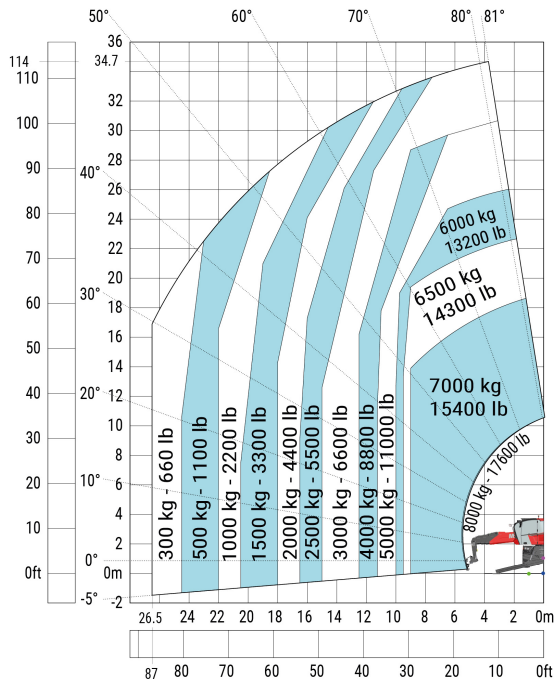

Machine on tyres with forks Metric

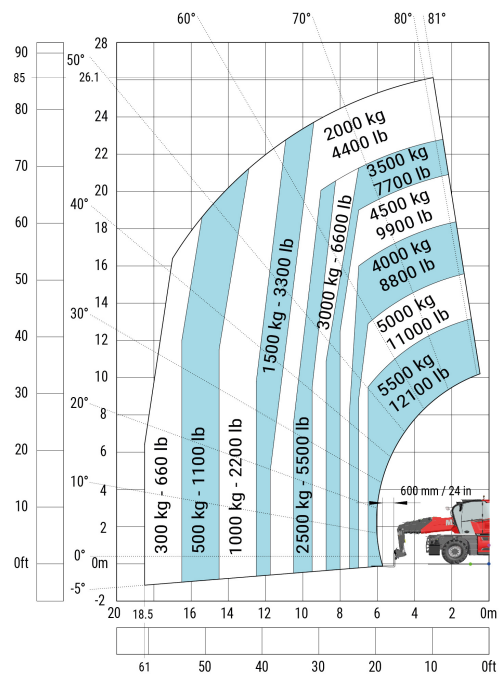

Machine on lowered stabilizers with winch 7200 kg (metric)

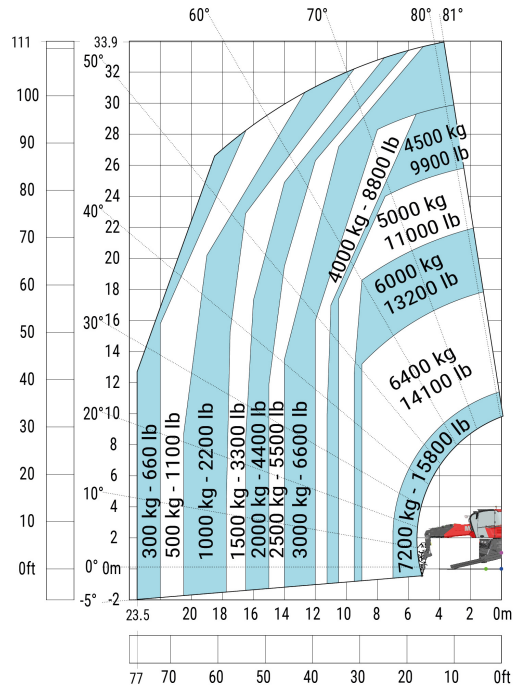

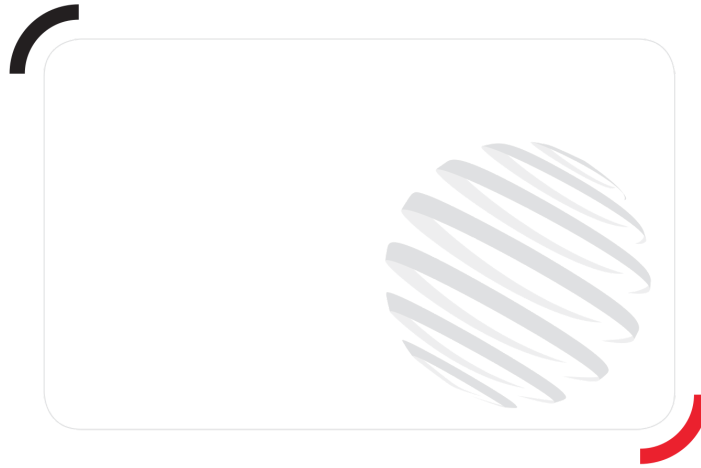

Siège Social

430 rue de l'Aubinière - 44150 Ancenis Cedex - France

Tel: +33(0)2 40 09 10 11 - Fax: +33 (0)2 40 09 10 97

www.manitou.com



This brochure describes versions and configuration options for Manitou products which may be fitted with different equipment. The equipment described in this brochure may be standard, optional or not available depending on version. Manitou reserves the right to change the specifications shown and described at any time and without prior warning. The manufacturer is not liable for the specifications given. For more information, contact your Manitou dealer. Non-contractual document. Product descriptions may differ from actual products. List of specifications is not comprehensive. The logos and visual identity of the company are the property of Manitou and may not be used without authorisation. All rights reserved. The photos and diagrams contained in this brochure are provided for information only.

MANITOU BF SA - Limited company with board of directors - Share capital: 39,668,399 euros - 857 802 508 RCS Nantes