

JOSKIN

EN

HEAVY DUTY RANGE



www.joskin.com

*SUITED FOR THE **HARDEST** WORK!*

THE JOSKIN QUALITY: 6 Keys to Success



Production site (Belgium)

Strength of EXPERIENCE

FOUNDED IN 1968, the JOSKIN family business became A LEADER in the design and manufacture of agricultural machines. SPREAD OVER BELGIUM, POLAND AND FRANCE on a total surface area of almost 150,000 m², the JOSKIN production sites are EXPORTING TO MORE THAN 60 COUNTRIES.



TECHNICAL SKILLS within

VERY MODERN AND HIGHLY PRECISE TECHNIQUES are used: dynamic 3D simulation, automated lasers, folding presses, high tensile steel, hot-dip galvanization, automated continuous weldings.



Buy with CONFIDENCE



See conditions on www.joskin.com





Technical Centre (Poland)



RESEARCH and DEVELOPMENT

JOSKIN has its own industrial design offices and 3D static and dynamic engineering software. The production is standardized as much as possible in order to ensure a precise manufacturing and a deadline compliance, while proposing hundreds of options! Our technicians and dealers are constantly trained in our technical centers.



At the SERVICE of our customers

Our great strength: the AVAILABILITY OF SPARE PARTS at any time and anywhere. Thanks to our permanent stocks, we send your parts as quickly as possible. The JOSKIN dealers undertake to have a stock of the most important spare parts of the machines.

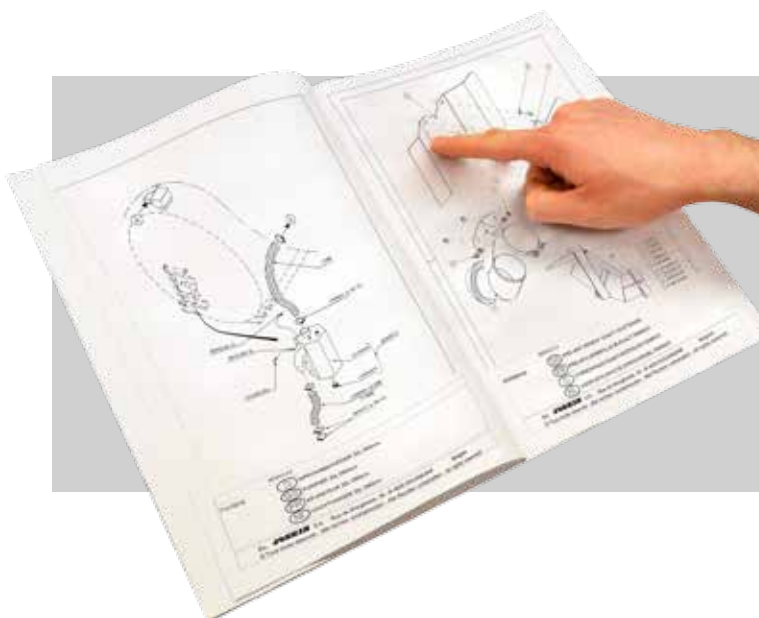

Individualized PARTS book

The PARTS BOOK and the USER'S MANUAL are provided in your language when purchasing a machine. The parts book includes the drawings and references of the components mounted on your machine. Even years later, spare parts can be ordered efficiently!

Heavy Duty Range



Advanced Technique

The steel processing knowledge and the material choice are essential. Special steel types with high tensile limit allow to reduce – or even remove – the crosspieces and side reinforcements. Vehicles are in this way lighter, stronger and benefit from clear and elegant lines. The steel sheets are processed by modern tools like a 8 m laser cutting table, a 8.2 m folding press with digital control and automatic folding angle correction device (making sure the steel plate is evenly folded on the whole length), 8 m welding robots, etc.



Lathe with digital control



Welding robot



Laser cutting table



Folding machine with digital control

Adapted Special and High-Tensile Steel

JOSKIN machines are fully made of high tensile steel types, such as HARDOX®. The constant search for the best steel quality/weight ratio has led to a significant decrease in the empty weight of the JOSKIN machines, while increasing their sturdiness. It is therefore possible to transport ever higher payloads.

Careful Manufacturing

JOSKIN tipping trailers are manufactured in accordance with the company's production philosophy. The many automated tools ensure an endless precision.

In the same way, the assemblies are exclusively mounted and welded on jigs. All components, including the body, are continuously welded. Surface treatment is very carefully carried out: the item is first cleaned by shot-blasting (projection of 2,500 kg of steel balls/minute) and then covered by an Ester Epoxy primer and finally a 2-component finishing coating. As part of the process, the paint is then dried at 60 °C.



The following table aims at comparing the general specifications of the steel types used by JOSKIN:

Specifications of the steel types used by JOSKIN vs. traditional steel		
Type of steel	Tensile limit (kg/mm ²)	Ultimate stress (kg/mm ²)
S235 or St 37-2 (traditional steel)	23.5	40
S355 or St 52-3 (traditional steel)	35.5	48
S420 (JOSKIN high-tensile steel)	42	55
S550 (JOSKIN high-tensile steel)	55	61
S690 (JOSKIN high-tensile steel)	69	75
HARDOX 450 (KTP HARDOX)	120	140





WIN PACK

"Win Pack" Advantages

To combine quality manufacturing and shortened delivery time, JOSKIN proposes WIN PACK machines. They are:

- reliable and of high quality thanks to the standardized manufacturing process;
- adapted to your farm and affordable;
- in stock or rapidly available;
- fitted with pieces of equipment that were tested in real working conditions;
- modular given the many options.



Front lifting axle - standard on Hydro-Tridem

TRANS-KTP 9, 11 and 15 T



Choosing
multi-functionality
and Sturdiness



DESIGN

The chassis of the JOSKIN Trans-KTP 9, 11 and 15 T tipping trailers is 900 mm wide and it can therefore be fitted with wide wheels. It is made up of 250 x 100 x 6 mm profile tubes on models 9/45 and 11/45, and of 300 x 100 x 8 mm profile tubes on model 15/45. The driving comfort provided by the whole carriage is ensured by the hitching suspension with cross-springs.

HITCHING

The Trans-KTP 9, 11 and 15 T are fitted with an open drawbar that, given its structure, ensures a very good weight/resistance ratio. Its wide fixing points (same width as the chassis) further improves the manoeuvrability.

This solution offers a straight pull/push line and a large vertical clearance at the eyelet, thereby largely absorbing shocks.



GENERAL POINTS

The JOSKIN Trans-KTP 9, 11 and 15 T construction trailers are the "low-capacity" models of the JOSKIN heavy duty range.

Given their compact and sturdy design (side walls and floor in HARDOX steel), they are an ideal solution for small earthmoving works, landscape gardening contractors or even public services.

They are pre-equipped to be fitted with two optional aluminium ramps, thereby allowing to load and transport a small excavator.



SPECIFICATIONS

Chassis	Width 900 mm
	• 9/45 - 11/45: 250 x 100 x 6 mm • 15/45: 300 x 100 x 8 mm
Body	Monocoque
	Floor and side walls:
	• 4 mm HARDOX 450 for 9/45 and 11/45 • 5 mm HARDOX 450 for 15/45
Running gear	JOSKIN Roll-Over
	Drawbar with parabolic suspension leaves
Max. wheel dimensions	Ø 1,248 mm / width 645 mm

MODELS

	DIN volume (m ³)	Technically permissible payload	Inner body dimensions (m)				Height	Axle(s): □ (mm) - track (mm) - studs	Brakes (mm)	Ram (l)
			Length under	Length above	Width front	Width back				
9/45 ⁽¹⁾	5.10	9 t	4.50	4.60	2.18	2.26	0.50	ADR 130x2000-10S	406 x 120	19
11/45 ⁽¹⁾	5.10	11 t	4.50	4.60	2.18	2.26	0.50	ADR 2x90x1900-8S	350 x 60	19
15/45 ⁽¹⁾	7.60	15 t	4.50	4.60	2.18	2.26	0.75	ADR 2x100x2000-10S	400 x 80	27

⁽¹⁾ The first 2 figures refer to the carrying capacity in tons and the next 2 ones to the length of the body. The max. total load depends on the legislation in force in each country.



TRANS-KTP 17, 22 and 27 T

Combining
Agility and
High Capacity



GENERAL POINTS

The Trans-KTP 17, 22 and 27 T tipping trailer models are conceived and designed for the hardest works. Their body with side walls, floor and door fully made of 6 mm HARDOX 450 (5 mm for 17/50) ensures their long life span.

The double-axle models are standard fitted with the JOSKIN Cross-Over bogie and the 27/65 TRM with the Hydro-Tridem hydraulic suspension. These running gears ensure a high driving comfort on uneven ground.

Furthermore, the 27/65 TRM is standard fitted with a double self steering system (first and last axle), which further improves the manoeuvrability.

All these models are also standard fitted with a bumper that retracts hydraulically as the door opens.

SPECIFICATIONS

Chassis	Width 900 mm
	<ul style="list-style-type: none"> • 17/50 - 22/50 - 27/55: 300 x 150 x 8 mm • 27/65 TRM: 300 x 150 x 10 mm
Body	Monocoque Floor and side walls:
	<ul style="list-style-type: none"> • 5 mm HARDOX 450 for 17/50 • 6 mm HARDOX 450 for 22/50 - 27/55 - 27/65
Running gear	<ul style="list-style-type: none"> • JOSKIN Cross-over on 17/50 - 22/50 - 27/55 • Hydro-Tridem on 27/65 • Options: JOSKIN rocker beam, Hydro-Pendul or Hydro-Tandem
	<ul style="list-style-type: none"> • Max. wheel dimensions: Ø 1,450 mm / width 666 mm • Ø 1.400 mm / width 800 mm

NARROW CHASSIS

JOSKIN developed a narrow chassis that allows to fit the Trans-KTP with wide wheels (up to 666 mm), while not exceeding a total width of 2,550 mm. It also provides a larger steering angle and can be fitted with a more efficient braking system.

Regarding safety and stability of the vehicle, the front ram is as efficient as the one in standard position.



MODELS

	Technically permissible payload	DIN volume (m ³)	Length under	Inner body dimensions (m)			Height	Axle(s): □ (mm) - track (mm) - studs	Brakes (mm)	Ram (l)
				Length above	Width front	Width back				
17/50 ⁽¹⁺⁴⁾	17 t	8.6	5.06	5.28	2.18	2.26	0.75	ADR 2x130x1950-10S	406 x 120	26
22/50 ⁽¹⁾	22 t ⁽²⁾	10.9	5.06	5.28	2.18	2.26	0.95	BPW 2x150x1950-10S	410 x 180	36
27/55 ⁽¹⁺³⁾	27 t	11.9	5.54	5.75	2.18	2.26	0.95	BPW 2x150x1950-10S	410 x 180	42
27/65TRM ⁽¹⁺³⁾	27 t	13.9	6.49	6.70	2.18	2.26	0.95	BPW 3x150x2100-10S	410 x 180	70

⁽¹⁾ The first 2 figures refer to the carrying capacity in tons and the next 2 ones to the length of the body.

⁽²⁾ For France: option 310 (1.820 mm bogie leaves) compulsory to get a maximum weight allowed to a loaded vehicle of 29 t for the 22/50.

⁽³⁾ For France: only max. total load of 24 t. ⁽⁴⁾ Certification in progress for France. The max. total load depends on the legislation in force in each country.

CONSTRUCTION TIPPING TRAILER

General Points and Options



Tapered, Light and Strong Body

The bodies of the JOSKIN Trans-KTP construction trailers are made fully of high tensile steel of the HARDOX 450 type, which has very interesting tensile properties, as it takes its initial shape back after deformation. Compared to traditional steel, its tensile limit is indeed 4 to 5 times higher.

All bodies, including the doors, are manufactured with 2 steel sheets, without any linking cross-weld. Thanks to this manufacturing process, the empty weight of these tipping trailers is significantly lower and therefore allows transportation of higher payloads, without compromising on sturdiness.

The tapered shape of the body makes sure the contents of the trailer flow out freely. This unmatched property is further reinforced by the successive folds aiming at smoothing off the edges of the body.

Tipping

The telescopic tipping ram is mounted on a double oscillating frame fitted with greased bearings and integrated in the chassis at a more forward position. This system compensates the torsions due to the tipping strains and effectively protects the ram and body from distortions. The body tipping is also ensured by the two robust hinges including bolted axis with large diameter. The back- and upwards position of the hinges increases the unloading height.

The standard mounted safety valve, which is directly placed on the tipping ram, prevents the body from unexpectedly falling down (e.g. when the hydraulic hoses break).



Anchoring point of the ram on the body



Double oscillating frame in which the ram is placed

Tipping accessories

It is also possible to choose a front tipping ram instead of the one under the body for models 22/50 (36 l), 27/55 (49 l) and 27/65 (76 l). This option requires a galvanized headboard in order to protect the ram.



JOSKIN PRINCIPLE

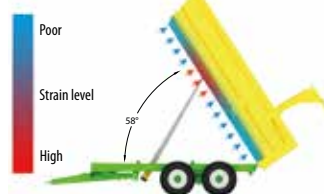

OTHER

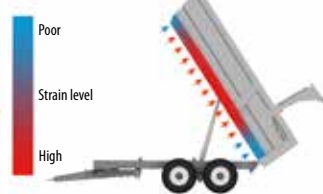

An industrial hydraulic pump (150 l/min) with electric tipping and lowering control (1,000 rpm) can replace the tipping function directly connected to the hydraulic system of the tractor. This pump has a "quick lowering" function and is part of the standard equipment on the 27/65 TRM model.

For models 9, 11 and 15 T, two hydraulic pumps with a 55 l capacity are available (PR660: 53 l/min at 1,000 rpm and PR980: 70 l/min at 1,000 rpm). They can optionally be fitted with an electric or hydraulic control.



Parking Stand

The skid is hydraulically unfolded and can be completely integrated into the drawbar to ensure a larger clearance.

Headboard

As an option, the body can be fitted with a fully galvanized headboard in order to protect the hitching gear, the tractor and the tipping ram against possibly falling matter.

Hydraulic Door

The tipping operation is made easier and quicker thanks to the hydraulic door (which is fully made of HARDOX 450 on 17, 22 and 27 T as a standard) with maximum opening angle. The door is linked by three fixing points to the arms that pivot on a sturdy axis with a large diameter. Finally, the rams are mounted under the arms for protection purposes.

The doors of the JOSKIN tipping trailers are fitted with two safety devices:

- In order to prevent system damage, a pressure relief valve regulates the oil pressure if the door cannot be completely closed, e.g. due to an obstacle.
- A safety valve on each door ram holds the door in position if hydraulic hoses break or if the tractor stops.



A 2-part rear door (also fully made of high tensile steel standard on 17, 22, 27 T - in option on 9, 11, 15 T) with 400x400 mm grain chute is available as an option.

Working Lights

Rear working lights integrated into the chassis and a flashing beacon (or LED flash light) are available as an option.

Protecting Strip

A PVC protection of the upper body strip is proposed as an option to reduce the risks of potential damages by loading tools.

Aluminium Extensions

250 or 500 mm aluminium extensions can be mounted in order to increase the loading capacity. A grain chute can be mounted on one of the rear door sides.



Cover Systems

On the Trans-KTP tipping trailers, there are three solutions to cover the body: the VAKO rigid cover made up of two doors with hydraulic closing, the Flip-Tarp net with hydraulic closing and a cover with manual or hydraulic winding.



VAKO cover system



Flip-Tarp



Cabriolé cover

CONSTRUCTION TIPPING TRAILER

JOSKIN Running Gears, a Reference!



Rock Solid Running Gears

JOSKIN running gears are designed to meet, in every situation and whatever the vehicle, the criteria of reliability, stability, comfort and safety both on roads and in the fields.

Manoeuvrability

For enhanced manoeuvrability and optimal driving comfort, JOSKIN proposes two types of steering axle: the free steering axle and the self steering axle.

Safety

There are many braking system options. The air braking system can replace the hydraulic one and they also can be combined. Moreover, the load-proportional braking system ensures an improved safety and driving comfort.

Dynamic Weighing System on Hydraulic Suspension

Vehicles fitted with a hydraulic hitching suspension and a hydraulic running gear can be fitted with this device.

Two pressure sensors located on the hydraulic circuit of the running gear, as well as one on the hitching suspension, are connected to a computer on the running gear. These sensors send cable signals so that the weight can be displayed on a screen in the tractor cabin. Another screen can be installed on a loader or on the vehicle in order to see the load weight at any time. This system is also compatible with Isobus and can be controlled through the Isobus terminal that replaces in this case the separate screen. It is available on tipping trailers, muck and slurry spreaders, multi-purpose and silage trailers.

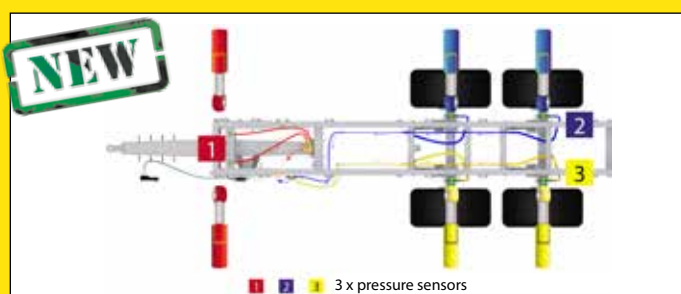

A Choice of 5 Running Gear Types:

ROLL-OVER BOGIE

The bogie, which is mounted on 11 and 15 T models, is made up of 2 axles linked by parabolic leaves and fixed to the chassis by means of a central point. This concept makes it possible to counterbalance the ground unevenness (up to +/- 250 mm). Thanks to the position of the cross-axis (under the leaves) and the upper position of the axles at the ends of the leaves, the drawline pushes the front axle over the obstacle. The traction power needed is therefore reduced.

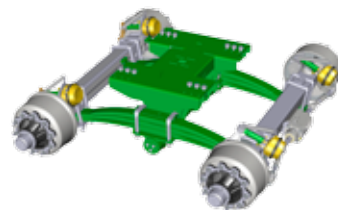

CROSS-OVER BOGIE

The Trans-KTP 17, 22 and 27 T tipping trailers are standard fitted with the JOSKIN Cross-Over bogie. It is specially designed to provide the vehicle with the best compromise between ground clearance and traction ease and to meet the specific requirements of the most demanding works. The pivot point on the Cross-Over and Roll-Over bogies lies under the leaves, which provide a further improved suspension quality because of their outstanding resistance to torsions.

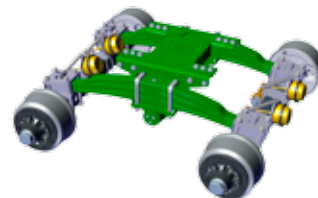

ROCKER BEAM

The rocker beam is available as an option on the 22 and 27 T double-axle models. It consists of two large casings made up of profile tubes (300 x 300 x 12.5 mm) each supporting two half-axles. They are hinged on a central axis (mounted on bushes with grease nipples) and a monoblock table bolted to the chassis.





HYDRO-TANDEM AND HYDRO-TRIDEM

Simplicity, clearance and stability: these are the three key specifications of the Hydro-Tandem/Tridem running gear. It combines the following advantages: the axles can easily be pulled over obstacles and they are semi-independent. That is why they allow a significant clearance (up to +/- 250 mm). The stability of the vehicle will therefore also be significantly improved. Each axle is pulled by leaves attached to a fixing element that is located ahead of the assembly. Four or six hydraulic rams are placed two by two or three by three on both sides of the chassis. The first lifting axle is standard mounted on all Hydro-Tridem vehicles.



HYDRO-PENDUL

On the Hydro-Pendul hydraulic suspension, each axle is mounted on two double-acting hydraulic rams (one on each side of the chassis) and is linked to the chassis by a triangular structure of tubes with a large diameter, the end of which is fastened to an imposing knee-joint, which has a vertical axis in order to make the running gear highly stable.

On the Hydro-Pendul, you can secure your tipping operation with the option "Tipping stabilizer". Its purpose is to lock the hydraulic rams in order to keep them perfectly aligned.

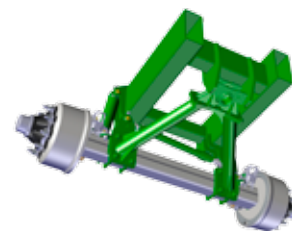

Free Steering Axles

The free steering axle follows the direction taken by the tractor. The oscillation range is +/- 15° depending on the tyre size

To drive on the road (> 15 km/h) or reverse, an hydraulic device ensures a powerful locking and a perfect alignment of the rear axle with the front axle, which thereby ensures the safety of the carriage. A shock-absorber stands for the stability of the free steering axle by preventing too significant vibrations.

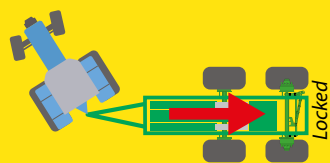

Free steering axles
(50% steering)

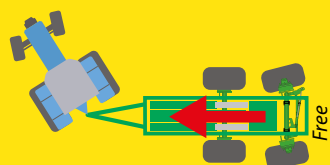

Self Steering Axles

The self steering axle is an important safety component as it keeps your vehicle in the tractor driving line. JOSKIN triple-axle vehicles are standard fitted with a double self steering system (first and last axles) operating in both directions (forward and reverse).

The axle cylinder is operated by a sensor cylinder linked to the tractor by a hitching rod with quick coupling. This one is anchored to the drawbar by means of a knee-joint and controls the hydraulic circuit operating the steering cylinder. The system is balanced by the compensated cylinders that apply the same force in both directions. The circuit is fitted with a monoblock set-up unit including a pressure gauge, one nitrogen accumulators, an aligning valve and a calibrating circuit.

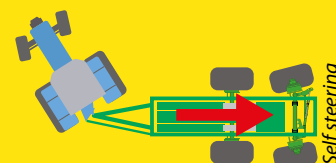

Steering axles
(100% self steering)

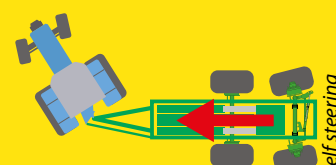



A professional's opinion

The family business Derks, located in the West of the Netherlands, is a loyal customer of JOSKIN. "We bought a JOSKIN Cargo-LIFT CLX hook-lift system of 6.80 m with Mitas 650/55R26.5 wheels that we are using for construction and silage works (maize and grass) as well as for the transport of grains. As strong points, we can mention its ease of use, its possibility to drive with a 200 HP tractor and its versatility. We are so happy with it that we're planning to buy new JOSKIN machines! Before this purchase, we were hesitating between a German brand and JOSKIN. But the JOSKIN model had more pump capacity and a higher speed of use. It was also easier to operate. Our good past experiences with JOSKIN, like the efficient and tested tyres remote inflating control, tipped the balance in JOSKIN's favour. Furthermore, the price was very competitive."





2 CARGO-LIFT RANGES:

CARGO-LIFT CL from 8 to 22 T
(6 MODELS: 5 DOUBLE-AXLE AND 1 TRIPLE-AXLE)

CARGO-LIFT CLX from 20 to 30 T
(6 MODELS: 3 DOUBLE-AXLE AND 3 TRIPLE-AXLE)

CL

From 8 to 22 T

Perfectly suitable compact and sturdy design. Hook-lift ideally integrated on an agricultural running gear.

D8-D12-D14

- Drawbar suspension with silent-blocks
- Hydraulic controls with direct connection to the tractor (3xDA):
 - container tipping;
 - telescopic arm;
 - container locking.
- Double-axle with parabolic leaves and wheel base of:
 - 1,160 mm on D8
 - 1,350 mm on D12
 - 1,550 mm on D14

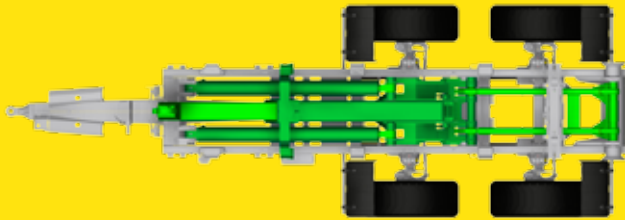

Hook-lift system

- Telescopic front beam system (except on D8: articulated model) including the **BOLTED** lifting hook in non-deforming steel (hook height: 1,450 mm, 1,430 mm or 1,570 mm)
- Hydraulic rams integrated into the chassis
- Standard hydraulic container locking from the inside to the outside
- Assisted tipping by hydraulic ram



Assisted tipping by hydraulic ram



SPECIFICATIONS

Management and control	Direct connection / alu control box with electro-hydraulic controls
Chassis	Tubular
Tipping stabilizer	Locking on Hydro-Tandem and Hydro-Tridem (option on 3rd point)
Hook	Telescopic front beam system (articulated on D8)
Brakes	Hydraulic and/or air brakes available, air brakes on T22
Required hydraulics	Standard: min. 180 bar with direct connection to the tractor As an option: 230 bar with pump

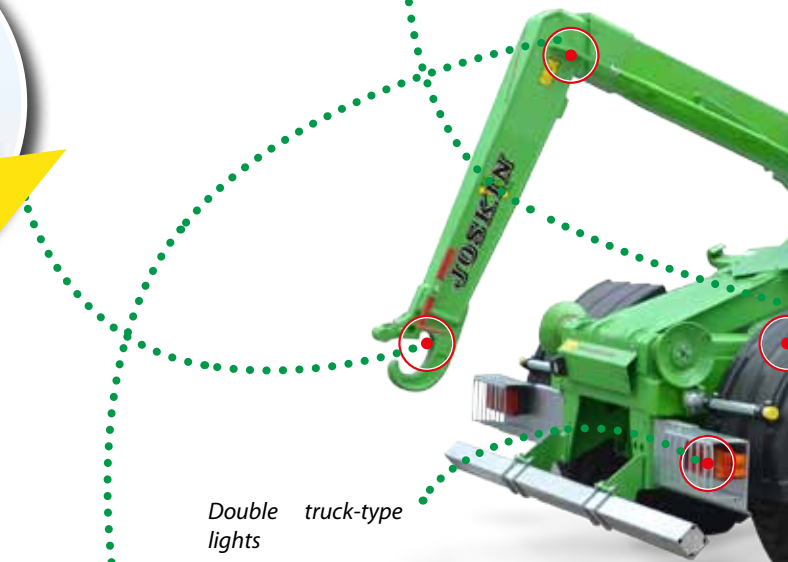

Double truck-type lights

Thermoplastic mudguards

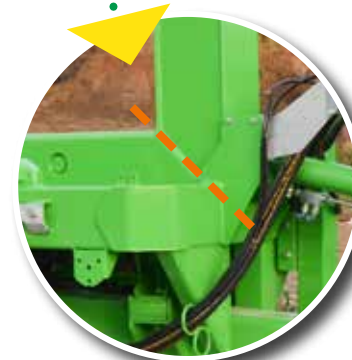

Design of the telescopic arm with diagonal welding and reinforcement, which makes it way stronger.

D18

- Hydropneumatic hitching suspension
- Double-axle with parabolic leaves and 1,550 mm wheel base
- Complete electro-hydraulic control of the machine (entry block, control of the container tipping, telescopic arm, container locking and drawbar with alu control box SA + FR)



T22

- Same as D22
- Double self-steering system (first and last axles) with hitching yoke, including quick coupling to the tractor and aligning set-up unit including: 2 nitrogen accumulators, oil tank, hand pump and pressure gauge
- Hydro-Tridem
- Air brakes
- Front lifting axle
- Complete electro-hydraulic control:
 - control of the container tipping;
 - telescopic arm;
 - container locking with alu control box (SA+FR);
 - hydropneumatic drawbar - front axle.

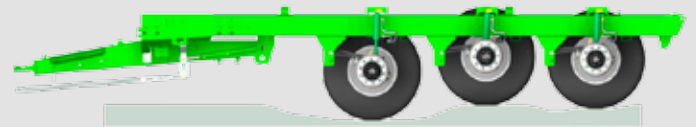

D22

- Same as D18
- Tipping stabilizer
- Hydro-Tandem

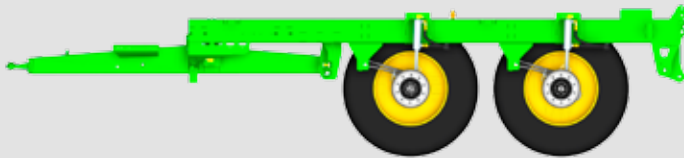

Drawbar

For optimal ergonomics of the machine, JOSKIN proposes the "arrow" type drawbar.

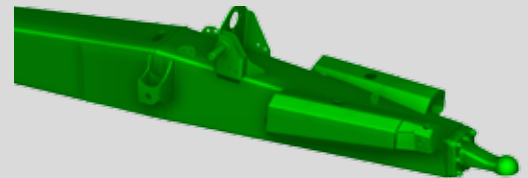

Hydropneumatic suspension D18-D22-T22

Mounted on a hydraulic ram with one or two nitrogen accumulators (loaded and unloaded positions), it offers an outstanding flexibility. The adjustable chassis slope allows to increase the wrenching force.



Hydraulic locking of the container



Shot-blasting before painting, Primer Ester Epoxy (2 K) and finishing lacquer.

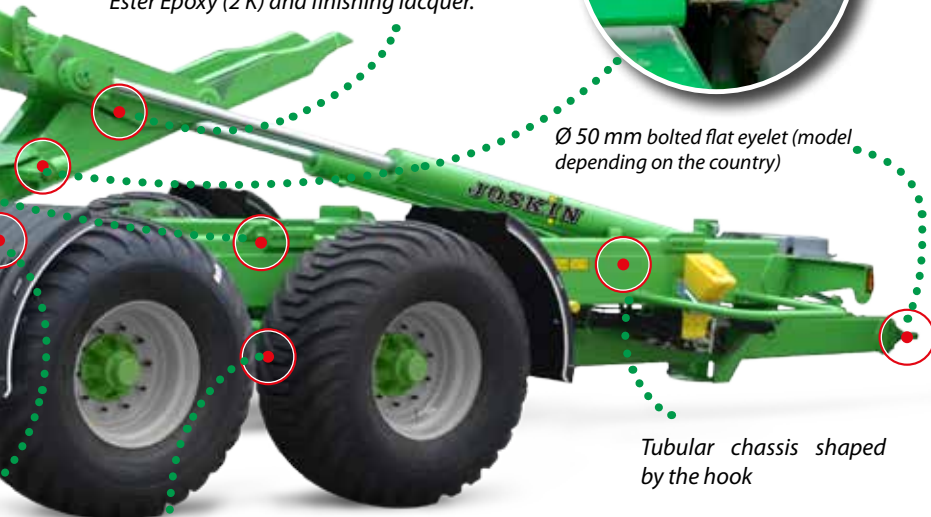

Ø 50 mm bolted flat eyelet (model depending on the country)

Tubular chassis shaped by the hook

Air and/or hydraulic brakes available



Silent-blocks D8-D12-D14

These rubber blocks ensure a smooth driving while keeping the traction line of the vehicle.



CLX

From 20 to 30 T

Designed for intensive professional use, this efficient implement offers power and reliability.

SPECIFICATIONS

Management and control	Alu control box with electro-hydraulic controls
Chassis	Tubular chassis with reinforcement in special DOMEX 690 steel - 8 mm
Tipping stabilizer	Locking on Hydro-Tandem/Hydro-Tridem
Hook	System with front telescopic beam
Brakes	Air brakes
Pump	140 l / 300 bar (standard: 3 high-flow electrovalves)

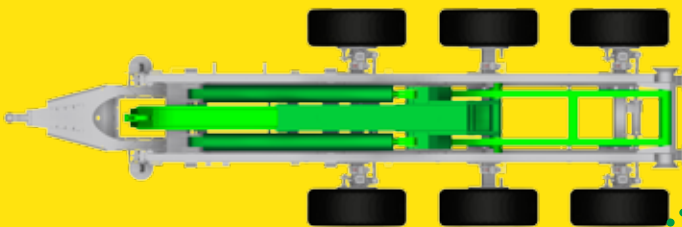

Hook-lift system

- System with front telescopic beam, including the **WELDED** lift-hook in non-deforming steel (height of welded hook: from 1,410 to 1,570 mm).
- Reinforced chassis in special Domex 690 steel of 8 mm thick on the whole length.
- Hydraulic rams integrated into the chassis.
- Standard hydraulic container locking from the inside to the outside.



VACU-CARGO LIFT

Currently, JOSKIN proposes slurry tanks that are adaptable to the Cargo-LIFT system.



VACU-CARGO LIFT MODELS

Possibilities according to chassis	5.5 m	5.9 m	6.4 m	6.6 m	6.8 m
Slurry tank	/	/	Vacu 16,000, 18,000, 20,000, 22,500 or 24,000 *		

* Sub-frame length: 6.8 m for 16,000 and 18,000 l, 7 m from 20,000 to 24,000 l. Smaller tanks are available on request.

D20

5500 - 5900 - 6400

- Hydro-Tandem: hydraulic axle suspension with 1,550 mm wheel base

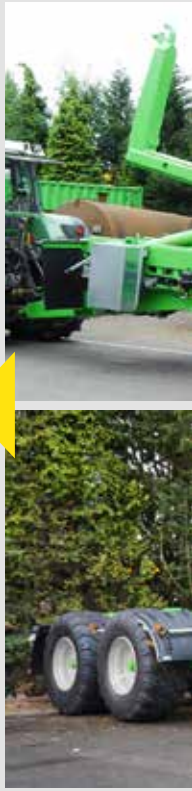
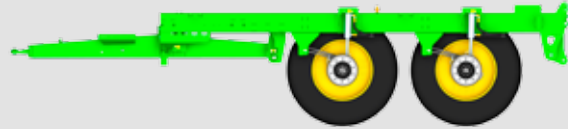

Cooling system

A radiator is installed near the hydraulic installation to cool down the oil.

Industrial hydraulic system

On the CLX models, the system is fed by an independent Load Sensing hydraulic pump of 140 l/min at 300 bar. The three functions of the hook are operated by means of 3 high-flow electrovalves.



Hydraulic pump



Hydraulic installation

Quick system

As an option, a fast unloading system with oil return to the opposite tank, when removing empty containers is available on the CLX model.



T30

6400 - 6600 - 6800

- Double self-steering system (first and last axles) with hitching yoke and aligning set-up unit including: 2 nitrogen accumulators, oil tank, hand pump and pressure gauge
- Front lifting axle
- Hydro-Tridem: hydraulic axle suspension (SA + FR) (25 cm clearance) with 1,550 mm wheel base and automatic height adjustment

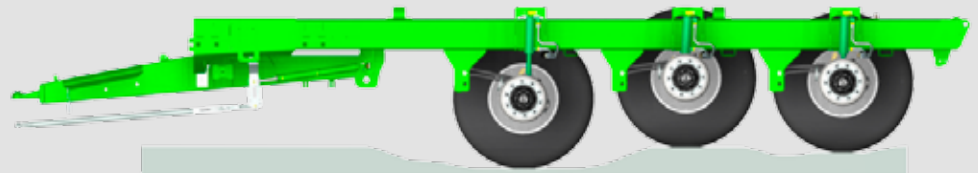

Hydraulic locking of the container

Shot-blasting before painting, Primer Ester Epoxy (2 K) and finishing lacquer

Wide angle P.T.O.-shaft with shear bolt

Double truck-type lights

Thermoplastic mudguards

Air brakes

Bolted eyelet (model depending on the country)

Hydraulic axle suspension



Drawbar

For optimal ergonomics of the machine, JOSKIN proposes a drawbar with hydropneumatic suspension.

Hydropneumatic hitching suspension

Mounted on a hydraulic ram with two nitrogen accumulators, it offers an outstanding flexibility.



CARGO-LIFT

Options

Suited to road and agricultural transport, this version of the hook system used on trucks meets contractors' need of ever more versatile transports.

The Cargo-LIFT allows to significantly increase the productivity of both staff and machines: thanks to its quick implement change, it is perfectly possible to remove the implement from the truck and lay it down on the side of the road before loading it on the CARGO-LIFT to use it on the fields. Then, it can be set on the truck again so that it can be transferred quickly to the destination, at the appropriate time, according to the driver's and vehicle's schedule.



Implements

Your Cargo-LIFT can be fitted with several implements, such as tanks or silage bodies.



Management and control

Compact and strong alu control box to operate the hydraulic functions of the machine.



NEW Dynamic weighing system

On model fitted with a hydraulic drawbar and suspension, a weighing system with wireless control box (sensors on the axle and drawbar suspensions) can be mounted as an option.

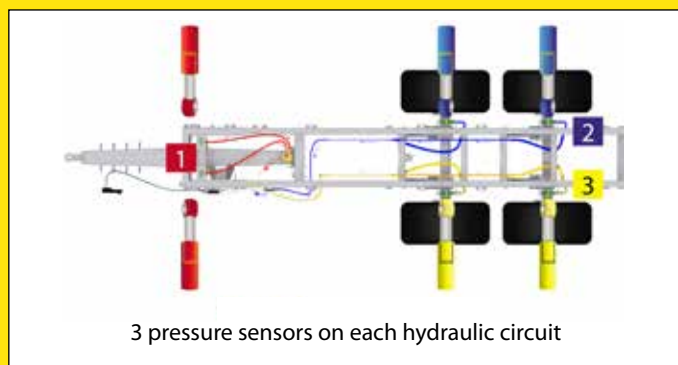

3 pressure sensors on each hydraulic circuit

Aluminium mudguards

Aluminium mudguards limit projections when driving.



Self steering axle(s)

The rear axle of the double-axle Cargo-LIFT can, as an option, be mounted as a free steering axle (with hydraulic locking above 15 km/h) or as a self steering axle in both driving directions. The triple-axle Cargo-LIFT are standard fitted with 2 self steering axles (front and rear axles).

Free steering axle (50% steering)

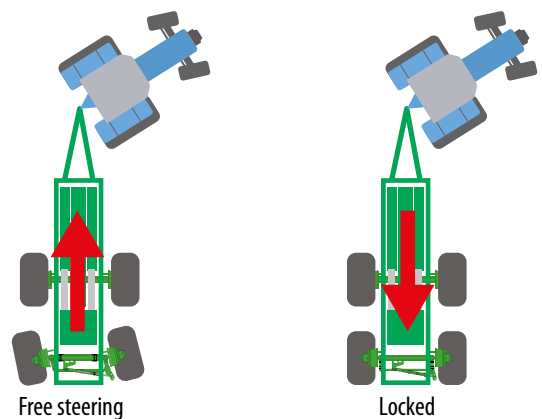

Self steering axle (100% steering)

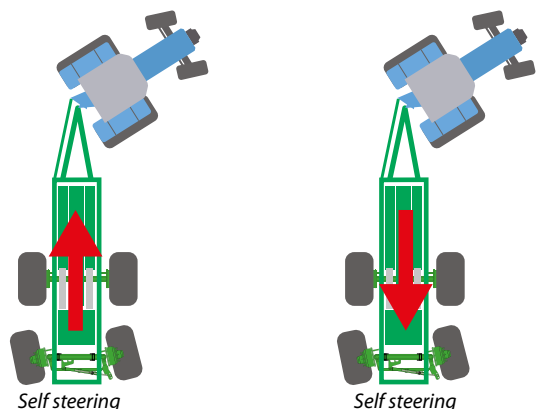

CARGO-LIFT

Tables and diagrams

Models	MIN./MAX. CONTAINER LENGTH (MM)				
	3,000 4,000	4,000 5,000	5,000 6,000	6,000 7,000	7,000 7,500
	NUMBER OF AXLES				
Cargo-LIFT CL	2	2	2/3		3
Cargo-LIFT CLX			2	2/3	3

The technically permissible payload is different from the wrenching force. It depends on many factors influencing the rear height of the chassis: the lower the height, the higher the wrenching force. For instance, the diameter of the tyres, the type of running gear suspension and the ground profile are elements influencing the system power. The type of hitching suspension (silent-blocks or hydro-pneumatic) also plays a certain role because the hydro-pneumatic suspension allows to tilt the chassis downwards.

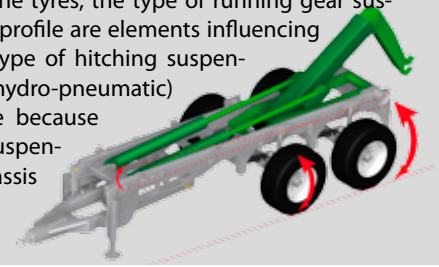

CL MODELS

	Min./Max. container length (mm)	Lifting angle	Max. wheel dimensions (mm) ⁽²⁾		Axle(s): □ (mm) - track (mm) - studs	Brakes (mm)	Stand
			∅	Width			
DOUBLE AXLE							
CL3600D8 ⁽¹⁾	3,000 - 4,200	41°	930	400	ADR 2x90x1900-8S	350 x 60	hydr. ⁽⁴⁾
CL4600D12 ⁽¹⁾	3,200 - 5,000	49°	1,140	500	ADR 2x100x2000-10S	350 x 60	hydr. ⁽⁴⁾
CL5000D14 ⁽¹⁾	4,200 - 5,500	47°	1,260	620	ADR 2x130x2100-10S	406 x 120	skid ⁽⁵⁾
CL5400D18 ⁽¹⁾	4,400 - 6,000	54°	1,260 ⁽³⁾	620 ⁽³⁾	ADR 2x130x2100-10S	406 x 120	skid ⁽⁵⁾
CL5800D22 ⁽¹⁾	4,700 - 6,500	55°	1,380	700	ADR 2x150x2100-10S	420 x 180	skid ⁽⁵⁾
CL6500D22 ⁽⁶⁾	5,700 - 7,500	54°	1,380	700	ADR 2x150x2100-10S	420 x 180	skid ⁽⁵⁾
TRIPLE AXLE							
CL6500T22 ⁽¹⁾	5,700 - 7,500	54°	1,380	700	ADR 3x130x2100-10S	406 x 120	skid ⁽⁵⁾

⁽¹⁾The first 2 letters indicate the Cargo-LIFT CL range, the 4 numbers the length of the "LIFT" chassis (in mm), the letter indicates the number of axles and the last two numbers the technically permissible payload (in t). ⁽²⁾Dimensions for a standard machine without steering axle (except if the steering axle is part of the standard equipment of the machine). ⁽³⁾With hydraulic suspension (ref. 3180): max. wheel ∅ of 1,350 mm and max. width of 700 mm. ⁽⁴⁾Hydraulic stand with direct connection. ⁽⁵⁾Hydraulic skid with direct connection to the tractor (DA). ⁽⁶⁾The rear axle will be set in its rearmost position in order to ensure a sufficient support when loading the container. In order to avoid a too big load on the eyelet in transport position, the maximum permissible total load will be limited - for further information, please contact your representative.

	CL3600D8	CL4600D12	CL5000D14	CL5400D18	CL5800D22	CL6500D22	CL6500T22
A	3,780 mm	3,335 mm	3,847 mm	4,074 mm	4,273 mm	5,063 mm	5,063 mm
B	/	1,020 mm	1,020 mm	1,140 mm	1,300 mm	1,300 mm	1,300 mm
C	400 mm	864 mm	916 mm	1,109 mm	904 mm	568 mm	904 mm
D	3,900 mm	4,800 mm	5,300 mm	5,580 mm	5,780 mm	6,545 mm	6,577 mm
E	1,577 mm	1,670 mm	1,870 mm	1,873 mm	2,073 mm	2,662 mm	2,073 mm

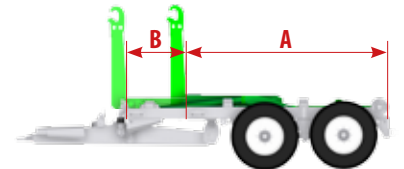
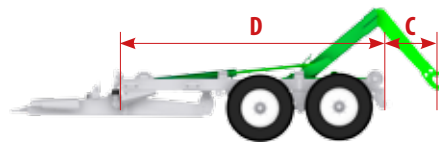
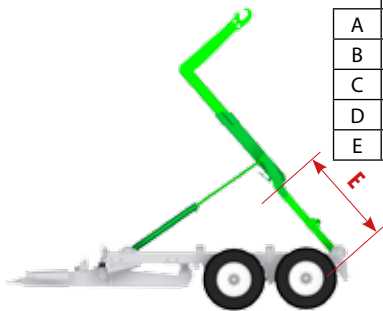

CLX MODELS

	Min./Max. container length (mm)	Lifting angle	Max. wheel dimensions (mm) ⁽²⁾		Axle(s): □ (mm) - track (mm) - studs	Brakes (mm)	Stand
			∅	Width			
DOUBLE AXLE							
CLX5500D20 ⁽¹⁾	4,000 - 6,200	55°	1,500	750 ⁽³⁾	ADR 2x150x2100-10S	420 x 180	skid ⁽⁵⁾
CLX5900D20 ⁽¹⁾	4,400 - 6,600	49°	1,500	750 ⁽³⁾	ADR 2x150x2100-10S	420 x 180	skid ⁽⁵⁾
CLX6400D20 ⁽¹⁾	4,900 - 7,100	49°	1,500	750 ⁽³⁾	ADR 2x150x2100-10S	420 x 180	skid ⁽⁵⁾
TRIPLE AXLE							
CLX6400T30 ⁽¹⁾	4,900 - 7,100	51°	1,400	720	ADR 3x150x2100-10S	420 x 180	hydr. ⁽⁴⁾
CLX6600T30 ⁽¹⁾	5,100 - 7,300	48°	1,400	720	ADR 3x150x2100-10S	420 x 180	hydr. ⁽⁴⁾
CLX6800T30 ⁽¹⁾	5,300 - 7,500	47°	1,400	720	ADR 3x150x2100-10S	420 x 180	hydr. ⁽⁴⁾

⁽¹⁾The first 2 letters indicate the Cargo-LIFT CLX range, the 4 numbers the length of the "LIFT" chassis (in mm), the letter indicates the number of axles and the last two numbers the technically permissible payload (in t). ⁽²⁾Dimensions for a standard machine without steering axle (except if the steering axle is part of the standard equipment of the machine). ⁽³⁾With steering axle, the max. width is 720 mm. ⁽⁴⁾Double hydraulic stand with direct connection to the tractor (DA). ⁽⁵⁾Hydraulic skid with direct connection to the tractor (DA).

	CLX5500D20	CLX5900D20	CLX6400D20	CLX6400T30	CLX6600T30	CLX6800T30
A	3,972 mm	4,372 mm	4,622 mm	4,622 mm	5,150 mm	5,150 mm
B	1,200 mm	1,200 mm	1,450 mm	1,450 mm	1,450 mm	1,650 mm
C	1,252 mm	852 mm	1,081 mm	1,081 mm	858 mm	1,269 mm
D	5,500 mm	5,900 mm	6,400 mm	6,400 mm	6,600 mm	6,800 mm
E	1,600 mm	2,000 mm	2,000 mm	2,000 mm	2,300 mm	2,100 mm

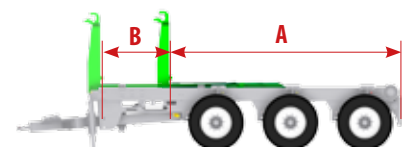
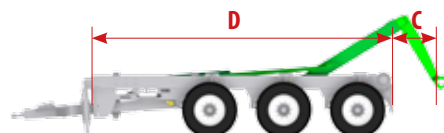
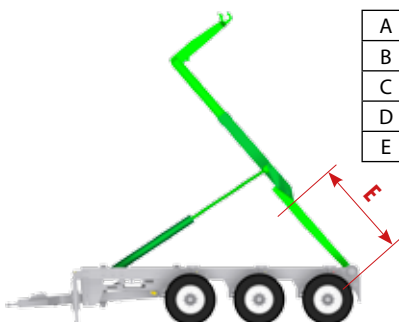

Non contractual data.

JOSKIN



Non-contractual document. Data are subject to change without notice. The pictures do not necessarily correspond to standard equipment.

www.joskin.com

rue de Wergifosse, 39 • B-4630 Soumagne - BELGIUM • E-mail: info@joskin.com • Tel.: +32 (0) 43 77 35 45



Your local JOSKIN partner

