

Unchained

The Chainless balefeeder range



HUSTLER[®]

No chain, no pain

FIVE REASONS TO CHOOSE A CHAINLESS

- 01: No feed chains = extremely low maintenance.**
Less wear, longer life and low power requirement due to superior Hustler engineering.
- 02: Will easily feed out round or square bales, any size.** The Chainless can handle any type of bale that you have on hand - balage, hay, straw, lucerne etc.
- 03: Bales are teased apart by variable rotors.**
The Chainless lays down a fluffed-up windrow which stock can easily eat, reducing trampled and wasted feed.
- 04: Proven farmer-friendly bale loading systems.**
We have set the bench mark for others to follow. When we say total control we mean it.
- 05: 2 year warranty.**
Hustler's stamp of quality, backed up by more than 200 accredited dealers nationwide.



"It's a brilliant machine! The loading system is outstanding, able to control the bale right through its action. Such a safe loading system - it holds the bale just above the platform, allowing you to take the net wrap off before completing loading.

You don't need a big tractor to operate it, it only requires a reasonable oil flow. So simple to operate. I'm rapt with it. It's a Rolls Royce!" **DAIRY FARMER, TAHUNA, WAIKATO: CHAINLESS 4000**

Heart of the beast

INSIDE THE HUSTLER CHAINLESS SYSTEM

2
YEAR
WARRANTY

PADDLES

Paddles on lower drum help when feeding out very sloppy bales.

VARIABLE FEED

Infinitely variable rotor speed via the tractor's hydraulics adjusts the rate of feed. Choose thick for cows or thin for sheep by adjusting rotor speed accordingly.

FEED TEASERS

Top rotor spins at three times the speed of the bottom rotor, teasing and separating the feed rather than simply unrolling it. This makes the feed much easier for stock to eat resulting in less wasted feed, especially in muddy conditions.

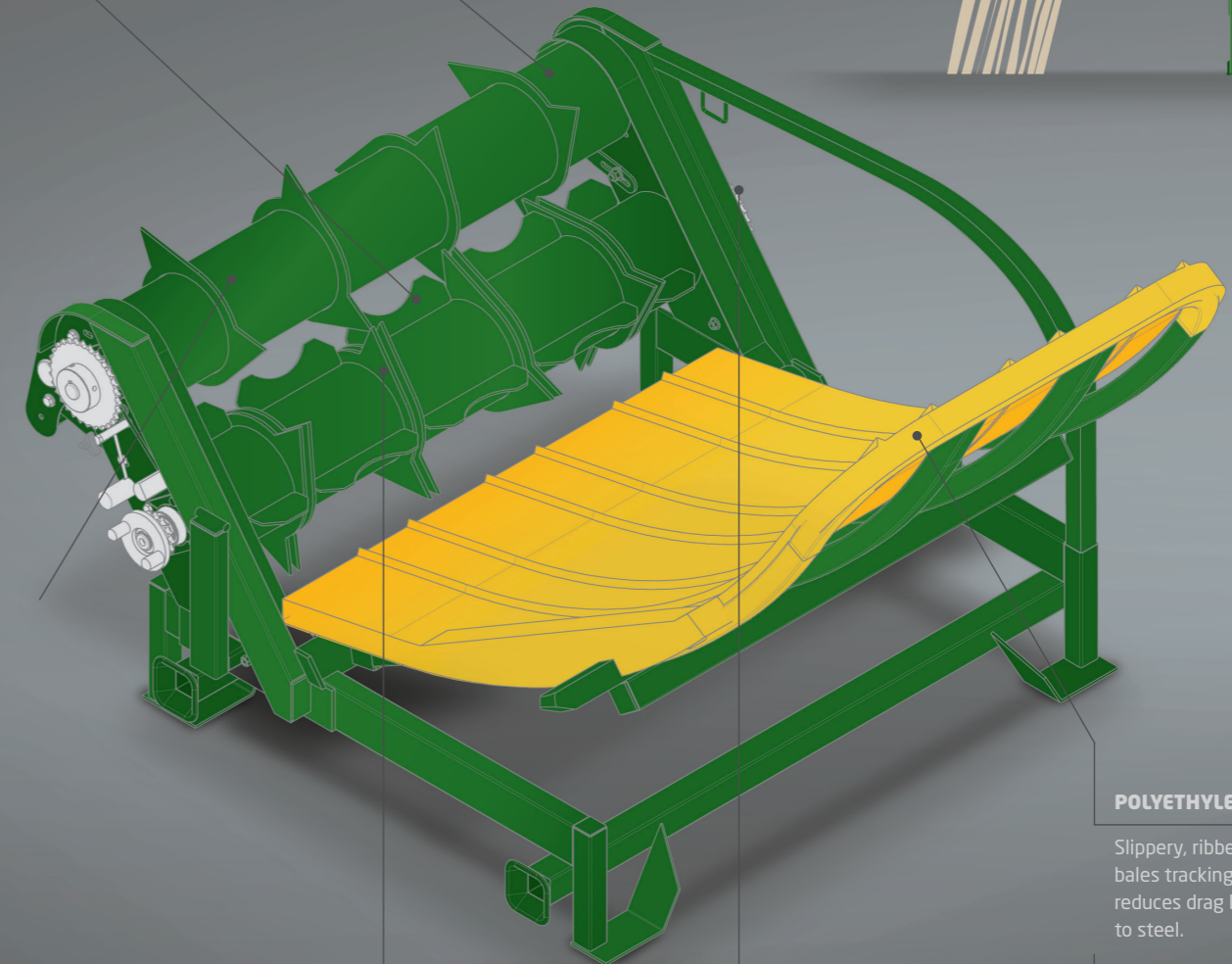

WIPER PANEL

Free-flow wiper panel cleans the top rotor. The updated design clears even the longest hay.

NO FEED CHAINS

Chains are the most troublesome part of conventional feeders. No chains means no trouble and very low maintenance.

SELF CLEANING

Rotors are timed together to self-clean and carry the feed up over the edge.

PLATFORM HEIGHT GUIDE

Built-in platform height guide provides an indication of platform height for either squares or rounds. Operators lift the platform height to the relevant indicator then adjust the platform to allow for bale density.

POLYETHYLENE PLATFORM

Slippery, ribbed design keeps bales tracking straight and reduces drag by 30% compared to steel.

FEED CONTROL

Infinitely variable platform height controls pressure of the bale on the rotors. Even the tightest of bales can be fed out correctly with a Chainless because the operator can vary platform pressure to allow for bale density.

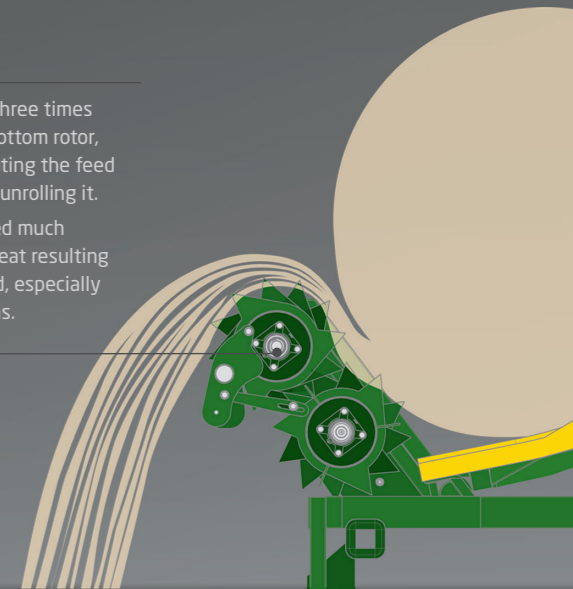

Chainless 2000

SINGLE BALE FEEDER SERIES 3

This is a 3-point-linkage Chainless bale feeder suitable for any type of round and square bales. Ideal for smaller farms, while still having the capability to handle the biggest of bales and fastest of tractors.



New stronger rear fence holds the bale more securely in steep country.

Transmission covers protect against mud and debris and seal the heavy-duty 4-bolt bearings.

Slippery, ribbed design keeps bales tracking straight and reduces drag plus will never corrode.

Free-flow wiper panel has more adjustment for a wider range of balage types.

High-mounted hook latch for exceptionally secure drive alignment.

Light weight at just 490 kgs.

Ultra-low cradle for loading.

Safety latch ensures platform is down before cradle can be disconnected.

Platform height guide shows start position for round and square bales.

Our floating toplink pin and unequal length tines make reconnecting easy.

CHAINLESS 2000 LOADING SEQUENCE

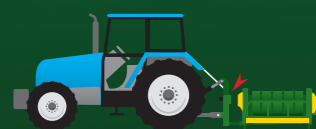

01 Disengage cradle



02 Back in to pick up bale

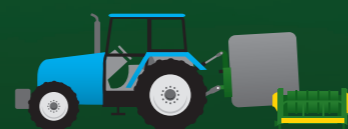

03 Load bale onto cradle

THE CHAINLESS SYSTEM

Chains have traditionally been the weak point of balefeeders, requiring a lot of maintenance and usually being the first thing to break.

So we eliminated them. Fifteen years later the Chainless system has been proven by thousands of hours of breakdown-free operation.

1 CLEAT DESIGN

Provides a more positive grip on the bale when feeding out fine or sloppy bales.

2 STRONGER DRIVE SYSTEM

We've increased the key size to provide a more positive and heavy-duty drive train capable of heavier and sloppier bales.

3 FREE-FLOW WIPER PANEL

With wider adjustment range and less fine tuning required, you can easily customise feed to your preference.

4 SLIPPERY POLYETHYLENE RIBBED FLOOR

Slippery, ribbed design keeps bales tracking straight and reduces drag by 30% compared to steel.

INFINITELY VARIABLE FEED PATTERN

Only rotor speed needs adjusting to vary the amount of feed being fed out. The fully adjustable platform height allows you to vary the bale pressure, so no matter how tight or loose your bale, the Chainless can still feed it out.

QUIET OPERATION

Exceptionally quiet operation means your stock are more relaxed at feeding time.



OPTIONAL EXTRAS

MUDGUARDS

Keep your feed clean and dry in-transit. On the Series 5 you can add mudguards later as a bolt-on kit.

60 LITRE STRINGBOX

Available as a bolt-on kit that can be fitted to any Chainless 4000. Very handy for stowing that bale wrap while you're out and about.

THIRD TINE

A third loading tine is available to support wider 8' bales during transport and loading.

EXTENSION

An extension bar extends the platform for extra support for 8' bales. Now optional as 8' bales are less common.

2
YEAR
WARRANTY

Chainless 4000

TRAILED TWO BALE FEEDER, SERIES 5

Designed for medium to large operations feeding out thousands of round or square bales each year, the Chainless 4000 has proved its worth over many years.

The Series 5 Chainless has been fine tuned to make it even stronger and easier to use. A Hustler classic, built tough to go the distance.



WHEEL/ MUDGUARD OPTIONS

10/75-R15.3 implement wheels are standard. Optional 10/75-R15.3 traction tyres and 13/55-R17 flotation tyres are available. Optional mudguards keep the feed clean and dry in-transit.

WEIGHT

At just 990kgs, our impressive strength to weight ratio has been achieved by using higher tensile steel. We've done our homework and put the steel where it's needed, not in case it's needed.

CHASSIS DESIGN

Tweaked for Series 5 and tougher than anything else out there, our chassis has massive ground clearance. We've added a guard plate so there's nothing to tear or catch on obstacles. Plus our 6-stud axles are the strongest on the balefeeder market.

TOTAL CONTROL LOADING INDICATOR

The loading indicator makes loading any bale simple: line up the indicator to correct bale position, back in and load.

DRAWBAR

Our single post drawbar design has set the benchmark in feeder manoeuvrability. The drawbar is completely removable and is now fitted with built-in road-legal safety chain mounts.

PARKING JACK

Designed to make parking quicker, our new heavy-duty parking jack has an oversized mounting boss and more positive lock. To allow for tighter turning, we've added an extra mount on top of the drawbar for stowing the jack.

SLIPPERY FLOOR

Slippery, ribbed design keeps bales tracking straight and reduces drag plus polyethylene will never corrode.

LOOK SHARP

New sandblasted finish and improved paint system means your new Chainless will look smarter for longer.

DIVERTOR VALVE

Our divertor valve is a safety feature and means the 4000 is ideal for tractors with only 2 double acting remotes.

TOWING EYE

The newly designed 12,000kg towing eye has 50mm height adjustment, enabling the Chainless 4000 to stay level behind virtually any tractor. It rotates 360°, making feeding out on uneven terrain trouble-free.

CHAINLESS 4000
LOADING SEQUENCE

Handle it

TOTAL CONTROL LOADING SERIES 2



01 Back tines into bale

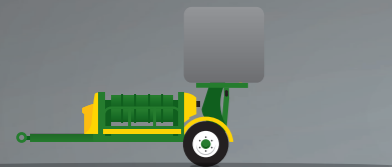

02 Bale is always under control



03 Remove net wrap



04 Tines withdraw



05 Tines ready to pick up 2nd bale



06 Bales in transport position



Hustler's unique Total Control Loading (TCL) system has revolutionized bale loading since it was introduced eight years ago. TCL Series 2 has a faster cycle, bigger bale handling, quieter operation and foolproof resetting.

With just one hydraulic cylinder, TCL is the fastest loading system out there. One cylinder also means it's less demanding on your tractor's hydraulics and we've added a new gas strut to help reset the loader.

Our Total Control Loading System provides exactly what it says: total control. Unlike any other system, the operator can reverse the bale if necessary, even once the bale is positioned low over the cradle for unwrapping.

THE TOTAL CONTROL LOADING ADVANTAGE:

- Easy bale pickup means no digging up of paddocks or dirt mixing with feed
- Bale is easy to line up
- Minimal feed wastage because the net wrap can be removed above the bale chamber
- Gentle and accurate placement of the bale in the bale chamber
- Bale is secure during transport, even on steep inclines
- Handles round and square bales
- Second bale can be positioned low to the ground for added ballast

REFINEMENTS INCLUDE:

- Stronger boom with added gussets: carry and load heavier bales
- Increased bearing surface on boom pivots for longer service intervals
- Stronger tine frame for bigger bales
- Stronger topline design to carry heavier bales
- New gas return strut makes operation faster and more positive

Chainless 8000

FOUR BALE BALEFEEDER

Designed for larger operations, our trailed Chainless 8000 model carries up to four round or square bales ready to be fed out. Built around the proven Chainless feeding chamber, the 8000 will feed out any round or square bale you have on hand.

Requiring only 2 double-acting remotes to operate all four functions, it can be operated easily on older tractors with few hydraulic functions.



Heavy duty steel tail door is powered by a hydraulic ram meaning less maintenance.

Tail door slides on 4 low-friction UHMW wear blocks which extend service intervals and don't require lubrication.

Slippery extruded polyethylene floor makes moving sticky silage or wet bales into the feeding chamber easy.

Quick connecting and disconnecting: heavy-duty parking jack plus ball valves on the hydraulic hoses which allow disconnection with hoses under pressure.

Stabiliser foot has a serrated edge to dig into the ground when pushing bales up from the rear.



Tandem oscillating axles carry the extra load with ease and provide suspension.

Excellent side reach means the Chainless 8000 is capable of feeding into troughs or feed pads. The optional adjustable side extension allows for 8' square bales.

Auto bale separator: each bale is pushed into the feeding chamber by the hydraulically operated tailboard. The feeding chamber then automatically separates the bales by 200mm making feeding out easier with less friction.

Heavy-duty forged towing eye and built-in safety chains.

CHAINLESS 8000 LOADING SEQUENCE



01 Drop stabiliser foot and unhitch tractor

02 Load and push bales up the bed with front-end loader (can also be loaded from the side)

03 Four bales loaded and feedbed raised ready to feed out

HUSTLER INNOVATION

Hustler has been building strong, reliable balefeeders for Australasia for more than 20 years.

At Hustler, we develop our equipment based on input from the people who use our machines. It's our practical innovations and our ability to meet changing demands that gives Hustler the edge.

Our commitment to research and development means we build equipment you can consistently rely on, year in year out, ensuring you exceptional value for money.

Hustler technology: We have adopted LEAN manufacturing techniques, robotic welding, laser and plasma cutting technology and CNC-controlled equipment to ensure the very best quality, consistency and efficiency.

The introduction of sandblasting equipment and a wet-sprayed, 2-coat system means your Hustler has the best possible finish.

Hustler heritage: When you invest in Hustler products you are investing in forty years of research and development, backed up by Hustler's extensive nationwide network of accredited dealers.



Our dealer network guarantees technical backup and quick replacement of parts.

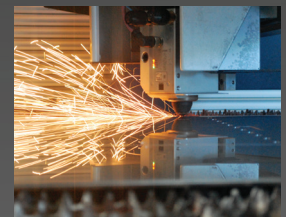
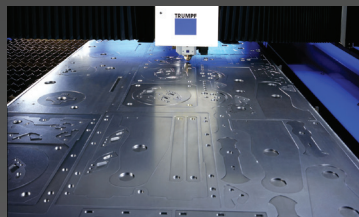

CHAINLESS 8000 TRAILED 4-BALE FEEDER



CHAINLESS 4000 TRAILED 2-BALE FEEDER



CHAINLESS 2000 LINKAGE FEEDER



SL700X TRAILED 2-BALE FEEDER



SL350 LINKAGE FEEDER



SL450X LINKAGE TROUGH FEEDER



sales@hustlerequipment.co.nz

NORTHERN 07 847 6923

CENTRAL 06 873 9154

SOUTHERN 03 434 0412

www.hustlerequipment.co.nz

