

# FENDT

## Fendt 700 Vario





## Fendt 700 Vario – the perfectionist.

It's the cornerstone behind every Fendt innovation: take something great and make it better. It's no coincidence that the Fendt 700 Vario has been one of the most popular tractor series for years. Its combination of strength, agility, functionality and comfort make it a reliable partner. Now the operating philosophy FendtONE, consisting of a new driver's workstation and the FendtONE platform, sets even higher standards.



Perfected for every kind of work.

This versatile tractor, ranging from 144-237 hp, is your perfect partner for all kinds of work – from easy-going grassland work, to dynamic transport, to heavy-duty field or fleet operations.

Engine		714 Vario	716 Vario	718 Vario	720 Vario	722 Vario	724 Vario
Rated power ECE R 120	kW/hp	106/144	120/163	133/181	148/201	163/222	174/237

**Turn your work routine into perfection.**

The new 700 Vario has it all – strength, agility, precision, reliability, functionality and comfort.

- Power segment 144 to 237 hp
- Self-levelling front axle suspension
- Front power lift with load-relief control
- 3. front loader valve enabling three functions to be used simultaneously
- TMS pedal mode that adjusts deceleration by detecting thrust
- Automatic trailer steering axle lock
- 100% differential locks for front and rear
- Increased lift capacity of 10,360 daN
- 14 t permissible overall weight
- High payload of up to 6,200 kg
- Load-sensing pump with 109 l/min as standard, and an optional 152 l/min or 193 l/min.
- 4-speed rear PTO
- 1000E economy PTO
- ISOBUS socket in the front and rear



**Making the best even better.**

The new driver's workstation is the ultimate space for more functionality, customising and ergonomics.

- New armrest with familiar Fendt elements
- Incorporates up to 3 display options:
  - Digital dashboard
  - 12" terminal on the armrest
  - Additional terminal retracts into the roof liner
- Customise your terminals
- New multifunction joystick with even more functions
- Flexible key assignment with Individual Operation Manager (IOM)
- Logical colour coding
- Infotainment package
- Premium sound system
- New end-to-end operating philosophy FendtONE
- 4 USB ports on the armrest

Become a perfectionist.  
With the Fendt 700 Vario.

ENGINE AND GEARBOX

# For the ultimate drive.

**Power and reliability**

The tried and proven 6-cylinder Deutz engine on the Fendt 700 Vario delivers 144 to 237 hp with a top speed of 50 km/h. With a 6.1 litre cubic capacity, 4 valves per cylinder and common rail injections, this engine delivers a high-torque driving experience. The compact high-horsepower tractor is designed for maximum performance and load capacity. The engine and transmission are perfectly in tune for high overall efficiency.

**Stepless driving with the proven Vario gearbox**

The Vario gearbox provides a stepless drive from 0.02 km/h to a maximum speed of 50 km/h. The continuously variable speed adjustment optimises engine use. The Tractor Management System (TMS) also makes it particularly fuel-efficient. TMS controls the engine and transmission so that they are always working at their economical best. You just have to set the speed.

**Automatic maximum load control 2.0**

Features like the automatic maximum output control 2.0 further reduce fuel consumption, with the engine always running in the ideal speed range. The maximum load control sets how far the engine speed is allowed to drop under load before the transmission shifts. It adjusts according to the engine load – or to the target speed if TMS or cruise control is on.

**Good reasons to drive Vario**

- Highly fuel-efficient by auto-adjusting the transmission and engine (TMS) according to load
- Automated controls with cruise control function and maximum load control 2.0
- Stepless, jerk-free start-up
- Fully wear-free switching from forwards to reverse drive as the hydro pump swivels
- Gear oil change only required every 2,000 operating hours
- Prevents oil contamination due to separate transmission and hydraulic oil supplies
- And much more



Exhaust stage V is met thanks to the external exhaust gas recirculation, SCR technology and diesel particulate filters. The external exhaust gas recirculation reduces the nitrogen oxides (NO<sub>x</sub>) even before reaching the exhaust pipe, so that AdBlue is used particularly sparingly.



The Fendt Vario transmission is a hydrostatic-mechanical power split drive. With increasing speed, the share of the mechanical power transmitted through the planetary set increases. The hydrostats can be moved 45° and have a high operating pressure of max. 550 bar – this ensures exceptional efficiency.

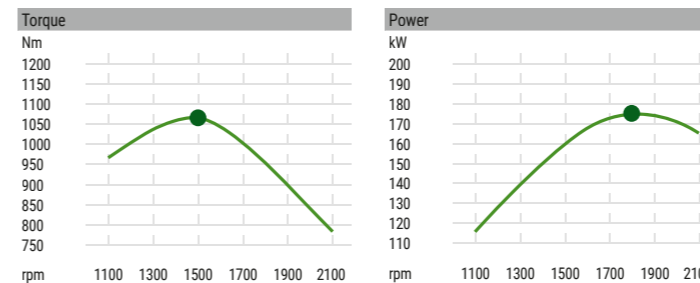

The high-end model – the Fendt 724 Vario – reaches its maximum torque of 1,072 Nm at just 1,500 rpm.

PTO, POWER LIFT AND HYDRAULICS

# Flexible for every kind of work.

**PTO: performance when you need it**

The following PTO speeds are available with the Fendt 700 Vario:

- Rear PTO shaft: 540/540E/1000/1000E
- Optional front PTO: 1000

The efficiency is particularly high due to the almost direct through-drive from the crankshaft to the PTO stub. The overload protection also prevents the engine from suddenly stalling with extreme impact loads on the PTO shaft.

**Powerful at the front and rear**

With a lifting capacity of 10,360 daN, the rear power lift of the Fendt 700 Vario is ideally equipped for a range of applications. The active shock load stabilising system promises the best driving comfort even with heavy attachments. Various configurations are available at the front: from a comfort ballast holder to the comfort power lift with double-acting cylinders, position control and load relief. With load relief, you can work with your implements for longer. A position sensor also detects bumps in the ground.

**Hydraulics for every job**

Depending on the configuration, the Fendt 700 Vario offers a standard load-sensing pump with a flow capacity of 109, 152 or 193 l/min. At 64 litres, it provides a high volume of extractable oil to supply large consumers. The Fendt 700 Vario has a hydraulic oil preheating function to get the hydraulic system up to full capacity faster even in cold weather. Gearbox and hydraulic oil have their own tanks to prevent mixing. Up to 4 double-acting valves are available in the Power and Power+ configurations. Profi and Profi+ have max. 5 double-acting valves at the rear and max. 2 double-acting valves in the front. The flow rate of up to 100 l/min can be individually adjusted in the terminal for each valve. The hydraulic valves on both sides can be coupled under pressure via the DCUP and CUP couplings.

**Front power lift with load-relief control**

With this intuitive power lift with position and load relief control, you can transfer some of the implement weight to the front axle. Fine-tune the degree of load relief with a special double-acting front power lift valve. This ensures both the safe steering of the tractor and that the front-mounted implement only applies the pressure it needs for the work it is doing.



**Automatic steering axle lock**

The optional automatic steering axle lock automatically unlocks the self-steering axle on trailers within a set speed range. On straight stretches, the rigid self-steering axle ensures stable handling. Operators do not need to lock the self-steering axle manually outside of the preselected speed range and when reversing.

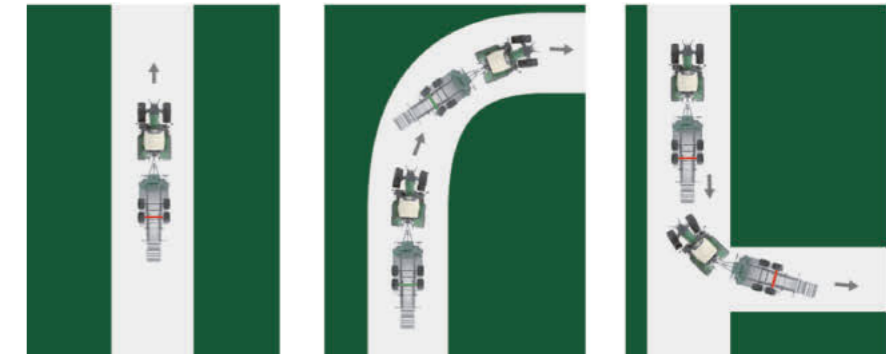

**External controls**

Using the double-sided fender controls, you can actuate the PTO, the rear hitch and a control unit of your choice in the tractor boot.

FENDT CARGO FRONT LOADER

# Unbeatable in combination.

### Perfectly in tune

Put your Fendt 700 Vario to work with the Fendt Cargo front loader and you have the perfect team. The VisioPlus cab and the slim, low hood promise the ultimate, unobstructed view of 77°. The windscreen on the cab curves up into the roof for an unobstructed view over the raised front loader. The integrated curvature also means any material just slides off.

The Cargo features Z-kinematics for the best parallel guidance. This keeps implements in the same position over the entire lifting height. Since the designs of the front loader and tractor have been specially adapted to each other, all maintenance work can be performed while the front loader is mounted.

### Fully integrated operating concept

The Fendt Cargo controls are perfectly integrated into the Fendt 700 Vario. Depending on the configuration, you can choose between a crossgate lever or the 3L joystick as the controller for the front loader. There is now a reverse drive button on the new 3L joystick, so you no longer have to reach over to change direction.

### 3L joystick: Front loader work has never been so easy

With the 3L joystick, you have all front loader functions in one place. The reverse drive button is right there, so no reaching over to other control panels. Together with a Fendt front loader that has a third valve, you can control an unprecedented 3 functions at once.



### 3. Front loader valve for more options

With the third valve for Fendt Cargo front loaders, you can run up to 3 functions at the same time. This helps when using a round baler fork lift, for example. Lower the front loader, extend the bale forks and open them at the same time.

### Precision loading with the CargoProfi\*

The CargoProfi offers you added functions. Work with a variety of settings with the help of special measuring and tilt sensors as well as a job calculator. The CargoProfi features include a weighing function that can be used to record loads as a unit or total weight. You can read the data in the terminal or show it in your own view on the dash. There is also a vibrating function to shake off all the solid material from the bucket. And for loose material, losses caused by trickling are minimised through the end position damping. Lifting height and tilt angle can be limited by the driver and saved as programmed positions.

\*available for front loader models 5X/85 and 5X/90. Available from early 2021

### VarioActive superimposed steering system

Faster steering with the VarioActive steering system: Just one turn of the steering wheel reaches a full steering angle. VarioActive is a real bonus in comfort, especially for front loader work, but also on headlands and in compact yards.



### Front loader with damping system

Gas pressure reservoirs act as shock absorbers and prevent vibrations from being transmitted to the tractor body. The built-in damping system, together with front axle and cab suspension, offer superior driving comfort.

### Front loader without damping system

Shock loads are transmitted to the tractor.

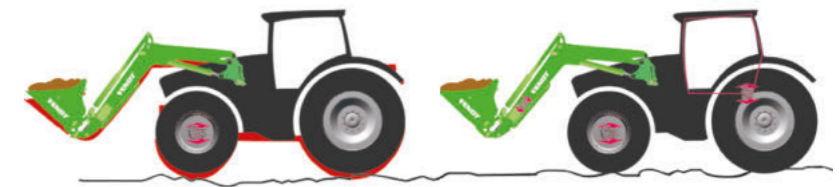

The curved windscreen of the VisioPlus cab offers a 77° viewing angle.

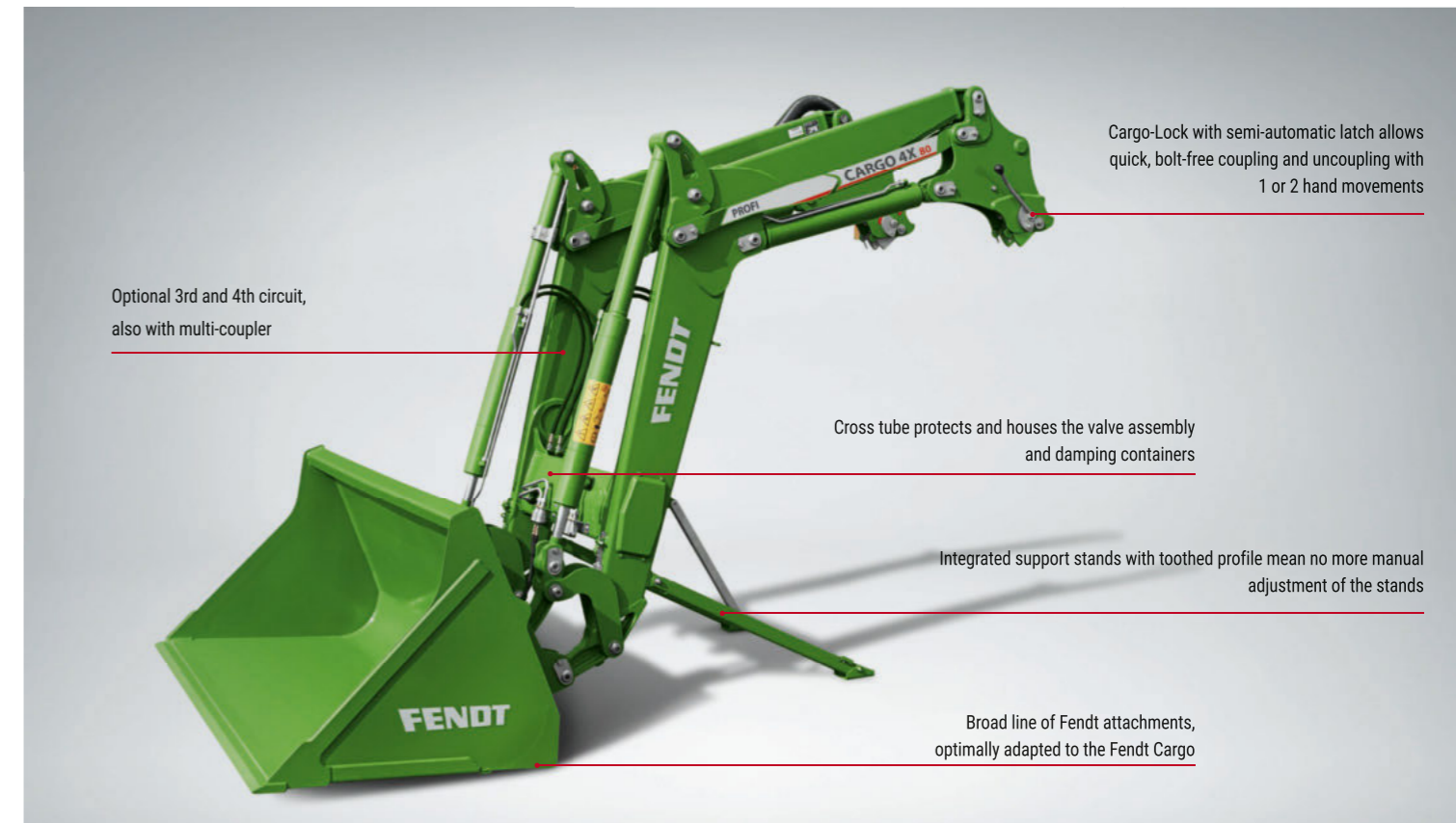

Cargo-Lock with semi-automatic latch allows quick, bolt-free coupling and uncoupling with 1 or 2 hand movements

Optional 3rd and 4th circuit, also with multi-coupler

Cross tube protects and houses the valve assembly and damping containers

Integrated support stands with toothed profile mean no more manual adjustment of the stands

Broad line of Fendt attachments, optimally adapted to the Fendt Cargo

Fendt Cargo front loader		4X/85 <sup>2</sup>	5X/85 <sup>1</sup>	5X/90 <sup>1</sup>
<b>A</b>	Digging depth (tyre-dependent)	mm	130	250
<b>B</b>	Excavation height (tyre-dependent)	mm	4150	4460
<b>C</b>	Laying width at height of 3.5 m (tyre-dependent)	mm	1610	1910
<b>C</b>	Laying width (tyre-dependent)	mm	980	1080
<b>D</b>	Dumping angle	degrees	55	55
<b>E</b>	Rollback angle	degrees	48	48
	Continuous lifting capacity	daN	2600	2950
	Max. lift capacity	daN	3000	3460

<sup>1</sup> Same values apply to Fendt CargoProfi  
<sup>2</sup> Fendt 700 Vario (up to max. tyre Ø 1450 mm)

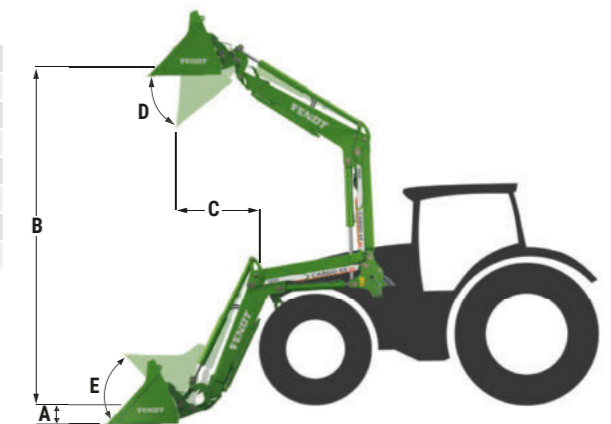

## CAB WITH FENDTONE DRIVER'S WORKSTATION

# A workplace that feels like home.



### Retractable roof terminal

The 12" roof terminal retracts half way into the roof liner. Applications like the air conditioning or the Infotainment system are still shown on the lower, visible half of the terminal.

### Take something great and make it better

The new FendtONE driver's workstation is marked for its functionality, customising options and ergonomics, without losing any of the control you expect from Fendt.

### More control options

- New ergonomic multifunction joystick – more buttons ready to be assigned (including ISOBUS)
- Buttons ready to be assigned on the armrest
- No extra controls required (external terminals, joysticks)

### Simple operation

- All your controls are in one place – no need to reach between the cockpit, armrest and roof liner.
- Flat menu structure in the terminal so you can easily find features
- The various function groups are colour-coded, e.g. orange for the drivetrain or gear functions, blue for hydraulics and power lifting functions, etc.

### Controls are customisable

You have the option to freely assign functions to specific controls. Never before has the workplace seen this level of individualisation for different drivers. You can assign controls to:

- Tractor functions
- ISOBUS functions
- TeachIn functions for the first time.

A clever colour concept also helps the driver to keep track of the following: The buttons show the colour of the corresponding function group they are assigned to. Save the settings to user profiles for quick lookup. You can also adapt the display areas, including how the terminal pages are arranged.

### More display options

As well as the new standard 12" terminal on the armrest, the large 10" dashboard is now also digital. The genius thing about this is that, in addition to regulation-compliant road data, you can also view machine-related information while you're on the field. For extra display space, use the 12" roof terminal.

### Infotainment package with sound experience

Four high-end speakers and a subwoofer deliver superior sound quality in the cab. Enjoy playback from your smartphone via USB, AUX-IN and Bluetooth. FM/AM/DAB+/HD and two antennas with permanent channel search also ensure the best radio reception. Make phone calls with the fantastic quality hands-free kit: A total of 8 microphones built into the roof liner guarantees the perfect acoustics, picking up your voice every time. The controls are on the terminal or the armrest.





FENDT 700 VARIO

# Taking user friendliness to a whole new level.

**Crossgate lever / 3L joystick**  
There is a crossgate lever or 3L joystick to control the 3rd and 4th hydraulic control units as well as the front loader, depending on the configuration. Together with a Fendt front loader that has a third valve, you can use the 3L joystick to control an unprecedented 3 functions at once. With the additional reverse drive button, changing direction is a smooth and comfortable experience.

**12" terminal**  
Up to 6 freely configurable screens are shown on the standard 12" terminal.

**Infotainment control: Volume/mute**

**Aircon control**

**Pushdial**  
Use the pushdial to manually use the terminals instead of using touch control. You can also switch between the terminals. There are hotkeys for quick navigation.

**All under control – multifunction joystick**  
With its ergonomic shape and position on the armrest, you can hold the all-new multifunction joystick in a relaxed position all day long. It has all the elements you are familiar with, like the 2 auxiliary control units and headland management. The control for the hydraulic valves is proportional. The joystick also has freely assignable buttons to give the driver even more flexibility.

**Front/rear power lift control**

**Gear function control**

**Customisable buttons**  
The buttons are ready to be assigned, so you can adapt your Fendt 700 Vario to suit your work, and have your most common actions right where you need them. A clever light system gives you a visual reminder of functions that have been reassigned to other buttons. This means you can quickly find your way around without any user errors.

**Assign the functions you want (basic setting: hydraulic valve control)**

FENDT 700 VARIO

# Equipment ranges.

For the best workplace to suit your needs, we have four different equipment variants to choose from:

**Power, Power+, Profi, Profi+**

Choose from Setting 1 or Setting 2:



**Power Setting 1**

- No crossgate lever
- One rocker pair (linear module) to control the hydraulic valves



**Power+ Setting 1**

- Crossgate lever
- One rocker pair (linear module) to control the hydraulic valves



**Profi Setting 1/ Profi+ Setting 1**

- Crossgate lever
- Four fingertip spools to control the hydraulic valves



**Power Setting 2**

- Crossgate lever
- No rocker pair (linear module) to control the hydraulic valves



**Power+ Setting 2**

- 3L joystick
- One rocker pair (linear module) to control the hydraulic valves



**Profi Setting 2/ Profi+ Setting 2**

- 3L joystick
- Four fingertip spools to control the hydraulic valves

# FendtONE

## Seamlessly connecting office and machine.



Whenever you buy a product or service with the Fuse logo, you can enjoy guaranteed open connectivity and compatibility within our core brand ranges as well as with other manufacturers' products. To find out more, go to [www.FuseSmartFarming.com](http://www.FuseSmartFarming.com)

**Consistent and intuitive operating philosophy**  
For the first time, the new FendtONE platform merges your machines and your office into one control unit. FendtONE combines the familiar operation of the tractor with the terminal for planning or control tasks that classically would take place in the office. You can schedule field data and orders on your computer or smart device wherever you are, and send them to your machine. You see the same screen in the driver's cab (onboard) as you do in the office or on the move (offboard). FendtONE helps you comply with legal documentation requirements and optimises your entire work processes.

**Practical advantages at a glance:**

- Intuitive and uniform operation (same buttons in the same place with the same icons)
- Centralised maintenance of master data (field data, machines, etc.)
- Easily send data to the machine terminal and vice versa - wherever, whenever
- Open and vendor-independent system, with the option to manage mixed fleets
- Data sovereignty always lies with the customer

The counterpart to the new driver's workstation on the tractor (onboard) is the offboard-side FendtONE platform\*. You can access this modular application at [www.fendt.one](http://www.fendt.one) either from your office or on an app on your mobile device. With FendtONE Offboard, you can manage field, order and machine data and organise your team. The operating logic is the same as on the tractor terminal. The same overview manager is there to help you adapt the homepage to your individual needs.

OFFBOARD



**Use it wherever you are, and on any device (tablet, mobile phone, PC)**  
Seamless data transfer makes it possible to manage waylines or create orders from any location.



ONBOARD

**On the machine (terminal)**  
Ready for the future with the new 12" terminal! For more display space, integration and flexibility.

**Use FendtONE Offboard in conjunction with the agrirouter**

The interface between FendtONE Offboard and the agrirouter expands your options. In the future, you'll also be able to map mixed fleets\* in FendtONE and use them in your order management. You can also connect other agricultural software solutions\* to the FendtONE Offboard application. Use FendtONE initially as an easy introduction to job-specific documentation, and later transfer data from FendtONE to advanced farm management systems for further processing.

\* Provided that the agricultural machinery or software manufacturer is registered with the agrirouter. To find out more, go to [www.my-agrirouter.com](http://www.my-agrirouter.com)



## Tailored to your needs

Fendt Smart Farming Module	Optional
<b>Guidance system basic package</b> • Equips the tractor for lane guidance and the Fendt Guide application	• Choice of different receivers (NovAtel or Trimble) • Fendt Contour Assistant • Fendt TI • Fendt TI Headland (Fendt TI Auto) *
<b>Agronomy basic package</b> • Includes the TaskDoc and Fendt Task Manager apps • Create orders and follow-up reports on the machine • Full overview of completed jobs	• NEXT Machine Management • agrirouter
<b>Telemetry basic package</b> • For the best analysis and optional fleet management • Use Fendt Connect to display and store data such as machine position, fuel consumption, speed and error codes • Storage to evaluate work processes and machine condition • Data is sent via the mobile network, so you can check machine data wherever you are	
<b>Machine control basic package</b> • Prerequisite for additional ISOBUS functions • Simple and intuitive control of ISOBUS attachments with standardised cross-vendor interface as per Standard ISO 11783 • Tractor terminal and implement are connected by one socket at the rear (and at the front if applicable)	• Fendt SectionControl (SC) • Fendt VariableRateControl (VRC)

\*Initially featuring Fendt TI Auto



**Choose from 4 modules**

In the field of smart farming, Fendt offers you a wide range of products to help you use your machine even more purposefully and at the same time work more comfortably. A total of 4 modules are available, which you can select as needed:

**Guidance System – Agronomy – Telemetry – Machine Control**

Each module includes a basic package of the startup applications you need. You can also extend the modules with optional extras.

# Guidance system

For those who prefer precision.

You can configure your Fendt lane guidance system to suit your needs. Equip your system with either a NovAtel or Trimble satellite receiver. Depending on your work and individual requirements, you can choose from correction signals with different accuracy levels.

## NovAtel® receiver



**NovAtel® Standard**  
Correction signal: SBAS (EGNOS & WAAS)  
± 15-30 cm track to track accuracy; ± 150 cm repeatable accuracy

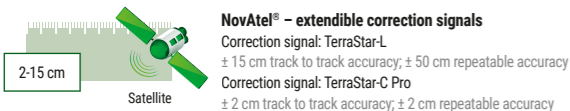

**NovAtel® – extendible correction signals**  
Correction signal: TerraStar-L  
± 15 cm track to track accuracy; ± 50 cm repeatable accuracy  
Correction signal: TerraStar-C Pro  
± 2 cm track to track accuracy; ± 2 cm repeatable accuracy

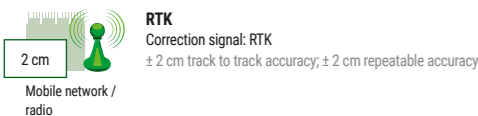

**RTK**  
Correction signal: RTK  
± 2 cm track to track accuracy; ± 2 cm repeatable accuracy

## Trimble® receiver



**Trimble® Standard**  
Correction signal: SBAS (Egnos & Waas)  
± 15-30 cm track to track accuracy; ± 150 cm repeatable accuracy



**Trimble® – extendible correction signals**  
Correction signal: RangePoint® RTX  
± 15 cm track to track accuracy; ± 50 cm repeatable accuracy  
Correction signal: CenterPoint® RTX and CenterPoint® RTX Fast  
± 2 cm track to track accuracy; ± 2 cm repeatable accuracy

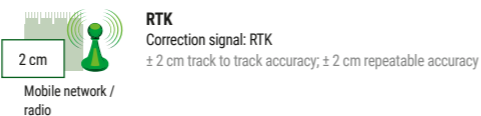

**RTK**  
Correction signal: RTK  
± 2 cm track to track accuracy; ± 2 cm repeatable accuracy

**Because the receivers are installed under the roof hatch, they are fully protected against theft, weather and damage.**

Two main factors are decisive for farming:

- Track-to-track accuracy: Shows how precise the contacts are from one track to the next
- Repeatable accuracy: Specifies how accurately you can repeat an existing wayline or field boundary from the previous year.

# Agronomy

Save time in the office.

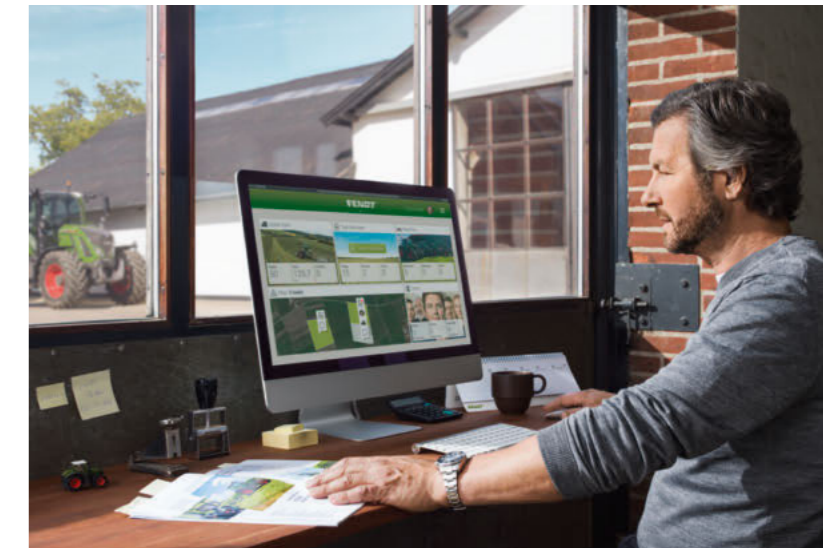

## FendtTI headland management system

Save recurring processes and activate them when you want:

- Create the best processing sequence manually from standstill, or record and save it while driving
- Activate your defined work sequence at the push of a button
- Fendt TI in combination with Fendt Guide (Fendt TI Auto): Automatically introduce all recorded steps at the headland with position detection

## Fendt Guide Contour Assistant

The Fendt Guide Contour Assistant software option adds Contour Segments and Single Track to the familiar wayline types.

### Contour Segments wayline

You can use the Contour Segments wayline to record each segment and track in a one-off circumnavigation of the field, or apply them directly from the existing field boundary.

- No need to record different waylines to edit different sections of the field
- No need to manually switch between waylines as you work the field
- Summary of all relevant tracks for one unit
- Contour Assistant automatically detects the right track

### Single Track wayline

Use Single Track to record an almost endless track with an open contour:

- Ideal for plant protection, as you can record a single track and apply it to the whole field

## Fendt TaskDoc: Skip all that paperwork

With the order-led documentation system Fendt TaskDoc, your tractor collects all necessary data as you work. You can then transfer the data as a standardised file into a field map – either via a USB stick, Bluetooth or wirelessly over the mobile network.

## Simple order management: Fendt Task Manager

If your machine is equipped with the basic agronomy package, you can create orders on the go or from the office in just a few clicks and send them wirelessly to the machine. Completed jobs can then be returned from the machine to the FendtONE Offboard app. From there, a job report shows you more details, including which fields were worked and the output volumes. The map view also gives you an overview of the selected parameters.

# Machine control

Perfect interaction of tractor and attachment.



**ISOBUS interfaces**

The Fendt 700 Vario has an ISOBUS socket at both the front and rear.

**With SectionControl**

Clean contacts, even on awkwardly sectioned fields.



**No need for an external ISOBUS terminal**

The additional 12" roof terminal offers you even more display space. You can show your ISOBUS attachment data on the roof terminal, for example, while the terminal on the armrest shows the lane guidance. External terminals are no longer needed.

Fendt ISOBUS is a standardised plug & play interface between the tractor and the attachment: Simply connect the ISOBUS plug to the ISOBUS socket, and the control screen of the attachment appears in the terminal.

**Pinpoint precision: Fendt SectionControl**

SectionControl (SC) provides automated section control for ISOBUS implements. Fendt SectionControl supports up to 36 partial widths. The ISOBUS standard promises intuitive handling: The control screen automatically appears in the terminal when you connect the ISOBUS plug to the socket. All you need to do is flip a switch to start.

**How you benefit from Fendt SectionControl**

- Savings of up to 15% in resources by avoiding unwanted overlaps
- Reduces the threat of disease, pests and weeds by avoiding overly dense crops and missed sections
- Less effort for the driver, so they can fully concentrate on monitoring the implement

- Improves the quality of work with clean contact at the headland
- Headland mode: Option to work the inner field first, then the headland

**Make full use of your tractor's potential: Fendt VariableRateControl**

VariableRateControl controls the output volume of resources (seeds, pesticides, fertilisers) for each subsection of field. To benefit from this smart solution, you need Fendt TaskDoc and an ISOBUS TC-GEO standard licence.

**The advantages of Fendt VariableRateControl**

- Increase your efficiency: Maximise yield while saving resources
- Save time: Use the job report as a reporting basis to meet legal requirements (e.g. Fertiliser Regulations)
- Flexibility: Compatible with ISO XML and Shape files

**How it works**

VariableRateControl works from a field map that gives the best output volumes for the different field zones and shows them in different colours. You create this map on a farm management system before you start the work (e.g. NEXT Machine Management). You can draw on your own knowledge of the field or use data from soil samples, satellite data, etc. Then use the mobile network or Bluetooth to send the field map to the Fendt terminal as a standardised ISO-XML file. The TC-GEO Task Controller automatically controls the output volumes depending on the position. Once the field is worked, you can send a report back to your farm management system to clearly document your work. Fendt VariableRateControl can handle up to five different products at the same time.

# Telemetry

Optimise your machine use.

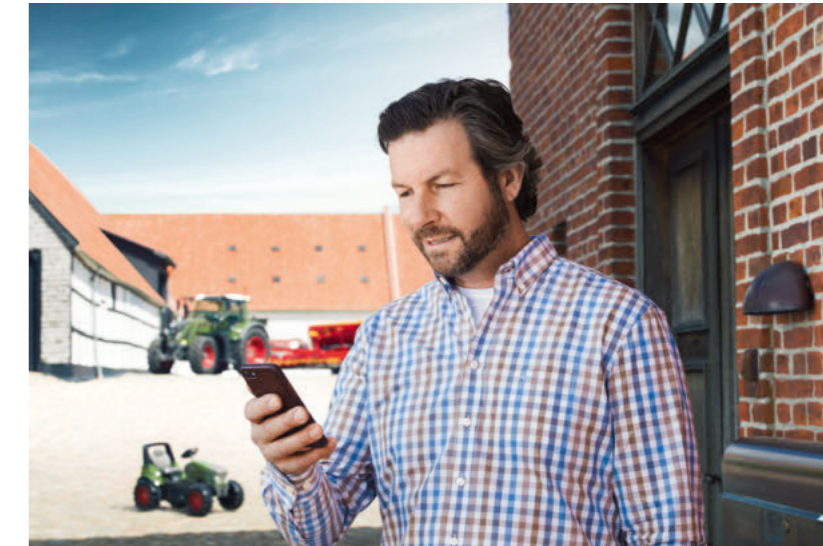

**Call up machine data from any location:**

**Fendt Connect**

Fendt Connect is the central telemetry solution for Fendt machines. With Fendt Connect, machine data is collected and evaluated, so farmers and contractors can monitor, analyse and optimise the condition and use of their machines.

**Fendt Connect tells you about:**

- Machine position and route
- Fuel consumption and AdBlue level
- Speed and working time
- Machine capacity
- Error messages
- Upcoming service intervals
- etc.



**Fendt Connect**

Mobile data transmission means you can check your realtime machine data anywhere – from a PC, tablet or smartphone.

# Cab.



**Cab suspension – choice of 2 versions:**

Pneumatic: cone bearing at the front, pneumatic cab suspension at the rear;  
4-bearing cab, pneumatic comfort: 3-point pneumatic cab suspension (central swingarm front and 2 rear compressed air struts)



**Cab configurations – choice of 3 versions:**

Panorama cab VisioPlus: Windscreen and right cab side do not open  
Panorama cab VisioPlus + right door: right door opens, windscreen does not open  
Standard cab VisioPlus: right door and windscreen open

**Electrically adjustable rear view mirrors**

The rear-view mirrors with separate wide-angle mirrors ensure the best overview and maximum safety. Adjust them easily in the terminal or by using the pushdial.



**Swivel steering column with digital dashboard**

The digital dashboard moves with the steering wheel. This means every driver can adjust the height and tilt to suit them, promising perfect ergonomics, every time.



**Camera connections**

The 4 camera connections (2x digital, 2x analogue) in the roof liner show the sent image in extremely high resolution in the terminal.



**Flexible data transfer**

To import your field data, you can use 4 USB ports in the armrest in addition to the Bluetooth and mobile network options. You can also use the ports to charge your tablet or smartphone.

# Lighting and hitch systems.



**2 programmable lighting modes**  
Use the switch on the reverse lever to quickly toggle between two stored lighting modes, including road and field mode.



**The best lighting**

More light to work by – delivered by the 360° LED lighting concept on the Fendt 700 Vario. Premium quality LED headlamps offer a wide view as well as increased safety on the road. They are especially bright yet low-impact and long lasting.



■ Short ball head coupling (with/without forced steering connections)



■ Retractable drawbar Cat. 3



■ Piton Fix drawbar



■ Hitch



Long ball head coupling (with/without forced steering connections)



Offset drawbar Cat. 3



Piton Fix Heavy duty

# Front axle suspension and ballast.

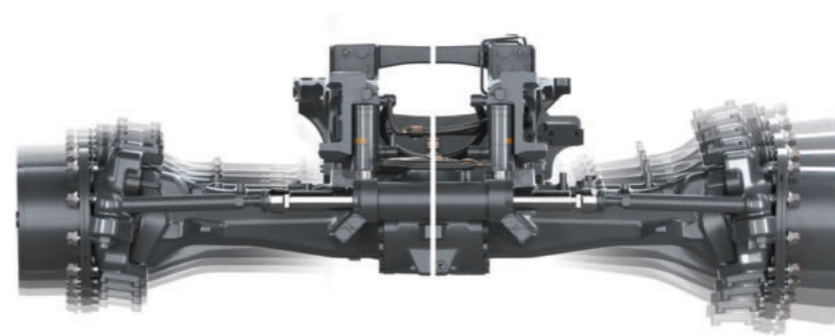

**Front axle suspension**

The front axle suspension provides consistent suspension comfort no matter what the load or attachment, with position sensors controlling the level. This avoids any power hopping, increasing the tractive force on the front axle by up to 7% (compared to a front axle without suspension).



■ 870 kg



■ 1250 kg



■ 1800 kg

**Various ballast options**

There are different front and wheel weights available for the Fendt 700 Vario.



2 x 200 kg (Fendt 714 Vario and Fendt 716 Vario only)



2 x 300 kg



2 x 600 kg



FENDT SERVICES

The best product with the best care and service.

With Fendt, you get a cutting edge product that will overcome the toughest of challenges. That's why you can expect that little bit extra when it comes to services from highly-efficient, certified Fendt dealers –

- with fast lines of communication between you and our trained service team.
- 24/7 availability of replacement parts throughout the season
- 12-month warranty on Fendt original parts and their fitting

**100% quality. 100% service: Fendt Services**  
We offer outstanding services to offer you the best possible reliability of use and efficiency from your Fendt Machine:

- Fendt Demo service
- Fendt Expert operator training
- AGCO Finance – finance and lease deals
- Fendt Care – servicing and guarantee extensions
- Fendt Certified - Pre-owned machine programme



+44 330 123 9909

Your Fendt dealers are always there when you need them, and have just one aim – to make sure your Fendt machines are ready for action at any time. If something does go wrong during harvest time, simply call your certified service centre 24/7 on the emergency hotline.

FENDT SERVICES

# Rest assured that your machine will be ready for action tomorrow.

Using the smartphone app "AGCO Parts Books to go", you can find Fendt spare parts quickly and easily and order them directly. The app is available for download in the app store and in the Google Play Store. Your personal access data is available from your Fendt dealer.

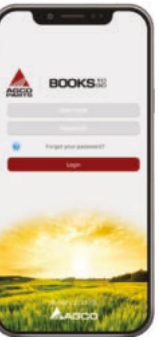

**Fendt Demo service**

Is this a new purchase? You'll love our Fendt solutions and overall efficiency. Let the Fendt Demo service make the decision easier.

**Fendt Expert operator training**

We help you get the most out of your vehicle. With the help of our exclusive Fendt Expert operator training programme, you can optimise the efficiency of your Fendt even further, and get to know all the functions to make your daily routine that much easier. Our team of professional trainers will advise you on how to use your Fendt machine to its full potential.

**Individual finance and lease models**

Investing in technology means a considerable capital outlay. A credit finance agreement from AGCO Finance offers attractive conditions and flexible terms. From the initial down payment to monthly instalments to the payment term – you set the general terms on which to finance your Fendt. If you need additional resources in a hurry or want to use tractors over a long-term period without purchasing them, your Fendt dealer can offer the ideal solution with tailored lease packages.

**Fendt Certified - Pre-owned machine programme**

Leaders drive Fendt – including with pre-loved agricultural machinery. Used agricultural machinery to tried and tested high-quality standards and certified Fendt quality – the ideal solution for cost-conscious farmers or as an addition to a growing fleet.

The benefits:

- Certification according to strict quality standards
- Extensive incoming check (technology, wear, appearance)
- Fully serviced wear parts
- If required, replace, clean and paint components
- One-year warranty (option to extend)

**Fendt Care – servicing and guarantee extensions**

To keep your machine ready for action at any time, we offer a tailored maintenance and repair service beyond the statutory warranty. This only covers the repair risk of a new machine for the first 12 months after delivery. That's where Fendt Care comes in. With flexible durations and flexible rates with and without excess, the machine can be guaranteed even after the first year. Your Fendt dealer will only install Fendt original parts. These have a proven standard of quality and are safety-tested. This ensures the best value retention for your Fendt machine.

## Full control over costs and planning reliability

Fendt Care	Bronze	Silver			Gold <sup>1</sup>	Platinum <sup>1</sup>
Output	Regular maintenance, fixed maintenance costs	Cover against the risk of repair (excludes wear)			All costs covered (except wear and tear)	Costs and availability covered (except wear and tear)
Benefits	Reliability of use	Coverage against major damage	Full coverage under great conditions	Full protection while you keep costs under control	Protect against all unexpected repair risks including all secondary costs	For customers who can't afford to down tools
Regular maintenance	✓	✓	✓	✓	✓	✓
Repair costs		✓	✓	✓	✓	✓
Excess		€490	€190	€0	€0	€0
Travel costs, recovery/towing, troubleshooting with added diagnostics tools, performance testing, oils and filters, if engine/gearbox is repaired					✓	✓
After hours and weekend surcharge						✓
Replacement machine						✓

<sup>1</sup> Valid for UK, Germany and France. Platinum only available at participating dealers.



8 years / 8,000 operating hours

With our new Fendt Care rates, Fendt offers extensive coverage for the reliability and repair risk of new machines. Fendt Care gives you complete cost control with exceptional service. From a service agreement to the full carefree package including replacement machine, Fendt has a flexible and tailored solution for your fleet.



# Quick and simple servicing.



A swing-up bonnet and removable side panels provide excellent access to the engine compartment. This means you can quickly and easily remove the air filter.



The radiator is also easy to access when it needs cleaning.

# Fendt extras.



Fendt extras are a great addition to your Fendt machine. Choose from an extensive range of products including lubricants, AdBlue, care kits, cab accessories and much more. All extras are available for purchase exclusively from your Fendt dealer.



# What can we do for you?

### What makes Fendt Services different?

For us, service means knowing and understanding your work in order to meet your demands for reliability and safety and to act in your economic interest. We stand behind our products and have developed them for the highest demands and long-term operation. Our service is the partnership aspect for your work.

### How do I get a software update?

Fendt software is update-compatible, so your Fendt always features the latest technology. This ensures that your Fendt machine is technologically advanced, that it maintains its value, and keeps your investment as up to date in the future as it was on the first day you bought it. Contact your Fendt dealer for details.

### What is Fendt Expert?

Become an expert on the Vario Profi with Fendt Expert driver training: Are you already familiar with all the functions that the technology has to offer? Take advantage of the technology in every Fendt Vario and learn how to make best use of every feature, with Fendt Expert. Our team of professional trainers will advise you on how to use the full potential of your Fendt tractor. Contact your dealer for details and register today.

### fendt.com

Find everything online – from brochures to technical specifications, from reports about customers or our company to our Fendt event calendar.

### Fendt Configurator

With the Fendt Vehicle Configurator, you can choose from all the available equipment variations and put together the optimally equipped vehicle for your farm. The Fendt Configurator is available online at [www.fendt.com](http://www.fendt.com), where you will find a quick link to it directly on the start page.

### fendt.tv

Fendt around the clock – our Fendt Media Library makes it possible. Our Internet TV provides you with news and information about Fendt 24/7.

### Test drives

Go to [fendt.com](http://fendt.com) and select "Fendt Services" on the "Service" page, select the "Demo Service", then register for a test drive with the tractor of your choice.





## Equipment variants and technical details.

Dear customer,

Our motivation at Fendt is to provide you with the most innovative machines and solutions so that you can do your work even more efficiently and comfortably. We are constantly advancing our products and their equipment details. Therefore, you will find all technical data and equipment variants updated daily on our website.



Simply scan the QR code or follow the link below:  
[fendt.com/700-vario-gen6-data](https://fendt.com/700-vario-gen6-data)

# FENDT

## Leaders drive Fendt.



[www.fendt.com](http://www.fendt.com)

AGCO GmbH – Fendt Marketing  
87616 Marktoberdorf, Germany

EN/2002

 **AGCO**  
Your Agriculture Company

Fendt is a worldwide brand of AGCO.

All details regarding scope of delivery, appearance, performance, dimensions and weights, fuel consumption and running costs of vehicles reflect the latest information available at the time of print. These may change by the time of purchase. Your Fendt dealer will be happy to inform you about any changes. The vehicles shown do not feature country-specific equipment.