

CUB

COMPACT UNLOAD BELT

39' | 44' | 49' lengths

AGI Batco is proud to offer the BCX³ CUB Field Loader for ultra-low bin unloads. This Compact Unload Belt (CUB) has been engineered with a lower hitch-end and tight hopper design to accommodate even the lowest bin unloads while keeping grain on the belt.

FEATURE	ADVANTAGE	BENEFIT
URETHANE HOPPER SEALS	Urethane seals are precision-made to seal the belt to the hopper bed	These long lasting seals keep grain on the belt, reducing the chance of the grain spilling/leakage
URETHANE FLASHING	Highly durable, custom molded urethane flashing fits both sides of the hopper - no more lefts and rights	Keep it simple when replacing flashing and order the same number for both sides
INNOVATIVE CUB HOPPER GEOMETRY	Designed specifically for ultra-low bin unloads, the BCX ³ CUB (Compact Unload Belt) works to fit underneath even the lowest bin unloads	The redesigned lower "hitch-end" profile allows the hopper to better fit under shorter bin unloads and the new intake design maximizes grain flow with the least amount of disruption along the sides
REDESIGNED BELT TAKE-UP	New design lets you easily set the belt take-up tension with the adjuster bolt and offers several feet of belt take-up to spare	No more guessing at what the belt take-up tension should be with the help of the take-up tension indicator! The spring-loaded belt take-up will allow the belt to shrink without putting extra pressure on your belt lacing
NO NONSENSE HOOD	Uses proper geometry to allow the grain to freely flow straight down into the truck	Trucks can line up straight under the discharge instead of off-center from the conveyor, eliminating the need for a downspout and increasing the capacity by decreasing the working angle
UNDER HOPPER SKID PLATE	Skid plate stops any debris from touching the bottom of the belt under the hopper	Reduced risk of gravel/dirt/debris getting onto the belt from the underside while protecting the belt from damage
UNIVERSAL MOTOR MOUNT	Fits most brands and sizes of 10-12 HP electric motors	Easily adjustable and more flexible to accommodate a range of motor sizes
PINCH TOP DRIVE	Drive roller and pinch roller track together instead of separately	Removable top plate gives easier access to the top drive roller and the pinch roller mount plate is easier to assemble and adjust
FRAME	Identical frame as 1539, 1544, and 1549	The frame you know and trust will also give you more accessible stock parts
HITCH	Short compact hitch	The hitch tongue is removable, allowing the hopper to get as close as possible to the bin for unloading

OPTIONAL FEATURE

TURBO CLEAN WASH SYSTEM

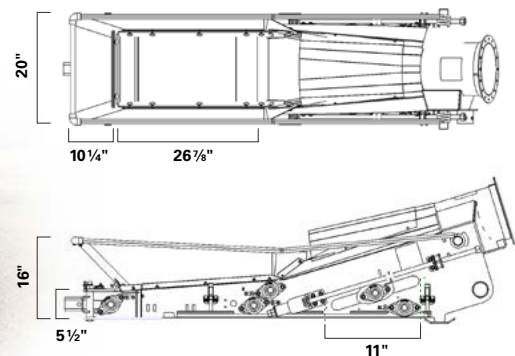

AGI  **BATCO**

BCX³ CUB CONVEYORS

PART #	MODEL	BELT LENGTH	HITCH WEIGHT* (LBS)	DOWN - TRANSPORT		UP - OPERATION		WIDTH (FT)	HP ELEC
				A** (FT)	B (FT)	A** (FT)	B (FT)		
15503953	1539 CUB	81' 3"	90	11.3	16.1	15.1	19.1	7.5	10
15504453	1544 CUB	91' 3"	90	12.9	18.3	19.8	18.2	7.5	10/12.5
15504953	1549 CUB	101' 3"	100	13.1	20.4	19.5	21	7.5	12.5

*With AGI supplied electric motors



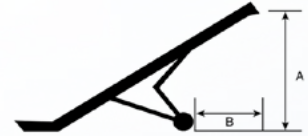

**A in "Down - Transport" position is measured from the ground to the highest point on the conveyor, A in "Up - Operation" is measured from the ground to the bottom of the hood



BATCO is an AGI Brand.

AGI is a leading provider of equipment solutions for agriculture bulk commodities including seed, fertilizer, grain, and feed systems with a growing platform in providing equipment and solutions for food processing facilities. AGI has manufacturing facilities in Canada, the United States, the United Kingdom, Brazil, India and Italy and distributes its products globally.

Box 1750, Swift Current Saskatchewan, Canada S9H 4J8
 1.855.432.1990 | sales@batco-rem.com | aggrowth.com/batco

AGGROWTH.COM aggrowthintl     

AGI BATCO