

FALL 2016 CATALOG

From Our Family To Yours For Over 40 Years

PolyTech
Joshua 24:15



**50-60%
LIGHTER
than other
models!**

31 STUBBLE STOPPERS



**Restores worn
housing to
"like new"
condition!**

1 AUGER TUBE LINERS



**Cover your
existing
auger floor!**

21 GRAIN TANK LINERS



***Inventory in Georgia & Minnesota
for Faster Delivery!***

800.542.7659
POLYSKID.com

QUICK REFERENCE INDEX

 1 Auger Tube Liner	 4 Deere 200 900/900F	 5 200/900 900F Green	 6 John Deere 600 Series	 8 CIH 1020 Skids
 16 Case Auger Bed Liner	 17 JD Auger Bed Liner	 17 Case 1020 Feed Plate	 18 Grain Grabber 2	 18 Tru Tube Tool
 29 Poly Clean Out Door	 29 Clean Grain Elevator Auger Cover	 31 Stubble Stoppers	 37 Stalk Stomper Replacement Shoes	 37 Case Corn Head Liners
 44 Strip-Till Accessories	 47 Ripper Shins & Covers	 51 Drill Drain	 51 Tungsten Scrapers	 52 Peanut Combine Parts

 **COMBINE**

 **CORN HEAD**

 **TILLAGE**

 **PLANTING**

 **PEANUT**

 **COTTON**

 **HARDWARE**

 **MATERIAL**

 **TOOLS/SAFETY**

 9 CIH Stabilizer Cover	 10 New Holland Skids	 11 Mac Don Skids	 12 AGCO Skids	 15 Feeder House Kit
 19 Poly Auger Fingers	 21 Grain Tank Liners	 22 AGCO Grain Tank Liner	 23 Auger Trough Liners	 27 Poly Auger Wear Shoes
 39 JD Corn Head Liners	 41 AGCO Corn Head Liner	 42 Hood Patch Kits	 42 Corn Head Snout Guards	 43 Poly Moldboard Cover
 54 Cotton Picker Parts	 59 Hardware	 62 Poly Last™ Sheets	 63 Tools & Safety	

Custom Tube Liners Up To 16" Diameter and 102" Long

- Comes pre-assembled for quick and easy installation.
- Can be installed without removing auger in most applications.
- Restores worn housing to "like new" condition.
- Self adjusts to accomodate worn or new housings.
- Stainless steel hardware for extended service life.

Available diameters: Custom fit from 8" to 16"

Available lengths: from 18" to 102" in 2" increments.



CUSTOM TUBE LINERS

Diameter	Price
8" - 9 3/4"	\$ 97.00 ft.
10" - 11 3/4"	\$102.00 ft.
12" - 13 3/4"	\$124.00 ft.
14" - 16"	\$155.00 ft.

*Depending on dimensions, custom liners are subject to oversize shipping charges.



New kits may have been added after the printing of this catalog. Please visit our website at www.polyskid.com for a list of current kit availability.

**COMBINES, GRAIN CARTS,
TRANSPORT AUGERS...
ANYWHERE THERE'S
TUBE WEAR!**

Designed for a custom fit in worn or misshaped tubes!

- Installs in about an hour.
- Restores worn housing to "like new" condition.
- Adjustable to accomodate worn or new housings.
- All stainless fasteners and hardware for extended service life.

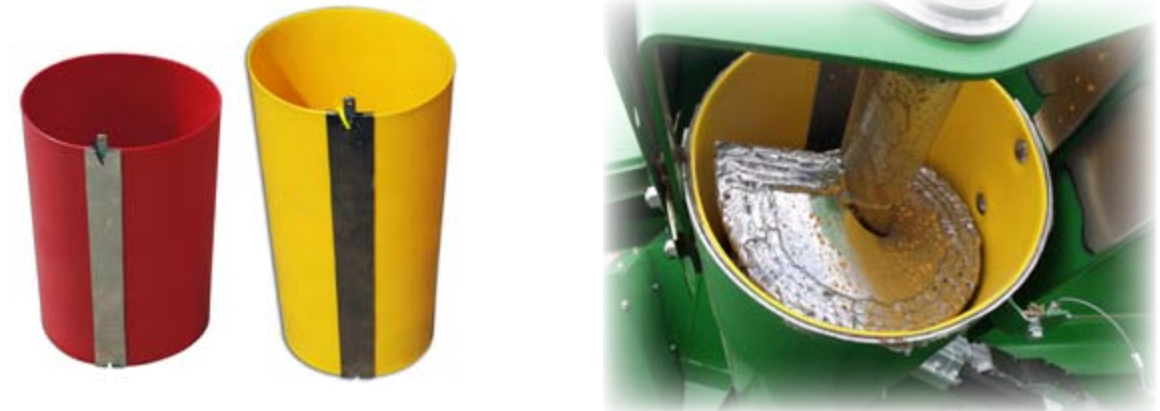

JOHN DEERE TANK FILL TUBE LINER

Part #	Description	Price
TFJK001U	Tank Fill Tube Liner - 24" fits John Deere 9550, 9560STS, 9570STS, 9650, 9650CTS, 9650STS, 9660, 9670, 9660STS, 9750STS, 9760STS & 9860STS	\$205.00
TFJK002U	Tank Fill Tube Liner - 24" fits John Deere 9770 & 9870	\$205.00
TFJK003U	Tank Fill Tube Liner - 24" fits John Deere 7720	\$195.00
TFJK004U	Tank Fill Tube Liner - 24" fits John Deere 9400, 9500, 9500SH	\$195.00
TFJK005U	Tank Fill Tube Liner - 24" fits John Deere 9600 & 9610	\$195.00
TJFK006U	Tank Fill Tube Liner - 24" fits John Deere S670, S680, S690	\$205.00

CASE IH TANK FILL TUBE LINER

Part #	Description	Price
TFCK001U	Tank Fill Tube Liner - 18" fits Case IH Models 1660, 1666, 2144, 2166, 2344 & 2366 with Inclined Fill Tube Option & ALL 1680, 1688, 2188, 2377, 2388, 2577 & 2588 Models <i>*Does not fit the horizontal fill tube</i>	\$155.00

***Liners on this page are available in longer lengths upon request. (May be subject to oversize shipping charges).**

ALL POLY SKIDS ARE NOT CREATED EQUAL

It's true. You can buy other poly skids. But, if you're interested in the long term profitability of your operation, you'll want to get the facts before you spend your hard earned money. Poly Last™ combine skids from Poly Tech are designed to fit better and wear longer than any other poly skid.

The fact that longer wear life is better is simple enough. What most people don't think about is: Why fit is so important! The primary purpose of poly skids is to allow your header to ride directly on the ground without sticking or pushing. This allows you to harvest more of your crop, especially the portion growing closest to the ground. The cutter bar reaches it's optimum cutting depth just above the surface of the ground. Very much like a quality razor produces a close shave, you want to eliminate as much stubble as possible.

Other poly skids can fit poorly causing a gap between the poly and the steel. As dirt and trash are trapped, a packing effect begins to push the poly even further away from the steel. The distance between the poly and the steel (as much as 1/2" or more) is what keeps your cutter bar from reaching it's optimum cutting depth.

Poly Last™ skids have a glove fit to eliminate the gaps that cause problems. Your combine head is free to ride the ground and your cutter bar can reach its optimum position next to the ground. Your crop goes where it belongs: in your grain tank and ultimately in your bank account.

Poly Last™ Combine Skids FIT BETTER & WEAR LONGER



Competitor's Fit - Gap raises cutter bar and wears quicker.

Poly Tech Fit with Patented "Living Hinge" Gets low and wears even.

CUTTING CLOSE MEANS MORE BEANS IN THE BANK!

Does it make sense to pay \$100 or even \$200 less for a "bargain" only to walk across your field after harvest and see thousands of dollars of your crop still lying in the field?

If you harvest a minimum of one extra bushel per acre, which you can sell for \$14.00 per bushel; and you're harvesting 600 acres; Is it worth \$8,400.00 to invest a little more in Poly Last™ combine skids?

Use this formula and do your own math. The numbers will be different for everyone. But, the results will always improve your bottom line. WE GUARANTEE IT! If not, you have every right to return the product for a full refund or exchange. These are the facts. We don't cut corners to produce a cheaper product. We design and build products that work. If quality matters then you need a Poly Last™ product.

JOHN DEERE 200/900/900F POLY LAST™ COMBINE SKIDS

YELLOW 200/900 FLEX HEADS

Serial # Below 685000

Part #	Description	Price
ASJ99130	13' Deere 200/900	\$470.00
ASJ99150	15' Deere 200	\$514.00
ASJ99155	15 1/2' Deere 900	\$526.00
ASJ99160	16' Deere 200	\$537.00
ASJ99180	18' Deere 200/900	\$578.00
ASJ99200	20' Deere 200/900	\$596.00
ASJ99220	22' Deere 200/900	\$694.00
ASJ99240	24' Deere 200/900	\$748.00
ASJ99250	25' Deere 900	\$776.00
ASJ99300	30' Deere 200/900	\$903.00

Kit includes: Patented Yellow Poly Last™ Covers with "Living Hinge" technology, end skids, wobble box cover, hardware and instructions.

Please provide Serial # when ordering.

YELLOW 900 'F' SERIES

Serial # 685000 & Higher

Part #	Description	Price
ASJ99155F	15 1/2' Deere 900F Serial# 685000+	\$526.00
ASJ99180F	18' Deere 900F Serial# 685000+	\$578.00
ASJ99200F	20' Deere 900F Serial# 685000+	\$596.00
ASJ99220F	22' Deere 900F Serial# 685000+	\$694.00
ASJ99240F	24' Deere 900F Serial# 685000+	\$748.00
ASJ99250F	25' Deere 900F Serial# 685000+	\$776.00
ASJ99300F	30' Deere 900F Serial# 685000+	\$903.00

Part #	Description	Price
APJ99250F	52 1/2" Yellow Panel 900F Serial# 685000+	\$156.00
AWBJF	Wobble Box Cover Yellow 900F Serial# 685000+	\$ 87.00
AESJDRF	Right End Skid Yellow 900F Serial# 685000+	\$ 18.00



Made from Yellow Poly Last™ 100% Virgin, UV Protected UHMW

Replacement Panels include hardware.

Part #	Description	Price
APJ990863	8 5/8" Yellow Panel	\$ 31.00
APJ991763	17 5/8" Yellow Panel	\$ 54.00
APJ992025	20 1/4" Yellow Panel	\$ 61.00
APJ992063	20 5/8" Yellow Panel	\$ 62.00
APJ995000	50" Yellow Panel	\$139.00
APJ995250	52 1/2" Yellow Panel	\$156.00
AESJ9L	Left End Skid Yellow/900	\$ 23.00
AESJ9R	Right End Skid Yellow/900	\$ 17.00
AESJDR	Right End Skid Yellow	\$ 18.00
AWBJ	Wobble Box Cover Yellow	\$ 87.00
AESJL	Left End Skid Yellow/200	\$ 23.00
AESJR	Right End Skid Yellow/200	\$ 17.00

Ask For Poly Last™ Combine Skids with the "Living Hinge."

JOHN DEERE 200/900/900F GREEN POLY LAST™ SKIDS

GREEN 200/900/900F FLEX HEADS

Part #	Description	Price
ASJE99130	13' Deere 200/900	\$316.00
ASJE99150	15' Deere 200	\$356.00
ASJE99155	15 1/2' Deere 900/900F	\$366.00
ASJE99160	16' Deere 200	\$366.00
ASJE99180	18' Deere 200/900/900F	\$410.00
ASJE99200	20' Deere 200/900/900F	\$450.00
ASJE99220	22' Deere 200/900/900F	\$500.00
ASJE99240	24' Deere 200/900/900F	\$544.00
ASJE99250	25' Deere 900/900F	\$553.00
ASJE99300	30' Deere 200/900/900F	\$607.00

Kit includes: Patented Green Poly Last™ covers with "Living Hinge" technology, end skids, wobble box cover, hardware & instructions.

Please specify 200, 900 or 900F series when ordering.

Part #	Description	Price
APJE990863	8 5/8" Green Panel	\$ 26.75
APJE991763	17 5/8" Green Panel	\$ 44.30
APJE992025	20 1/4" Green Panel	\$ 49.45
APJE992063	20 5/8" Green Panel	\$ 52.55
APJE995000	50" Green Panel	\$117.45
APJE995250	52 1/2" Green Panel	\$131.85
AESJE9L	Left End Skid Green/900	\$ 19.60
AESJE9R	Right End Skid Green/900	\$ 16.50
AWBJE	Wobble Box Cover Green	\$ 68.00

Replacement Panels include hardware.

FACTORY CHANGE ALERT!
John Deere 900F series flex headers with Serial # 685000 and higher require several different panels. Please check serial number before ordering.

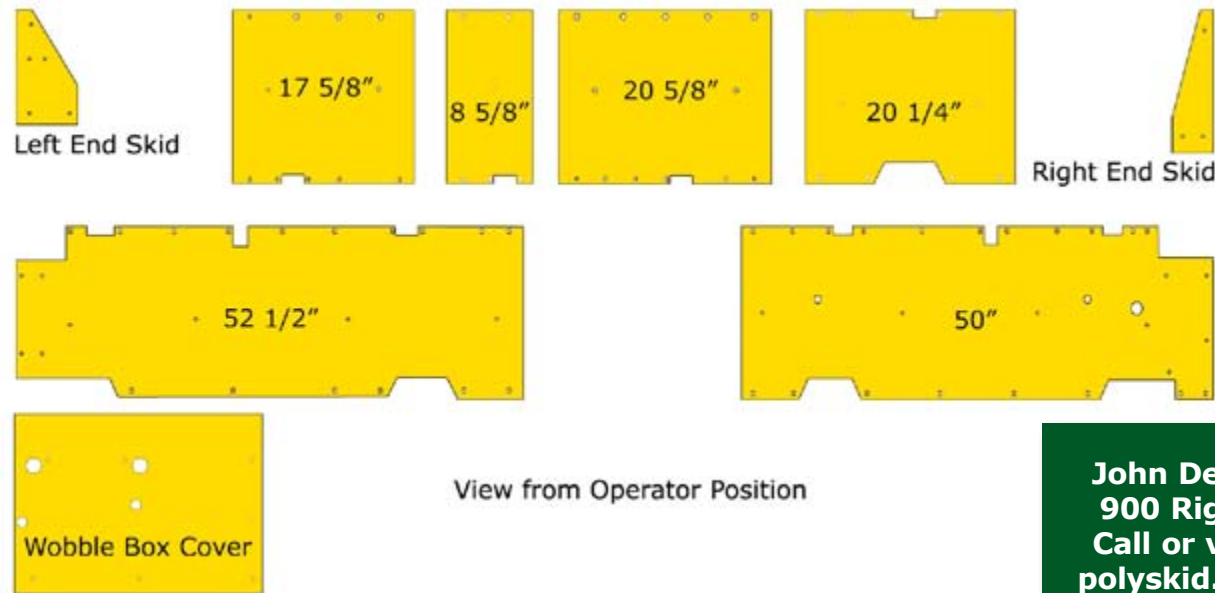

John Deere 900 Rigid-Call or visit polyskid.com for pricing.

THEY FIT BETTER TO GET YOUR JOHN DEERE HEADER CLOSER TO THE GROUND GIVING YOU OPTIMUM CUTTING DEPTH AND MORE BEANS IN THE COMBINE.

The Patented "Living Hinge" is designed to give the skid shoe more flex as it bends to the shape of the factory metal shoe giving it a custom fit to each and every skid on your combine header. It is unlike other skid shoes that have a preformed bend for one size fits all skid shoes.

JOHN DEERE 600 SERIES POLY LAST™ COMBINE SKIDS

JOHN DEERE 600 SERIES FLEX HEAD

Part #	Description	Price
ASJ60180	18' Deere 600	\$325.00
ASJ60200	20' Deere 600	\$350.00
ASJ60220	22' Deere 600	\$380.00
ASJ60250	25' Deere 600	\$411.00
ASJ60300	30' Deere 600	\$484.00
ASJ60350	35' Deere 600	\$566.00

Part #	Description	Price
APJ60501	11" x 16" Yellow Panel	\$23.00
APJ60502	12 1/2" x 33 1/2" Yellow Panel	\$48.00
APJ60696	3" x 14 1/2" Yellow Panel	\$22.00
APJ60626	9" x 12" Yellow Panel	\$18.00
APJ60344	5 1/2" x 9 3/4" Yellow Panel	\$10.00

Replacement Panels include hardware.

JOHN DEERE 600 SERIES RAISED CUT

Part #	Description	Price
ASJ60R200	20' Deere 600 Raised Cut	\$452.00
ASJ60R250	25' Deere 600 Raised Cut	\$540.00
ASJ60R300	30' Deere 600 Raised Cut	\$632.00
ASJ60R350	35' Deere 600 Raised Cut	\$727.00

Kit includes: Patented Yellow Poly Last™ Covers with "Living Hinge" technology, end skids, wobble box cover, hardware and instructions.

Part #	Description	Price
APJ60R244	Deere 600 RC Panel 9 9/16" x 22 1/2"	\$26.00
APJ60R239	Deere 600 RC Panel 12" x 37 9/16"	\$64.00
APJ60R243	Deere 600 RC Panel 3" x 14 5/16"	\$24.00
APJ60R864	Deere 600 RC Panel 11 3/8" x 11 7/8"	\$25.00
APJ60R221	Deere 600 RC Panel 5 1/2" x 10 3/4"	\$13.00
APJ60R225	Deere 600 RC Panel 5 7/16" x 18 1/2"	\$25.00

Replacement Panels include hardware.

JOHN DEERE 600 SERIES FLEX DRAPER HEAD

Part #	Description	Price
ASJ60FD300	30' Deere 600 Flex Draper	\$510.00
ASJ60FD350	35' Deere 600 Flex Draper	\$595.00
ASJ60FD400	40' Deere 600 Flex Draper	\$680.00

Part #	Description	Price
APJ60FD505	3/8" x 9 3/4" x 34.8" Yellow Panel Right Hand fits Steel Part # HXE59505 & HXE30972	\$95.00
APJ60FD506	3/8" x 9 3/4" x 34.8" Yellow Panel Left Hand fits Steel Part # HXE59506 & HXE10619	\$95.00
APJ60FD959	1/4" x 5.973" x 11" Yellow Panel Fits Steel Part # HXE10959	\$13.00
APJ60344	1/4" x 5 1/4" x 9 3/4" Yellow Panel	\$10.00

Replacement Panels include hardware.



Please specify Regular or Raised Cut platform.

CASE IH FLEX HEAD POLY LAST™ COMBINE SKIDS



CASE IH 3152 SERIES RIGID DRAPER HEAD

Part #	Description	Price
ASC8250	25' Case IH 3152 RIGID Draper Head	\$803.00
ASC8300	30' Case IH 3152 RIGID Draper Head	\$945.00
ASC8350	35' Case IH 3152 RIGID Draper Head	\$1,087.00
ASC8400	40' Case IH 3152 RIGID Draper Head	\$1,290.00
ASC8450	45' Case IH 3152 RIGID Draper Head	\$1,372.00

CASE IH 3162 SERIES FLEX DRAPER HEAD

Part #	Description	Price
ASC8300	30' Case IH 3162 FLEX Draper Head	\$945.00
ASC8350	35' Case IH 3162 FLEX Draper Head	\$1,087.00
ASC8400	40' Case IH 3162 FLEX Draper Head	\$1,290.00
ASC8450	45' Case IH 3162 FLEX Draper Head	\$1,372.00

Individual Panels Also Available



CASE IH 3020

CASE IH 2020 SKID SHOES

Serial # Required to Order

Serial #'s BEFORE CBJ020001 & ALL HAJ #'s

Part #	Description	Price
ASC3200	20' Case IH 2020	\$652.00
ASC3250	25' Case IH 2020	\$796.00
ASC3300	30' Case IH 2020	\$955.00

Serial #'s CBJ020001 to CBJ020700

Part #	Description	Price
ASC4200	20' Case IH 2020	\$652.00
ASC4250	25' Case IH 2020	\$796.00
ASC4300	30' Case IH 2020	\$955.00

Serial #'s CBJ020701 to CBJ021300

Part #	Description	Price
ASC5200	20' Case IH 2020	\$652.00
ASC5250	25' Case IH 2020	\$796.00
ASC5300	30' Case IH 2020	\$955.00

DUAL DRIVE

Serial #'s CBJ021301 and AFTER

Part #	Description	Price
ASC6200	20' Case IH 2020	\$ 615.00
ASC6250	25' Case IH 2020	\$ 738.00
ASC6300	30' Case IH 2020	\$ 870.00
ASC6350	35' Case IH 2020	\$1,019.00

SINGLE DRIVE

Serial #'s CBJ021301 and AFTER

Part #	Description	Price
ASC6S200	20' Case IH 2020	\$615.00
ASC6S250	25' Case IH 2020	\$738.00

Kit includes: Poly Last covers, end skids, hardware & instructions.

CASE IH 3020 SKID SHOES

Part #	Description	Price
ASC7200	20' Case IH 3020	\$405.00
ASC7250	25' Case IH 3020	\$489.00
ASC7300	30' Case IH 3020	\$574.00
ASC7350	35' Case IH 3020	\$658.00

CASE IH 1020 FLEX HEAD POLY LAST™ COMBINE SKIDS

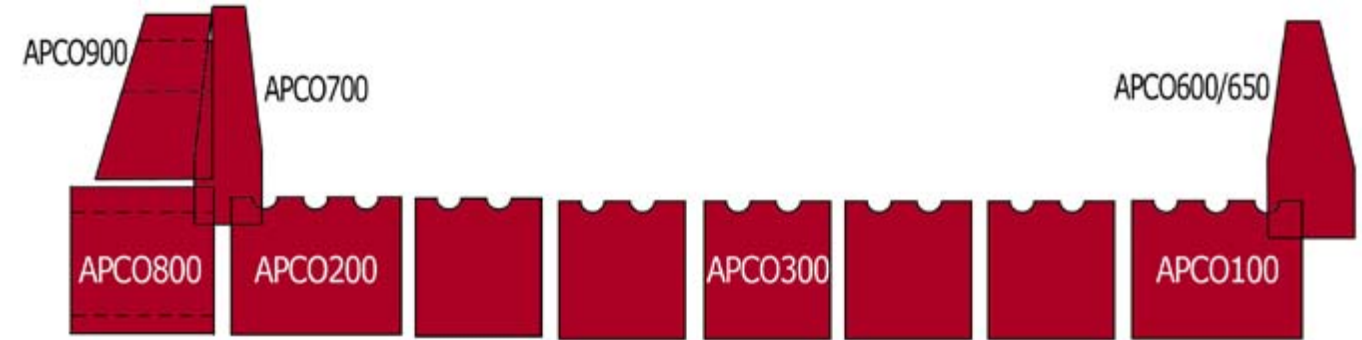

Single kit includes parts for all model years.

Part #	Description	Price
ASC2150	15' Case IH 1020	\$294.00
ASC2165	16 1/2' Case IH 1020	\$319.00
ASC2175	17 1/2' Case IH 1020	\$333.00
ASC2200	20' Case IH 1020	\$372.00
ASC2225	22 1/2' Case IH 1020	\$412.00
ASC2250	25' Case IH 1020	\$450.00
ASC2300	30' Case IH 1020	\$522.00

Kit includes: Poly Last Red covers, left support assembly cover, hardware & instructions.

CASE IH AUXILIARY SKID

Part #	Description	Price
AAC	Case IH Auxiliary Skid Shoe Cover (3 pc. Set) Case IH 1020 Part #1977182C1	\$68.00

Case IH 2142/2152/2162
Skids are made from our Grey Poly Last™ and designed with the help of custom combiners. Our skids will outwear the factory shoe as much as 3 to 1.

Part #	Description	Price
APCO200	8 7/8" x 7 13/16" 1020 Panel	\$20.60
APCO100	8 7/8" x 7 13/16" 1020 Panel	\$18.55
APCO300	5 7/8" x 7 13/16" 1020 Panel	\$15.45
APCO400	5 7/8" x 7 1/16" 1020 Panel	\$13.40
ALSA	26 1/2" x 36 1/2" 1020 Panel	\$92.70
ARSA	20" x 36 1/2" 1020 Panel	\$80.35
APCO650	Right Deflector 1.5" Knife	\$19.60
APCO600	Right Deflector 3" Knife	\$21.65
APCO700	Left Deflector	\$15.45
APCO800	Left Rear End Shoe '95-up	\$26.80
APCO850	Left Rear End Shoe Pre '95	\$17.50
APCO900	Left Front End Shoe	\$14.40

Includes mounting hardware.

CASE IH 2142/2152/2162

Part #	Description	Price
APMD551	7 5/8" X 18 3/4" Case IH Skid	\$28.00
APMD188	12 1/2" x 18" LH Case IH Skid	\$48.00
APMD386	12 1/2" x 18" RH Case IH Skid	\$48.00
APMD208	16 1/4" x 16 3/8" Case IH SKid	\$47.00

ALSA included with Case 1020 Kits!

Improve the performance of your factory skid shoes with our Poly Last™ Stabilizer Covers. Simply remove the existing stabilizer cover and replace with the Poly Last™ cover. The best improvement you can make for under \$100.

The full size stabilizer cover is designed to prevent buildup where the competition falls short. It completely covers the A frame and provides one continuous shoe virtually eliminating areas where buildup and bunching occur. The front of the cover fastens to the top side of your metal skid shoes and the rear is suspended by chains. This allows the skid to float over the ground and provides easy access to the underside for routine inspection and maintenance. Each Case combine header kit comes with a full size stabilizer skid that covers the ENTIRE metal A frame under the end shoes.



ALSA...Left Stabilizer Cover...\$92.70 ARSA...Right Stabilizer Cover...\$80.35



Case IH 820 Flex Heads

U.S. Design Patent #314,778

The Case IH 820 skids come in Old (pre-'79) & New style. The two are identical except for the bend in the leading edge. Please use the diagram below to determine which style you have and specify when ordering.

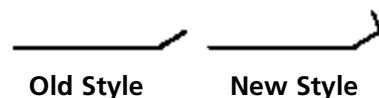

Part #	Description	Price
ASI2130	13' Case IH 820	\$490.00
ASI2150	15' Case IH 820	\$523.00
ASI2165	16 1/2' Case IH 820	\$530.00
ASI2175	17 1/2' Case IH 820	\$554.00
ASI2200	20' Case IH 820	\$592.00
ASI2225	22 1/2' Case IH 820	\$644.00

Kit includes: Poly Last covers, end skids, hardware & instructions.

Part #	Description	Price
API3275	32 3/4" Case IH 820 Panel	\$ 98.90
API2975	29 3/4" Case IH 820 Panel	\$ 90.65
API4100	41" Case IH 820 Panel	\$124.65
API5063	50 5/8" Case IH 820 Panel	\$153.50
API5663	56 5/8" Case IH 820 Panel	\$173.05
API4300	43" Case IH 820 Panel	\$131.85
API2213	22 1/8" Case IH 820 Panel	\$ 69.00
API3750	37 1/2" Case IH 820 Panel	\$114.35
API0575	5 3/4" Case IH 820 Panel	\$ 18.55
API1225	12 1/4" Case IH 820 Panel	\$ 38.10

Includes mounting hardware.

NEW HOLLAND POLY LAST™ COMBINE SKIDS

New Holland 971/972/973 Floating Head



The adjustable front and rear hinge allow for a custom "glove" fit on almost any head, new or used. Now you don't have to settle for one of those "me too" kits.

For heads with panels supported by chains. If panels are not supported by chains, Poly Skids will NOT fit.

Part #	Description	Price
ASN9130	13' New Holland	\$428.00
ASN9150	15' New Holland	\$492.00
ASN9160	16' New Holland	\$514.00
ASN9180	18' New Holland	\$586.00
ASN9200	20' New Holland	\$643.00
ASN9220	22' New Holland	\$701.00
ASN9240	24' New Holland	\$767.00
ASN9250	25' New Holland	\$787.00
ASN9300	30' New Holland	\$942.00

Kit includes: Poly Last™ covers, hardware, instructions & end shoes.

Part #	Description	Price
APN2300	23" New Holland Panel	\$ 80.00
APN2900	29" New Holland Panel	\$ 99.00
APN3500	35" New Holland Panel	\$118.00
AESN	New Holland End Skids Pair 5" x 14 1/4" & 7" x 29 3/4"	\$ 22.00

Replacement Panels include hardware.

New Holland 82C/83C/86C

Part #	Description	Price
APMD551	7 5/8" X 18 3/4" New Holland Skid	\$28.00
APMD188	12 1/2" x 18" LH New Holland Skid	\$48.00
APMD386	12 1/2" x 18" RH New Holland Skid	\$48.00
APMD208	16 1/4" x 16 3/8" New Holland Skid	\$47.00

New Holland 74C

Serial #'s PNL017183 to PNL017800

Part #	Description	Price
ASN71200	20' New Holland 74C	\$652.00
ASN71250	25' New Holland 74C	\$796.00
ASN71300	30' New Holland 74C	\$955.00

Serial #'s PNL017801 to PNL183000

Part #	Description	Price
ASN72200	20' New Holland 74C	\$618.00
ASN72250	25' New Holland 74C	\$737.00
ASN72300	30' New Holland 74C	\$869.00

DUAL DRIVE

Serial #'s PNL018301 and AFTER

Part #	Description	Price
ASN73200	20' New Holland 74C	\$ 615.00
ASN73250	25' New Holland 74C	\$ 737.00
ASN73300	30' New Holland 74C	\$ 870.00
ASN73350	35' New Holland 74C	\$1,019.00

SINGLE DRIVE

Serial #'s PNL018301 and AFTER

Part #	Description	Price
ASN73S200	20' New Holland 74C	\$615.00
ASN73S250	25' New Holland 74C	\$737.00

New Holland 740CF

Part #	Description	Price
ASN74200	20' New Holland 740CF	\$417.00
ASN74250	25' New Holland 740CF	\$504.00
ASN74300	30' New Holland 740CF	\$591.00
ASN74350	35' New Holland 740CF	\$678.00

Allis Chalmers Series III

Part #	Description	Price
ASA3130	13' ACIII Kit	\$374.00
ASA3150	15' ACIII Kit	\$445.00
ASA3160	16' ACIII Kit	\$459.00
ASA3180	18' ACIII Kit	\$507.00
ASA3200	20' ACIII Kit	\$556.00
ASA3220	22' ACIII Kit	\$620.00
ASA3240	24' ACIII Kit	\$652.00

Kit includes: Poly Last covers, end skids, hardware & instructions.



Made from our Grey Poly Last™ and designed with the help of custom combiners our skids will outwear the factory shoe as much as 3 to 1. Properly placed countersunk fasteners prevent soil from getting behind the skid extending service life. It's the longest lasting skid for your Mac Don. Guaranteed!

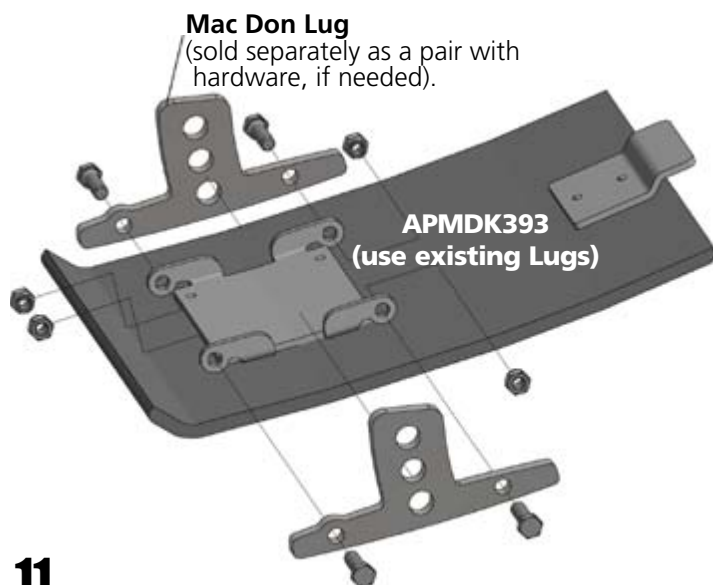

Please specify Old or New Style.
The Series III bend profile changed approx. 1987.

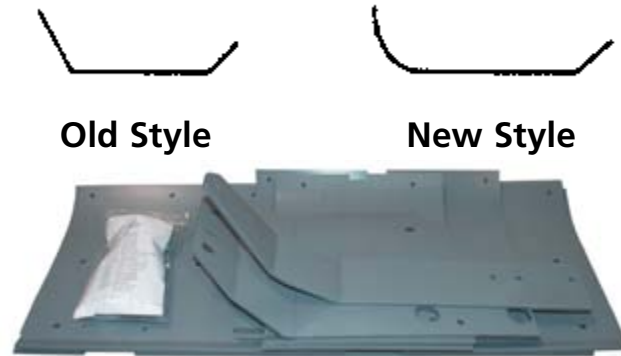

Mac Don D50, D60 & D70

Part #	Description	Price
APMD551	7 5/8" X 18 3/4" Mac Don Transition Pan Skid	\$28.00
APMD188	12 1/2" x 18" LH Mac Don End Skid	\$48.00
APMD386	12 1/2" x 18" RH Mac Don End Skid	\$48.00
APMD208	16 1/4" x 16 3/8" Mac Don Center Skid	\$47.00

Mac Don D65 & FD75

Part #	Description	Price
APMD551	7 5/8" X 18 3/4" Mac Don Transition Pan Skid	\$28.00
APMD188	12 1/2" x 18" LH Mac Don End Skid	\$48.00
APMD386	12 1/2" x 18" RH Mac Don End Skid	\$48.00

Mac Don D65 & FD75 Center Shoe

Part #	Description	Price
APMDK393	3/8" x 11 7/8" x 15 5/8" Mac Don Shoe Assembly Kit Replaces Molded Part #125393 and uses existing Lugs.	\$96.00
APMDP393	3/8" x 11 7/8" x 15 5/8" Mac Don Replacement Shoe - Poly Only	\$43.00
APMDPL393	Mac Don LUG Replacement With Hardware - not included in Kit	\$49.00/pr.



AGCO 500/800 Series Flex

Part #	Description	Price
ASA5150	15' AGCO 500/800 Kit	\$484.00
ASA5160	16' AGCO 500/800 Kit	\$525.00
ASA5180	18' AGCO 500/800 Kit	\$582.00
ASA5200	20' AGCO 500/800 Kit	\$613.00
ASA5220	22' AGCO 500/800 Kit	\$675.00
ASA5250	25' AGCO 500/800 Kit	\$742.00
ASA5300	30' AGCO 500/800 Kit	\$865.00

Kit includes: Grey Poly Last™ covers for panels, end skids, hardware, special hammer rivet tool and installation instructions.

ASK FOR GENUINE POLY LAST™ SKIDS

Poly Last™ kits are available at your local AGCO dealer. Should your dealer carry any brand other than Poly Last™, please contact Poly Tech and we will be sure you get genuine Poly Last™ skids.

Part #	Description	Price
APA57765	11 5/8" AGCO Panel	\$ 30.00
APA57380	17 5/8" AGCO Panel	\$ 45.00
APA57385	23 5/8" AGCO Panel	\$ 61.00
APA57386	23 5/8" AGCO Panel	\$ 61.00
APA57768	26 5/8" AGCO Panel	\$ 68.00
APA57771	26 5/8" AGCO Panel	\$ 68.00
APA57381	29 5/8" AGCO Panel	\$ 76.00
APA57382	29 5/8" AGCO Panel	\$ 76.00
APA57383	35 5/8" AGCO Panel	\$ 92.00
APA57384	35 5/8" AGCO Panel	\$ 92.00
APA50696	36 5/8" AGCO Panel	\$104.00
APA57376	36 13/16" AGCO Panel	\$123.00
APA57387	38 5/8" AGCO Panel	\$ 99.00
APA57388	38 5/8" AGCO Panel	\$ 99.00
APA56679	38 5/8" AGCO Panel	\$ 99.00
APA56678	38 5/8" AGCO Panel	\$ 99.00
APA51393	39 5/8" AGCO Panel	\$112.00
APA57377	39 13/16" AGCO Panel	\$131.00
APA56187	45 5/8" AGCO Panel	\$127.00
APA56188	45 13/16" AGCO Panel	\$146.00
APA51395	48 5/8" AGCO Panel	\$135.00
APA57759	48 13/16" AGCO Panel	\$153.00
APA50687	Right End Skid 3 1/2" x 24 9/16"	\$ 21.00
APA59326	Wobble Box Cover	\$ 36.00

Replacement panels include hardware.

Please have panel size and steel part number when ordering replacement panels.

AGCO 7200/8200 Series Flex

Part #	Description	Price
ASA6200	20' AGCO 7200/8200 Kit	\$630.00
ASA6250	25' AGCO 7200/8200 Kit	\$764.00
ASA6300	30' AGCO 7200/8200 Kit	\$890.00
ASA6350	35' AGCO 7200/8200 Kit	\$973.00

Kit includes: Grey Poly Last™ covers for panels, end skids, hardware, and installation instructions.

Part #	Description	Price
APA6159	17 5/8" AGCO Panel	\$ 53.77
APA6095	24 1/2" AGCO Panel	\$ 80.65
APA6096	24 1/2" AGCO Panel	\$ 80.65
APA6733	24 5/8" AGCO Panel	\$ 80.65
APA6229	29 15/16" AGCO Panel	\$ 80.65
APA6188	29 5/8" AGCO Panel	\$ 80.65
APA6154	35 5/8" AGCO Panel	\$ 107.77
APA6155	35 5/8" AGCO Panel	\$107.77
APA6626	35 5/8" AGCO Panel	\$107.77
APA6160	36 5/8" AGCO Panel	\$107.77
APA6156	35 5/8" AGCO Panel	\$107.77
APA6157	35 5/8" AGCO Panel	\$107.77
APA6161	38 5/8" AGCO Panel	\$107.77
APA6162	38 5/8" AGCO Panel	\$107.77
APA6627	38 5/8" AGCO Panel	\$107.77
APA6628	38 5/8" AGCO Panel	\$107.77
APA6187	41 15/16" AGCO Panel	\$121.10
APA6152	Wobble Box Cover (Left ES)	\$ 24.95
APA6153	Right End Skid	\$ 13.64
APA6369	Right End Divider	\$ 18.99
APA6370	Left End Divider	\$ 24.70

Replacement panels include hardware.

Please have panel size and steel part number when ordering replacement panels.

AGCO 9250 Dynaflex Draper

(May be an AGCO, Gleaner, Massey or Challenger header)

These kits fit ALL Low Profile Serial #'s and High Profile Serial #'s: AHD01101-CHD01100

Part #	Description	Price
ASA7250	25' AGCO 9250 Dynaflex Kit	\$ 764.00
ASA7300	30' AGCO 9250 Dynaflex Kit	\$ 890.00
ASA7350	35' AGCO 9250 Dynaflex Kit	\$ 973.00
ASA7400	40' AGCO 9250 Dynaflex Kit	\$1,045.00

These kits fit High Profile Serial #'s: CHD01101 and LATER

Part #	Description	Price
ASA8250	25' AGCO 9250 Dynaflex Kit	\$ 764.00
ASA8300	30' AGCO 9250 Dynaflex Kit	\$ 890.00
ASA8350	35' AGCO 9250 Dynaflex Kit	\$ 973.00
ASA8400	40' AGCO 9250 Dynaflex Kit	\$1,045.00

Kits include: Grey Poly Last™ covers for panels, end skids, hardware, and installation instructions.

Part #	Description	Price
APA7764	10 15/16" AGCO Panel	\$ 22.02
APA7959	11 5/8" AGCO Panel	\$ 22.02
APA8226	11 11/16" AGCO Panel	\$ 24.22
APA8227	11 11/16" AGCO Panel	\$ 24.22
APA7048	16 3/4" AGCO Panel	\$ 34.39
APA8262	16 3/4" AGCO Panel	\$ 34.39
APA7958	17 9/16" AGCO Panel	\$ 40.20
APA8225	17 9/16" AGCO Panel	\$ 40.20
APA7047	21" AGCO End Divider Fits Serial #AHD01101-CHD01100	\$ 27.66
APA8256	21 7/16" AGCO End Divider Fits Serial #CHD01101 and Later	\$ 27.66
APA7960	29 15/16" AGCO Panel	\$ 60.55
APA8255	29 15/16" AGCO Panel	\$ 60.55

Replacement panels include hardware.

White 900 Series

Because of changes in this series, we cannot determine the make-up of all head lengths. The 15', 16', 18' and 20' are available in kits. Please have size and number of panels for all others.

Part #	Description	Price
ASW2150	15' White 900 Kit	\$418.00
ASW2160	16' White 900 Kit	\$448.00
ASW2180	18' White 900 Kit	\$474.00
ASW2200	20' White 900 Kit	\$491.00
ASW2220	22' White 900 Kit	\$535.00
ASW2240	24' White 900 Kit	\$580.00

Kit includes: Poly Last™ covers, hardware & instructions. No end skids.

Part #	Description	Price
APW96000	5 1/4" x 6" Panel	\$12.40
APW91150	6" x 11 1/2" Panel	\$17.50
APW92575	10 1/2" x 25 3/4" Panel	\$60.75
APW92738	10 1/2" x 27 3/8" Panel	\$63.90
APW92975	10 1/2" x 29 3/4" Panel	\$71.10
APW93050	10 1/2" x 30 1/2" Panel	\$72.10
APW93200	10 1/2" x 32" Panel	\$76.20
APW93325	10 1/2" x 33 1/4" Panel	\$78.30
APW93600	10 1/2" x 36" Panel	\$85.50
APW93000	10 1/2" x 30" Panel	\$72.10
APW94100	10 1/2" x 41" Panel	\$98.90
APW91000	12" x 10" Panel	\$27.80

Replacement panels include hardware.

Massey 1859/9000 Flex Heads

Part #	Description	Price
ASM2130	13' Massey Kit	\$303.00
ASM2150	15' Massey Kit	\$340.00
ASM2160	16' Massey Kit	\$348.00
ASM2180	18' Massey Kit	\$365.00
ASM2200	20' Massey Kit	\$402.00
ASM2220	22' Massey Kit	\$426.00

Over 22' Order by Panel

Kit includes: Poly Last™ covers, hardware & instructions. No end skids.

Part #	Description	Price
APM1788	18" Massey Panel	\$41.20
APM3293	33" Massey Panel	\$74.20
APM4425	44 1/4" Massey Panel	\$97.85
ADSM LH	10 1/8" x 18 9/16" Left Hand Divider	\$43.25
ADSM RH	5 13/16" x 18 9/16" Right Hand Divider	\$29.90
ASCM	5 3/8" x 10 1/4" Snout Cover Pair	\$21.65

WHITE QUICK CUT

White Quick Cut is sold "By the Panel". There are two styles as illustrated. Give style and number of panels needed when ordering.

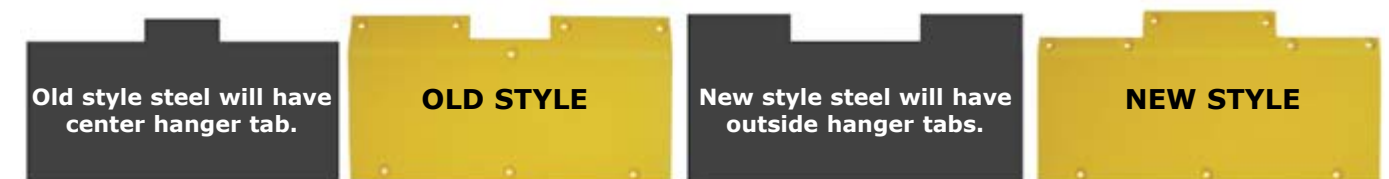

Old style steel will have center hanger tab.
Part # APWOS
9 1/2" x 17 7/8" Quick Cut Panel.....\$45.00

New style steel will have outside hanger tabs.
Part # APWNS
9 1/2" x 17 7/8" Quick Cut Panel.....\$45.00

POLY LAST™ FEEDER HOUSE KIT

POLY LAST™ AUGER BED LINER FOR CASE IH

Case IH Feeder House Silencer Kit - 2 Strand

All 1400 series are either High or Low. Please have serial number available. All other series are High serial number.

High Part #	Low Part #
1440 (Serial # 10,001 and up)	1440 (Serial # up to 10,000)
1460 (Serial # 12,001 and up)	1460 (Serial # up to 12,000)
1480 (Serial # 14,001 and up)	1480 (Serial # up to 14,000)

Part # for High Serial #	Part # for Low Serial #	Description	Price
AMW81750	AMW81742	1480, 1680, 1688, 2188, 2388 - 60"	\$555.00
AMW82069	AMW82069	2144, 2166, 2344, 2366 - 60"	\$555.00
AMW81751	AMW81743	1420, 1440, 1460, 1620, 1640, 1660, 1666, 2144, 2166, 2344, 2366, - 54"	\$515.00
AMW81752	AMW81744	1480, 1680, 1688, 2188, 2388, - 54"	\$515.00
AMW81753	AMW81745	1420, 1440, 1460, 1620, 1640, 1660 - 47"	\$515.00

Case IH Feeder House Silencer Kit - 3 Strand

Part #	Description	Price
AMW82071	3 Strand Kit - 54"	\$587.00
AMW82072	3 Strand Kit - 60"	\$630.00



Throat Liner: Poly Last™ floor improves feeding of crop and reduces noise created by metal on metal contact.

Drum Guards: Soft plastic, rubber like material covers the metal drum in chain area. Saves the chain from excessive wear on the drum and reduces noise.

Rails: Poly Last™ covers for existing metal rails. Helps prevent clattering of metal on metal as the bars on the feeder house chain hit the rails. Reduces wear on rails and bars. Reduces Noise.

Top Sprocket Stripper Plates: Replaces metal stripper plates with Poly Last™. Prevents chain wear normally associated with grooved metal plate and reduces metal to metal noise.

Reduce Feeder House Noise and Improve Crop Flow!

Part #	Description	Price
THROAT LINER		
AMW40596	1480, 1680, 1688, 2188, 2388 - 60"	\$405.00
AMW41088	2144, 2166, 2344, 2366 - 60"	\$405.00
AMW40597	1480, 1680, 1688, 2188, 2388 - 54"	\$373.00
AMW40598	1420, 1440, 1460, 1620, 1640, 1660, 2144, 2166, 2344, 2366 - 54"	\$363.00
AMW40599	1420, 1440, 1460, 1620, 1640, 1660 - 47"	\$363.00
DRUM GUARD		
AMW40005	Rock or Smooth drum guards - pair	\$ 83.00
AMW40918	3 strand Drum Guard Assembly	\$126.00
AMW41030	4" x 31" Drum Guard - undrilled pair	\$ 88.00
RAIL GUIDE		
FHRCK001	Rail Guide Kit	\$ 38.00
TOP SPROCKET STRIPPER PLATE		
AMW40009	Top Sprocket Stripper Plate 4.5" x 8" pr. 1440 (Serial # up to 10,000) 1460 (Serial # up to 12,000) 1480 (Serial # up to 14,000)	\$ 65.00
AMW40010	Top Sprocket Stripper Plate 7.2" x 6.5" pr. 1440 (Serial # 10,001 & up), 1640 1460 (Serial # 12,001 & up), 1660 1480 (Serial # 14,001 & up), 1680 2144, 2166, 2188, 2344, 2366, 2388	\$ 65.00
AMW40674	Top Sprocket Stripper Plate middle 6 1/8" x 6 5/8" ea.	\$ 34.00
SPCP8011	Stripper Plate 4" x 6 5/8" ea. 2588, 5088, 7088, 5130, 6130 & 7130 <i>Replaces Case IH # 87748011 (3 parts required on all models)</i>	\$ 34.00



FOR CASE 1400, 1600, 2100 & 2300 SERIES COMBINES

- Improve crop flow.
- Repair worn and corroded auger beds.
- Prevent future wear and corrosion.

DON'T PUT GRAIN ON THE GROUND

Buy Our Liners...

Holes develop in the bottom of your trough due to wear or more often due to corrosion. When holes develop, the grain drops straight to the ground under the combine. Why spend over \$1,200.00 on a replacement trough that is extremely difficult to remove and re-install?

Our Poly Last™ liners install much easier, offer excellent corrosion resistance, feed better, and are a far better solution than a patch or repair.



Part #	Description	Price
ABCK4060	4 Auger Kit Fits Combine Models: 1440, 1460, 1470, 1640, 1644, 1660, 1666, 2144, 2166, 2344, 2366	\$518.00
ABCK80	5 Auger Kit Fits Combine Models: 1480, 1482, 1680, 1682, 1688, 2188, 2377, 2388, 2577, 2588	\$633.00
ABCK11	Single Inside Trough Kit	\$128.00
ABCK15	Single Outer Trough Kit	\$139.00

POLY LAST™ AUGER BED LINER FOR JOHN DEERE



Part #	Description	Price
ABJK071	4 Auger Kit Fits Combine Models: 9650STS, 9660STS, 9750STS, 9760STS, 9860STS, 9880STS	\$433.00
ABJK1138	SINGLE Auger Kit Fits Combine Models: 9650STS, 9660STS, 9750STS, 9760STS, 9860STS, 9880STS	\$112.00

POLY LAST™ FEED PLATE FOR CASE IH

- Replaces factory steel feed plates.
- Quick, easy installation using factory clips.
- Improves crop flow in all conditions.
- Over 50% lighter than OEM panels.

Stainless steel hardware and connectors for greater durability.

Center sections reinforced with stainless angle for greater rigidity.

Front clip molded in 18" segments for greater flexibility.



Part #	Description	Price
FPCK2150	Case 1020 Feed Plate - 15'	\$832.00
FPCK2165	Case 1020 Feed Plate - 16 1/2'	\$894.00
FPCK2175	Case 1020 Feed Plate - 17 1/2'	\$924.00
FPCK2200	Case 1020 Feed Plate - 20'	\$1029.00
FPCK2225	Case 1020 Feed Plate - 22 1/2'	\$1067.00
FPCK2250	Case 1020 Feed Plate - 25'	\$1147.00
FPCK2300	Case 1020 Feed Plate - 30'	\$1307.00

Oversize Shipping Charge - Regular Shipping + \$50.00.

GRAIN GRABBER 2



- Allows reel to be run higher for Less Shatter.
- Reduces Slugging.
- Allows you to run longer at night.

For pennies on the dollar, you can make your auger perform like a full-finger auger. With one Grain Grabber between each flight, you can run your reel higher and out of the crop which means less shattering. Your grain will feed more evenly with our Grain Grabber, reduce slugging and allow you to run longer at night. Each Grain Grabber comes with its own hardware.

REVISED APPLICATION RECOMMENDATION

A small percentage of farmers are experiencing issues toward the center of the auger when using the Grain Grabber. The aggressive nature of the Grain Grabber and the build up of crop volume at the center of the auger can cause crop to be thrown out of the center of the header. The Grain Grabbers at the ends of the auger are doing a great job. If you expect a heavy crop you may want to reduce the number of Grain Grabbers at the center of your header.

Part #	Description	Price
ARGG201	Grain Grabber 2 - Black	\$30.00 ea.
Length	Recommended	Price
30'	10 ea. Grain Grabber 2, Bolts, Drill Bit	\$300.00
25'	8 ea. Grain Grabber 2, Bolts, Drill Bit	\$240.00
20'	6 ea. Grain Grabber 2, Bolts, Drill Bit	\$180.00
18' or Less	4 ea. Grain Grabber 2, Bolts, Drill Bit	\$120.00

TRU TUBE TOOL

Step by Step Auger Repair



Part #	Description	Price
TT16	Fits 16" Augers Including John Deere & Gleaner	\$47.00
TT14	Fits 14" Augers Including Case IH	\$47.00
TT12	Fits 12" Augers	\$47.00

PIPE REEL TINES



Part #	Description	Price
P153175	Poly finger for cutting platforms; 4 1/2" Tine Spacing; Fits Agco Gleaner 300, 400, 500, 700, 800 Case IH 1010, 1020; John Deere 900 Prior to S/N 685100; Massey 9700, 9750; New Holland 971, 973	\$1.99
P153176	Poly finger for cutting platforms; 6" Tine Spacing; Fits Agco Gleaner 700, 800, 7000, 8000, 8200; Case IH 1010, 1020 (2001 & Up), 2010, 2020; Cat F; Lexicon F, Challenger Flex Headers; John Deere 900F & R (S/N 685101 & Up), 600F, 600R; Massey 8000, 8200, 9800, 9850; New Holland 71C, 72C, 73C, & 74C	\$2.25

Replace the original metal fingers in combine augers. Broken metal fingers can do thousands of dollars of damage to rotors and cylinders. A bent metal finger can cut an auger in half before you have time to shut it down. Poly fingers bend 10° past the breaking point of metal before breaking. When poly fingers do break and pass through the combine they don't damage internal parts.

CASE IH 1010/1020/2162/2152/2142 NH 86C/83C/82C MAC DON CA20/CA25

Part #	Description	Price
AMW81369	Case Poly Finger 100 Pack	\$902.00
AMW81369-1	NH Poly Finger 100 Pack	\$902.00
AMW81369-2	Mac Don Poly Finger 100 Pack	\$902.00
AMW81988	Case Poly Finger 24 Pack	\$221.00
AMW81988-1	NH Poly Finger 24 Pack	\$221.00
AMW81988-2	Mac Don Poly Finger 24 Pack	\$221.00
AMW80645	Case Poly Finger 12 Pack Kit	\$145.00
AMW80645-1	NH Poly Finger 12 Pack Kit	\$145.00
AMW80645-2	Mac Don Poly Finger 12 Pack Kit	\$145.00
AMW80646	Case Single Poly Finger Kit	\$ 12.50
AMW80646-1	NH Single Poly Finger Kit	\$ 12.50
AMW80646-2	Mac Don Single Poly Finger Kit	\$ 12.50
AMW40601	Case Single Poly Finger	\$ 9.50
AMW40601-1	NH Single Poly Finger	\$ 9.50
AMW40601-2	Mac Don Single Poly Finger	\$ 9.50

CASE IH 2020/NH 74C

Part #	Description	Price
AMW82484	Case Poly Finger 100 Pack	\$902.00
AMW82484-1	NH Poly Finger 100 Pack	\$902.00
AMW82483	Case Poly Finger 24 Pack	\$221.00
AMW82483-1	NH Poly Finger 24 Pack	\$221.00
AMW82482	Case Poly Finger 12 Pack Kit	\$145.00
AMW82482-1	NH Poly Finger 12 Pack Kit	\$145.00
AMW82481	Case Single Poly Finger Kit	\$ 12.50
AMW82481-1	NH Single Poly Finger Kit	\$ 12.50
AMW41488	Case Single Poly Finger	\$ 9.50
AMW41488-1	NH Single Poly Finger	\$ 9.50

"Kits" include finger, guide and hardware.
You MUST replace guides when switching from metal to poly fingers.

CASE IH 2062/2052/2042 NH 84C MAC DON 872/873 with 11" AUGER DRUM

Part #	Description	Price
AMW82618	Case Poly Finger 100 Pack	\$902.00
AMW82618-1	NH Poly Finger 100 Pack	\$902.00
AMW82618-2	Mac Don Poly Finger 100 Pack	\$902.00
AMW82617	Case Poly Finger 24 Pack	\$221.00
AMW82617-1	NH Poly Finger 24 Pack	\$221.00
AMW82617-2	Mac Don Poly Finger 24 Pack	\$221.00
AMW82616	Case Poly Finger 12 Pack Kit	\$145.00
AMW82616-1	NH Poly Finger 12 Pack Kit	\$145.00
AMW82616-2	Mac Don Poly Finger 12 Pack Kit	\$145.00
AMW82615	Case Single Poly Finger Kit	\$ 12.50
AMW82615-1	NH Single Poly Finger Kit	\$ 12.50
AMW82615-2	Mac Don Single Poly Finger Kit	\$ 12.50
AMW41586	Case Single Poly Finger	\$ 9.50
AMW41586-1	NH Single Poly Finger Kit	\$ 9.50
AMW41586-2	Mac Don Single Poly Finger Kit	\$ 9.50

MAC DON with 12" AUGER DRUM

Part #	Description	Price
AMW83379	Poly Finger 100 Pack	\$902.00
AMW83380	Poly Finger 24 Pack	\$221.00
AMW83381	Poly Finger 12 Pack Kit	\$145.00
AMW83382	Single Poly Finger Kit	\$ 12.50
AMW41997	Single Poly Finger	\$ 9.50

CASE IH 3020/3016/3162/3152 NH 740CF/760CG/790CP/880CF/840CD

Part #	Description	Price
AMW82128	Case Poly Finger 100 Pack	\$902.00
AMW82128-1	NH Poly Finger 100 Pack	\$902.00
AMW82129	Case Poly Finger 24 Pack	\$221.00
AMW82129-1	NH Poly Finger 24 Pack	\$221.00
AMW82130	Case Poly Finger 12 Pack Kit	\$145.00
AMW82130-1	NH Poly Finger 12 Pack Kit	\$145.00
AMW82131	Case Single Poly Finger Kit	\$ 12.50
AMW82131-1	NH Single Poly Finger Kit	\$ 12.50
AMW41967	Case Single Poly Finger	\$ 9.50
AMW41967-1	NH Single Poly Finger	\$ 9.50

NEW HOLLAND 973/972/971

Part #	Description	Price
AMW81367	Poly Finger 100 Pack	\$902.00
AMW81364	Poly Finger 24 Pack	\$221.00
AMW81935	Poly Finger 12 Pack Kit	\$145.00
AMW81366	Single Poly Finger Kit	\$ 12.50
AMW40822	Single Poly Finger	\$ 9.50

JOHN DEERE 200/900

Part #	Description	Price
AMW81363	Poly Finger 100 Pack	\$902.00
AMW81990	Poly Finger 24 Pack	\$221.00
AMW80649	Poly Finger 12 Pack Kit	\$145.00
AMW80650	Single Poly Finger Kit	\$ 12.50
AMW40600	Single Poly Finger	\$ 9.50

JOHN DEERE 600F/600R/600P

Part #	Description	Price
AMW82478	Poly Finger 100 pack	\$902.00
AMW82477	Poly Finger 24 pack	\$221.00
AMW82476	Poly Finger 12 pack Kit	\$145.00
AMW82475	Single Poly Finger Kit	\$ 12.50
AMW41489	Single Poly Finger	\$ 9.50

JOHN DEERE 600FD/600D

Part #	Description	Price
AMW83524	Poly Finger 100 Pack	\$902.00
AMW83525	Poly Finger 24 Pack	\$221.00
AMW83526	Poly Finger 12 Pack Kit	\$145.00
AMW83527	Single Poly Finger Kit	\$ 12.50
AMW42107	Single Poly Finger - each	\$ 9.50

"Kits" include finger, guide and hardware.
You MUST replace guides when switching from metal to poly fingers.

AGCO with METAL ADAPTER (threaded)

Part #	Description	Price
AMW82623	Poly Finger 100 Pack	\$902.00
AMW82622	Poly Finger 24 Pack	\$221.00
AMW82621	Poly Finger 12 Pack Kit	\$145.00
AMW82620	Single Poly Finger Kit	\$ 12.50
AMW42235	Single Poly Finger	\$ 9.50

AGCO with POLY ADAPTER

Part #	Description	Price
AMW82623	Poly Finger 100 Pack	\$902.00
AMW82622	Poly Finger 24 Pack	\$221.00
AMW83440	Poly Finger 12 Pack Kit	\$145.00
AMW83439	Single Poly Finger Kit	\$ 12.50
AMW42235	Single Poly Finger	\$ 9.50

MISCELLANEOUS PARTS

Part #	Description	Price
K-P179000	Universal Guide (Does not fit AGCO or JD600) 2 5/8" from hole ctr to hole ctr.	\$3.25
AMW22407	Case & NH Molded Guide 2 5/16" from hole ctr. to hole ctr.	\$3.25
AMW21018	John Deere 600 Guide	\$3.25
AMW22174	AGCO Guide	\$3.25
AMW40603	Guide Screw (self threading) - pr.	\$1.00
AMW42200	Case/NH Guide Kit w/Hardware	\$4.75
AMW40274	NH 973/972/971 Guide Kit w/Hardware	\$4.25
AMW40685	JD 200/900 Finger Hardware Kit	\$3.00
AMW40603	JD 600F/600R/600P & JD 200/900 Guide Kit w/Hardware	\$4.25
AMW42116	JD 600FD/600D Guide Kit w/Hardware	\$4.25
AMW41602	AGCO Adapter Clip Kit for threaded metal adapter	\$9.00
AMW41998	AGCO Adapter Clip Kit for poly adapter	\$6.00
AMW22132	AGCO Threaded metal adapter	\$8.00
AMW22776	AGCO Plastic adapter	\$5.00
AMW00957	AGCO Clip Only	\$1.50

PROTECT YOUR GRAIN TANK FROM CORROSION AND WEAR.

The Poly Last™ Auger Liner for grain tanks covers the existing auger floor, no matter what condition it is in and provides a slippery surface to keep grain feeding into the unloading auger faster. Poly Last™ does not rust or corrode.

- Stainless steel strips CNC cut for precise fit, allowing for accurate and quick positioning of hold down strips.
- Poly liner "floats" under stainless strips allowing the poly to expand & contract without buckling.
- 1/8" flexible UHMW poly is preformed to fit tightly against the grain tank floor.
- Complete kit is quick & easy to install.
- Installs without removing augers. No welding.
- Replace only the auger liner with Poly Last™, not the entire floor.



GRAIN TANK AUGER FLOOR LINER

JOHN DEERE SERIES

Part #	Description	Price
AGTJK001	Fits John Deere 9400 / 9500 / 9510 combines	\$432.00
AGTJK002	Fits John Deere 9550 combines	\$432.00
AGTJK003	Fits John Deere 9600 / 9610 combines	\$452.00
AGTJK004	Fits John Deere 9570STS / 9650STS / 9660STS / 9750STS combines	\$452.00
AGTJK005	Fits John Deere High Unload Rate combines 9660STS / 9670STS / 9760STS with HUR option / 9770STS / 9860STS / 9870STS / S660 with HUR up to serial #765000 / All S660 after serial #765001 / S670 / S680 / S690 combines	\$464.00
AGTJK006	Fits John Deere 9650 / 9660 Walker combines	\$465.00

NEW HOLLAND

Part #	Description	Price
AGTNK001*	Fits New Holland CR920, CR940, CR960, CR970, CR980, CR8090 CR9040, CR9060, CR9065, CR9070 & CR9080 combines	\$476.00
AGTN086	Fits New Holland TR86 combines	\$312.00
AGTN097*	Fits New Holland TR96, TR97, TR98 & TR99 combines	\$327.00

*** Oversized Kit - Regular Shipping + \$50.00.**

Kit includes: poly, stainless hold downs, hardware & instructions.

*Auger needs to be removed for installation of New Holland kits.

CASE SERIES

Part #	Description	Price
AGTC001	1600 All except 1620 2100 All, 2300 All, 2588 All	\$432.00
AGTC002	5088, 6088 & 7088	\$468.00
*AGTC003	7010, 7120, 8010, 8120 & 9120	\$476.00
*AGTC004	7230, 8230 & 9230	\$468.00
AGTC014	1400 All	\$432.00
AGTC001U	Upper Auger Trough 1600 - 2588	\$221.00
AGTC001L	Lower Auger Trough 1600 - 2588	\$221.00
*AGTC004F	Front Trough Kit 7230, 8230 & 9230	\$239.00
*AGTC004R	Rear Trough Kit 7230, 8230 & 9230	\$239.00
AGTC014U	Upper Auger Trough 1400	\$221.00
AGTC014L	Lower Auger Trough 1400	\$221.00
AGTCP001	1/8" x 9 3/4" x 86 1/4" Red Poly Liner	\$125.00
AGTCHD001	5 Piece Stainless Hold Down Strip Kit	\$242.00

***Oversized Kit - Regular shipping + \$50.00**

Kit includes: Poly Last flooring and stainless steel hold downs.

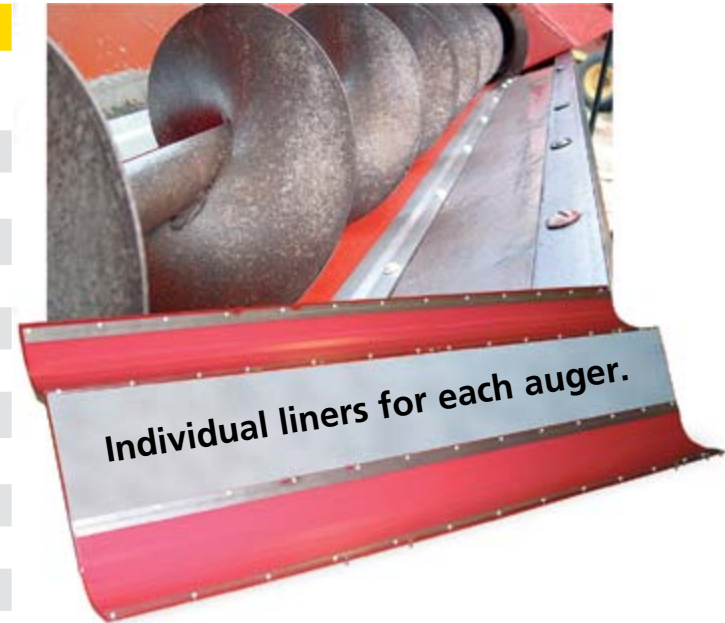

UNIVERSAL KIT

Part #	Description	Price
AGTU001	Universal Auger Trough Liner Kit	\$220.00
INCLUDES:		
<ul style="list-style-type: none"> • 1 each 1/8" x 13" x 97 5/8" Preformed Poly Last Liner • 2 each 1 1/2" x 97 5/8" Stainless hold down strip • 32 each Self drilling screws • 32 each 3/16" x 1/4" Steel pop rivet • 1 each 13/64" Drill Bit • 1 each Tube Silicone • 1 each Instruction sheet 		
AGTU002	Universal Auger Trough Liner 1/2 Kit	\$146.00
INCLUDES:		
<ul style="list-style-type: none"> • 1 each 1/8" x 13" x 48" Preformed Poly Last Liner • 2 each 1 1/2" x 48" Stainless hold down strip • 16 each Self drilling screws • 16 each 3/16" x 1/4" Steel pop rivet • 1 each 13/64" Drill Bit • 1 each Tube Silicone • 1 each Instruction sheet 		
AGTUHD97	Universal Grain Tank 97" Hold Down Kit	\$129.00
AGTUHD002	Universal Grain Tank 48" Hold Down Kit	\$ 64.00

AGCO/GLEANER SERIES

Part #	Description	Price
*AGTGK001	Fits Model R52 Combines	\$290.00
AGTGK002	Fits Models R62 & R65 Combines	\$359.00

***Oversized Kit - Regular shipping + \$50.00**

Kit includes: poly, stainless hold downs, hardware instructions.

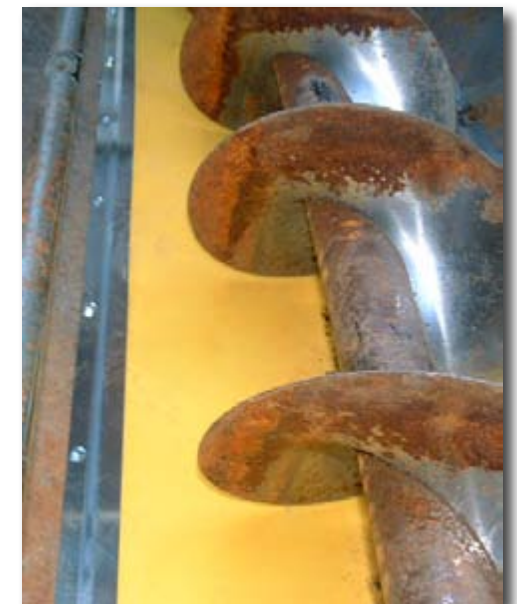

AUGER TROUGH REPAIR FOR GRAIN HEADS

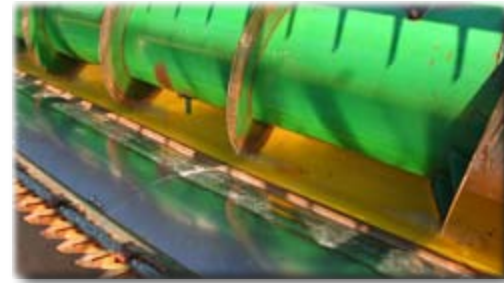

- Install over worn metal.
- Covers full length of trough.
- Tough Slippery 1/4" Poly Last™.
- Improves crop flow in all conditions.

JOHN DEERE GRAIN PLATFORM AUGER TROUGH LINERS - FLEX HEADS

Part #	Description	Price
For 900 Series Flex Headers		
* Please Specify throat opening size of 46" or 58" when ordering.		
GPJK930	Auger trough Liner fits John Deere 930 & 930F Flex headers	\$759.00
GPJK925	Auger trough Liner fits John Deere 925 & 925F Flex headers	\$658.00
GPJK924	Auger trough Liner fits John Deere 924 & 924F Flex headers	\$637.00
GPJK922	Auger trough Liner fits John Deere 922 & 922F Flex headers	\$589.00
GPJK920	Auger trough Liner fits John Deere 920 & 920F Flex headers	\$520.00
GPJK918	Auger trough Liner fits John Deere 918 & 918F Flex headers	\$487.00
GPJK915	Auger trough Liner fits John Deere 915 & 915F Flex headers	\$433.00
For 200 Series Flex Headers		
GPJK230	Auger trough Liner fits John Deere 230 Flex header	\$783.00
GPJK224	Auger trough Liner fits John Deere 224 Flex header	\$647.00
GPJK220	Auger trough Liner fits John Deere 220 Flex header	\$562.00
GPJK218	Auger trough Liner fits John Deere 218 Flex header	\$531.00
GPJK216	Auger trough Liner fits John Deere 216 Flex header	\$502.00
GPJK215	Auger trough Liner fits John Deere 215 Flex header	\$486.00
GPJK213	Auger trough Liner fits John Deere 213 Flex header	\$456.00
For 600 Series Flex Headers		
GPJK635	Auger trough Liner fits John Deere 635 Flex header	\$891.00
GPJK630	Auger trough Liner fits John Deere 630 Flex header	\$819.00
GPJK625	Auger trough Liner fits John Deere 625 Flex header	\$708.00
GPJK622	Auger trough Liner fits John Deere 622 Flex header	\$621.00
GPJK620	Auger trough Liner fits John Deere 620 Flex header	\$570.00
GPJK618	Auger trough Liner fits John Deere 618 Flex header	\$555.00

These kits require 5/8" x 1" Floor Stripper for proper installation.

* For 900 Series: Please specify throat opening size of 46" or 58" when ordering. (Distance between stripper plates at throat)

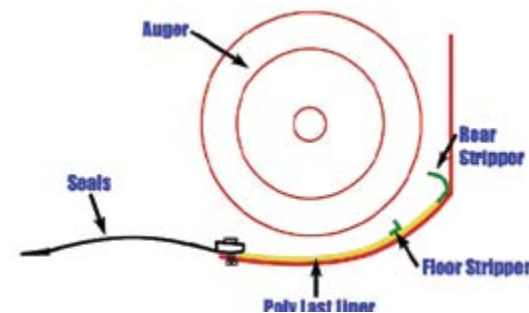

John Deere Liner Detail

AUGER TROUGH REPAIR FOR GRAIN HEADS

JOHN DEERE GRAIN PLATFORM AUGER TROUGH LINERS - RIGID HEADS

* Cutter bar position is needed to order - To determine cutter bar position, measure from the front of the rear stripper to the back of the cutter bar. - If cutter bar is not in the standard position, additional shipping time may be required.

For 900 Series Rigid Headers - (Oversize Shipping Charge - Regular Shipping + \$50.00.)

Part #	Description	Price
GPJRK92446	Fits John Deere 924 Rigid header - 46" opening	\$1,245.00
GPJRK92458	Fits John Deere 924 Rigid header - 58" opening	\$1,245.00
GPJRK92546	Fits John Deere 925 Rigid header - 46" opening	\$1,260.00
GPJRK92558	Fits John Deere 925 Rigid header - 58" opening	\$1,260.00
GPJRK93046	Fits John Deere 930 Rigid header - 46" opening	\$1,494.00
GPJRK93058	Fits John Deere 930 Rigid header - 58" opening	\$1,494.00
GPJRK92446G	Fits John Deere 924 Rigid header - 46" opening - Green	\$1,145.00
GPJRK92458G	Fits John Deere 924 Rigid header - 58" opening - Green	\$1,145.00
GPJRK92546G	Fits John Deere 925 Rigid header - 46" opening - Green	\$1,160.00
GPJRK92558G	Fits John Deere 925 Rigid header - 58" opening - Green	\$1,160.00
GPJRK93046G	Fits John Deere 930 Rigid header - 46" opening - Green	\$1,391.00
GPJRK93058G	Fits John Deere 930 Rigid header - 58" opening - Green	\$1,391.00

CASE IH GRAIN PLATFORM AUGER TROUGH LINERS

Part #	Description	Price
GPCK10300	Auger trough Liner fits Case IH 1020 30' header	\$689.00
GPCK10250	Auger trough Liner fits Case IH 1020 25' header	\$582.00
GPCK10225	Auger trough Liner fits Case IH 1020 22.5' header	\$530.00
GPCK10200	Auger trough Liner fits Case IH 1020 20' header	\$477.00
GPCK10175	Auger trough Liner fits Case IH 1020 17.5' header	\$424.00
GPCK10165	Auger trough Liner fits Case IH 1020 16.5' header	\$416.00
GPCK10150	Auger trough Liner fits Case IH 1020 15' header	\$393.00

NEW HOLLAND GRAIN PLATFORM AUGER TROUGH LINERS

Part #	Description	Price
GPNK9730	Auger trough Liner fits New Holland 972 & 973 30' header	\$743.00
GPNK9725	Auger trough Liner fits New Holland 972 & 973 25' header	\$644.00
GPNK9724	Auger trough Liner fits New Holland 972 & 973 24' header	\$628.00
GPNK9722	Auger trough Liner fits New Holland 972 & 973 22' header	\$567.00
GPNK9720	Auger trough Liner fits New Holland 972 & 973 20' header	\$525.00
GPNK9716	Auger trough Liner fits New Holland 972 & 973 16' header	\$451.00



POLY LAST™ FEED PLATE COVER

JD 200/900 SERIES

Part #	Description	Price
AFPJ2130	13' Deere 200/900 Kit	\$285.00
AFPJ2150	15' Deere 200/900 Kit	\$329.00
AFPJ2160	16' Deere 200/900 Kit	\$352.00
AFPJ2180	18' Deere 200/900 Kit	\$397.00
AFPJ2200	20' Deere 200/900 Kit	\$441.00
AFPJ2220	22' Deere 200/900 Kit	\$490.00
AFPJ2240	24' Deere 200/900 Kit	\$531.00
AFPJ2250	25' Deere 200/900 Kit	\$555.00
AFPJ2300	30' Deere 200/900 Kit	\$664.00

CASE IH 820

Part #	Description	Price
AFPI2130	13' Case IH 820 Kit	\$212.00
AFPI2150	15' Case IH 820 Kit	\$245.00
AFPI2165	16 1/2' Case IH 820 Kit	\$267.00
AFPI2175	17 1/2' Case IH 820 Kit	\$285.00
AFPI2200	20' Case IH 820 Kit	\$333.00
AFPI2225	22 1/2' Case IH 820 Kit	\$368.00

Kit includes: 1/8" Yellow Poly Last™ covers, hardware & instructions. Ships UPS in 4 to 6 sections depending on length of head. Each section is formed to fit and rivets over your existing steel feed plate. Kit for John Deere also includes an "L" shape strip which mounts just behind the cutter bar and helps prevent crop loss at the front of your header.

ROW CROP AUGER TROUGH LINER

Made from full 1/4" UV Protected Poly Last™ UHMW

JOHN DEERE 50 SERIES

Part #	Description	Price
GPJRCK853A	Auger Trough Liner fits John Deere 853A Row Crop Head	\$575.00
GPJRCK653A	Auger Trough Liner fits John Deere 653A Row Crop Head	\$469.00
GPJRCK654A	Auger Trough Liner fits John Deere 654A Row Crop Head	\$542.00

Oversize Shipping Charge on these kits
Regular Shipping + \$50.00.

- Installs quickly and easily.
- Restores auger trough to "better than new" condition.
- Improves crop flow from the first acre to the last, year after year...

POLY LAST™ ROW CROP SKIDS

Part #	Description	Price
ARCJ1800	John Deere 50 Series	\$40.00/pair
ARCJ2125	John Deere 50A Series (original 5 hole pattern)	\$44.00/pair
ARCJ2125P	John Deere 50A Series (factory punched 4 hole pattern)	\$44.00/pair



Kit Includes: Yellow Poly Last™ skid shoes, hardware & instructions.

Some products are just more
"dependable" than others.



Dependable: de pend a ble [di-pen-duh-buhl] adj.
 1. worthy of reliance or trust; "a reliable source of information" "a dependable worker" [syn: reliable]
 2. worthy of being depended on; "a dependable worker"; "an honest working stiff"; "a reliable source of information"; "he was true to his word"; "I would be true for there are those who trust me"
 3. consistent in performance or behavior; "dependable in one's habits"; "a steady-going family man"
 4. financially sound; "a good investment"; "a secure investment"

For over 40 years, Poly Tech has proudly served you with the quality products and outstanding customer service that you demand. When quality counts you can count on Poly Tech.

1975 - Poly Tech was founded as a Christian company on the premise that God is chairman of the board. That premise still holds true as Poly Tech enters its' second generation as a family owned and operated business. Today, two generations of family work together as we continue to serve the agricultural industry with those same core beliefs and values.

1988 - Poly Tech patents the first combine skid cover. Then in 1992 patents the "Living Hinge" design used on tens of thousands of John Deere 900 series combines. Today, Poly Tech manufactures a full line of products including corn head liners, grain tank liners, grain head & auger bed trough liners and more.

2010 - Poly Tech files for a patent on its innovative new Poly Last™ Tube Liner. This pre-assembled unit can be installed without removing the auger in most cases, self adjusts to uneven tube diameters and can cost as little as half of a replacement or repair. Our commitment to innovative, cost saving new products is stronger today than it's ever been.

2016 - Poly Tech invites you to join us for many more years of innovation. If you have a problem that needs solving we'd love to hear about it. Helping you save time and money has been the core of our business. So, stop by our booth at a trade show, call us, email us or write us.

You can "DEPEND" on Poly Tech, We Guarantee It.



Poly Tech Industries
1.800.542.7659
P.O. Drawer 349
Monticello, GA 31064

polyskid.com

Helping you work smarter, harder and better!

Made of UHMW preformed poly, these auger wear shoes are designed to extend the life of the steel auger by covering new or worn steel auger flighting giving it strength and avoiding wear. There are over 300 sizes available. The wear shoes are available in different diameters, pitches and thickness (most common 3/8") to fit most common augers. Some applications include combines, grain carts, transport augers, bins and grain handling systems; wherever high volume and wear are a problem.



Description	Bolts Req'd per pitch	Price per Pitch
6" Diameter	3	\$24.50
7" Diameter	3	\$28.25
8" Diameter	3	\$32.50
9" Diameter	3 to 4	\$37.25
10" Diameter	3 to 4	\$42.75
11" Diameter	4	\$45.75
12" Diameter	4	\$49.00
13" Diameter	4	\$52.50
14" Diameter	4	\$56.00
15" Diameter	5	\$60.00
16" Diameter	5	\$64.25
17" Diameter	5	\$68.75
18" Diameter	5	\$73.50
19" Diameter	5	\$78.50
20" Diameter	5	\$84.00
21" Diameter	5	\$89.75
22" Diameter	5 to 6	\$96.25
23" Diameter	5 to 6	\$103.00
24" Diameter	6	\$110.25
1/4" x 1" Poly capped bolts (#ALAWSH01)	(net no discounts)	\$1.00
1/4" x 1 1/2" Poly capped bolts (#ALAWSH)	(net no discounts)	\$1.00
1/4-20 x 1 Stainless Steel Hex Bolt (#AH1305)	(net no discounts)	\$.20

INFORMATION WE NEED TO TAKE AN ORDER

Brand and Model number of machinery: _____

A – Outside diameter of the flighting: _____
(not outside tube diameter)

B – Flighting width: _____

C – Outside diameter of the center pipe: _____

D – Pitch - distance between the auger spirals: _____
(be sure to measure parallel to the center pipe)

Has auger been replaced or re-flighted: _____

E – Left hand or right hand: _____

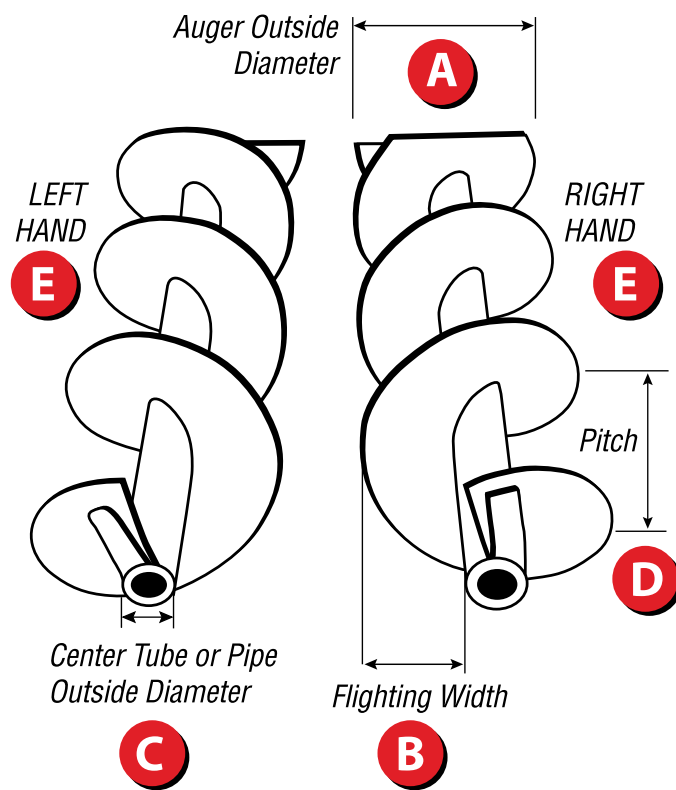

All wear shoes include hardware for installation.

Available 3/8" thick or 1/4" thick Poly Last™

SEE NEXT PAGE FOR A LIST OF "IN STOCK" AUGER WEAR SHOES.

AUGER WEAR SHOES COVERED BY ORIGINAL MANUFACTURER'S WARRANTY

UHMW WEARSHOES IN STOCK!

Same/Next Day Shipping on these Popular Sizes

Part #	Left / Right Hand?	Description	Price per Pitch
ALAWSIHTF	LH	IH Tank Fill - 9 7/8" x 1 7/8" x 7 3/4"	\$42.75
ALAWSIHVU	RH	IH Vertical Unloading - 12" x 3" x 8 3/4"	\$49.00
ALAWSIHHH	LH	IH Horizontal Tank Fill - 7 5/8" x 1 5/8" x 7 1/2"	\$32.50
ALAWS03C80T	LH	IH 8010 Tank Fill - 12" x 3" x 9 1/2"	\$49.00
ALAWSIHHU	RH	IH Horizontal Unloading - 11 1/2 x 3 x 12	\$49.00
ALAWSJD50TF	RH	JD 50 Ser. Tank Fill - 10" x 2 1/2" x 9 1/2"	\$42.75
ALAWSJD94TF	RH	JD 9400-9410 Tank Fill - 8 1/2" X 2 1/2" X 7 1/2"	\$37.25
ALAWSJD95TF	RH	JD 9500-9510 Tank Fill - 8 1/2" x 2 1/2" x 7 1/2"	\$37.25
ALAWSJD96TF	RH	JD 9600-9610 Tank Fill - 9 1/4" x 2 1/2" x 8 1/4"	\$42.75
ALAWS03JCLO	LH	JD 9400-9600, 9410-9610 Tank Cross 7 1/2" X 2" X 8 3/4"	\$36.55
ALAWS03JCRO	RH	JD 9400-9600, 9410-9610 Tank Cross 7 1/2" X 2" X 8 3/4"	\$36.55
ALAWS03J70T	RH	JD 9770-9879 Tank Fill - 11" x 2 1/2" x 10 3/4"	\$45.75
ALAWSJDVU	LH	JD Vertical Unloading - 13" x 4 1/2" x 9"	\$52.50
ALAWSJDHU278	LH	JD Horizontal Unloading 2 7/8"C - 12" x 2 7/8" x 13"	\$49.00
ALAWSJDHU312	LH	JD Horizontal Unloading 3"C - 12" x 3 1/2" x 13"	\$49.00
ALAWSJD77TF	LH	JD 7720, 8820 Tank Fill - 8" x 1 3/4" x 8 1/4"	\$32.50
ALAWSJD66TF	LH	JD 6620 Tank Fill - 6 3/4" x 1 11/16" x 7 1/2"	\$28.25
ALAWSK12H	LH	Kinze 12" Horizontal - 12" x 3 1/2" x 12"	\$49.00
ALAWSK14	RH	Kinze 14" - 14" x 2 7/8" x 14"	\$56.00
ALAWSK16	RH	Kinze 16" - 16" x 4 1/2" x 16"	\$64.25
ALAWSK20	LH	Kinze 20" - 20" x 8" x 21 1/4"	\$89.75

All wear shoes include hardware for installation.

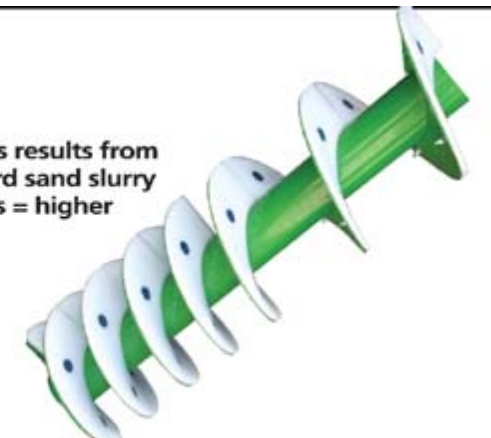
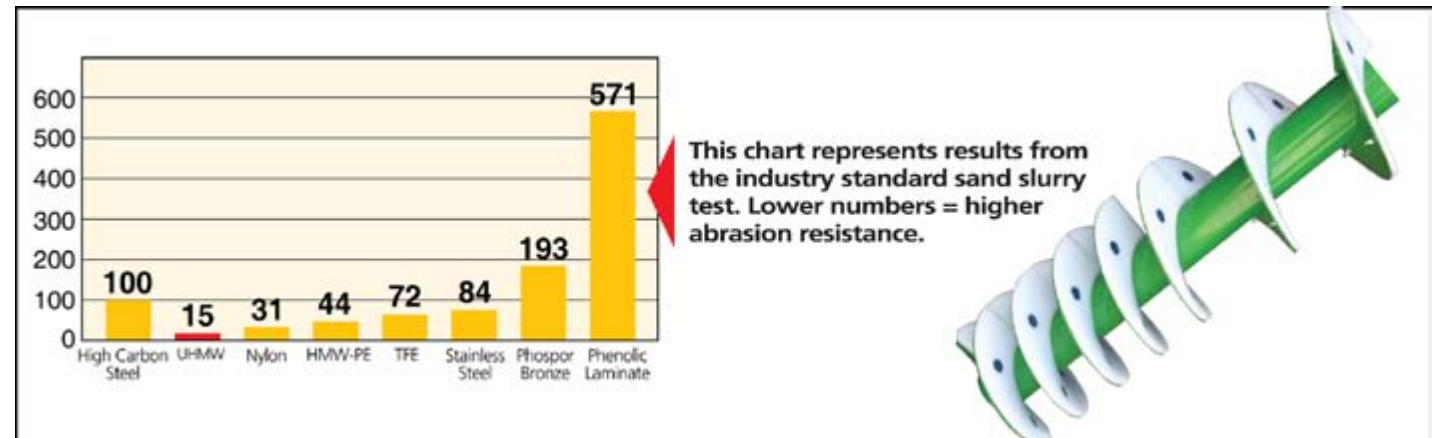

POLY LAST™ CLEAN OUT DOORS FOR CASE IH



Kits Include FREE Latch Handle!

Replaces Poorly Designed OEM Handle. No more struggling to get door closed!

Fits models: 1420, 1440, 1460, 1470, 1480, 1482 (pull type), 1620, 1640, 1644, 1660, 1666, 1670, 1680, 1682, 1688, 2144, 2166, 2188, 2344, 2366, 2377, 2388, 2577 and 2588 combines.

Part #: AEDCL001.....\$17.00

Poly Tech Part # AEDC250C1K replaces Factory Part # 1310250C1 (Door width is 7 1/4")	\$78.00
Fits 1420 and 1620 Combines	
Poly Tech Part # AEDC146C1K replaces Factory Part # 1309146C1 (Door width is 8")	\$78.00
Fits 1440, 1460 and 1470 Combines.	
Poly Tech Part # AEDC037C1K replaces Factory Part # 1309037C1 (Door width is 8")	\$78.00
Fits 1480 and 1482 (PULL TYPE) Combines	
Poly Tech Part # AEDC276C1K replaces Factory Part # 1317276C1 Door width is 7 1/2")	\$113.00
Fits 1640, 1644, 1660, 1666, 1670, 2144, 2166, 2344 and 2366 Combines	
Poly Tech Part # AEDC430C1K replaces Factory Part # 1317430C1 (Door width is 9 1/2")	\$125.00
Fits 1680, 1682, 1688, 2188, 2377, 2388, 2577 and 2588 Combines	
Poly Tech Part # AEDC0124K replaces Factory Part # 87330124 (Door width is 10")	\$162.00
Fits 5088, 6088 and 7088 Combines before serial number Y9002404	
Poly Tech Part # AEDC9722K replaces Factory Part # 84149722 (Door width is 10")	\$162.00
Fits 5088, 5130, 6088, 6130, 7088 and 7130 Combines after serial number Y9002404	
Poly Tech Part # AEDC2183K replaces Factory Part # 87282183 (Door width is 10 3/4")	\$190.00
Fits 7010, 7120, 7230, 8010, 8120, 8230, 9120 and 9230 Combines	

* Kits include door assembled with springs, spring guides and U-bolt with nuts.

CASE IH CLEAN GRAIN ELEVATOR AUGER COVER

Poly Tech Part # ACCK42C1 - \$34.00

Replaces Factory Part # 1317442C1
Fits: Models 1680, 1688, 2188, 2377, 2388, 2577 & 2588

Poly Tech Part # ACCK52C1 - \$83.00

Replaces Factory Part # 1317452C1
Fits: Models 1640, 1644, 1660, 1666, 2144, 2166, 2344 & 2366



POLY LAST™ CLEAN OUT DOORS FOR JOHN DEERE

Tailings Elevator Doors

Poly Tech Part #AEDJ786 replaces Factory Part # AH217786	\$72.00
Fits 9650STS, 9750STS, 9860STS, 9560STS, 9570STS, 9870STS, S550STS, S650STS, S660STS and S670STS Combines	
Poly Tech Part #AEDJ729 replaces Factory Part # AH234729	\$110.00
Fits S680STS & S690STS Combines	



Clean Grain Elevator Doors

Poly Tech Part # AEDJ357 replaces Factory Part # AH129357. (Door width is 8 1/2")	\$96.00
Fits 9400 Maximizer, 9410 Maximizer, 9500 Maximizer, 9500 Sidehill, 9510, SH9510 Maximizer, 9501 Pull Type, CTS North American Edition & CTS II North American Edition (ser.# 675101-679050) Combines	
Poly Tech Part # AEDJ358 replaces Factory Part # AH129358. (Door Width: 10 1/8")	\$113.00
Fits 9600 Maximizer, 9610 Maximizer & CTS II European Edition (ser.# 675101-679050) Combines	
Poly Tech Part # AEDJ426 replaces Factory Part # AH138426 (Door Width: 11")	\$125.00
Fits 9450 Self Propelled, 9550, 9550 Self Propelled, 9650 Self Propelled, 9650 CTS Self Propelled, 9650STS, 9660STS, 9670STS, 9760STS, 9770STS, 9860STS, 9870STS & 9750STS, S550, S660, S670, S680, S690 Combines	



POLY LAST™ CLEAN OUT DOORS FOR AGCO

Poly Tech Part # AEDA529 replaces Gleaner OEM Part # 71500529. (Door width is 12 1/2")	\$165.00
Fits Gleaner R65, R66, R75, R76, S67 and S77 Combines	
Poly Tech Part # AEDA431 replaces Massey OEM Part # 71400431. (Door Width: 13")	\$176.00
Fits 9520, 9690, 9695, 9795 and 9895 Combines	

Protect your tracks or tires from today's tougher hybrid stalks. Poly Tech developed the Stubble Stopper to be the lightest unit on the market. At 22 lbs. per row they are 50% to 60% lighter than other models. The Stubble Stopper features a 10" wide by 1/2" thick Poly Last™ UHMW shoe mounted to a flexible spring and brackets using simple pin locations and polyurethane bumpers for easy height adjustment. The shoe assembly easily flips up for transport.



UNIVERSAL STUBBLE STOPPER KITS

Part #	Description	Price
SSUK001	Universal Kit for a SINGLE row	\$320.00 ea.
SSUK201	Universal Kit for 2 to 6 Rows	\$640.00 / pr.
	Universal Kit for 8 to 10 Rows	\$590.00 / pr.
	Universal Kit for 12+ Rows	\$540.00 / pr.

JOHN DEERE 40/90 SERIES

Part #	Description	Price
SSJK001	John Deere Kit for a SINGLE row	\$320.00 ea.
SSJK201	John Deere Kit for 2 to 6 Rows	\$640.00 / pr.
	John Deere Kit for 8 to 10 Rows	\$590.00 / pr.
	John Deere Kit for 12+ Rows	\$540.00 / pr.

* These stubble stoppers bolt on and do not require a tool bar.

JOHN DEERE 40/90 SERIES Row 3 & 6 Only on 8 Row

Part #	Description	Price
SSJK202	John Deere Kit for Rows 3 & 6 ONLY on 8 Row	\$640.00 / pr.

* These stubble stoppers bolt on and do not require a tool bar.

CASE IH 1000 SERIES

Part #	Description	Price
SSCK003	CASE IH Kit for a SINGLE row	\$320.00 ea.
SSCK203	CASE IH Kit for 2 to 6 Rows	\$640.00 / pr.
	CASE IH Kit for 8 to 10 Rows	\$590.00 / pr.
	CASE IH Kit for 12+ Rows	\$540.00 / pr.

CASE IH 2200, 2400, 3200 & 3400 SERIES

Part #	Description	Price
SSCK002	CASE IH Kit for a SINGLE row	\$320.00 ea.
SSCK202	CASE IH Kit for 2 to 6 Rows	\$640.00 / pr.
	CASE IH Kit for 8 to 10 Rows	\$590.00 / pr.
	CASE IH Kit for 12+ Rows	\$540.00 / pr.

CASE IH 2600, 4200 & 4400 SERIES

Part #	Description	Price
SSCK001	CASE IH Kit for a SINGLE row	\$320.00 ea.
SSCK201	CASE IH Kit for 2 to 6 Rows	\$640.00 / pr.
	CASE IH Kit for 8 to 10 Rows	\$590.00 / pr.
	CASE IH Kit for 12+ Rows	\$540.00 / pr.

CASE IH 2606 series - Rows 2 & 5 Only

Part #	Description	Price
SSCK211	CASE IH Kit for Rows 2 & 5 ONLY	\$640.00 / pr.

The Stubble Stoppers on this page bolt on and do not require a tool bar.

STUBBLE STOPPERS

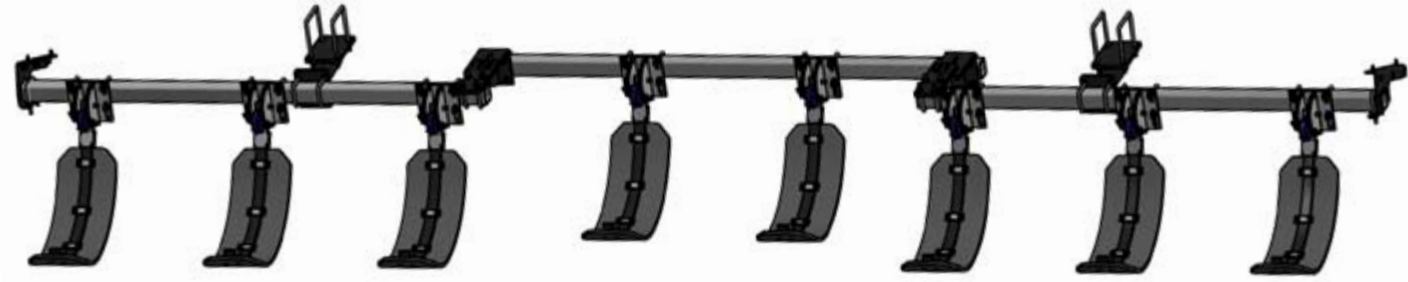

JOHN DEERE 600 SERIES

Model	Row Width	# Rows	Tool Bar Mount #	Tool Bar Price	# OF SSUK201 (Stopper Pairs)	Total Kit Cost
606	30"	2	TBMJK001	\$354.00	1	\$994.00
606	30"	4	TBMJK001	\$354.00	2	\$1,634.00
606	30"	6	TBMJK002	\$571.00	3	\$2,491.00
606	36" / 38"	2	TBMJK003	\$415.00	1	\$1,055.00
606	36" / 38"	4	TBMJK003	\$415.00	2	\$1,695.00
606	36" / 38"	6	TBMJK004	\$715.00	3	\$2,635.00
608	30"	2	TBMJK001	\$354.00	1	\$994.00
608	30"	4	TBMJK001	\$354.00	2	\$1,634.00
608	30"	8	TBMJK005	\$720.00	4	\$3,080.00
608	36" / 38"	2	TBMJK003	\$415.00	1	\$1,055.00
608	36" / 38"	4	TBMJK003	\$415.00	2	\$1,695.00
608	36" / 38"	8	TBMJK006	\$770.00	4	\$3,130.00
612	20" / 22"	4	TBMJK003	\$415.00	2	\$1,695.00
612	20" / 22"	6	TBMJK003	\$415.00	3	\$2,335.00
612	20" / 22"	8	TBMJK007	\$685.00	4	\$3,045.00
612	20" / 22"	12	TBMJK008	\$899.00	6	\$4,139.00
612	30"	4	TBMJK003	\$415.00	2	\$1,695.00
612	30"	6	TBMJK003	\$415.00	3	\$2,335.00
612	30"	12	TBMJK009	\$1,068.00	6	\$4,308.00
616	30"	2	TBMJK003	\$415.00	1	\$1,055.00
616	30"	4	TBMJK003	\$415.00	2	\$1,695.00
616	30"	16	TBMJK010	\$1,206.00	8	\$5,526.00
618	20" / 22"	4	TBMJK003	\$415.00	2	\$1,695.00
618	20" / 22"	6	TBMJK003	\$415.00	3	\$2,335.00
618	20" / 22"	18	TBMJK011	\$1,147.00	9	\$6,007.00

STUBBLE STOPPERS

STUBBLE STOPPER KITS

Part #	Description	Price
SSUK001	Universal Kit for a SINGLE row	\$320.00 ea.
SSUK201	Universal Kit for 2 to 6 Rows	\$640.00 / pr.
	Universal Kit for 8 to 10 Rows	\$590.00 / pr.
	Universal Kit for 12+ Rows	\$540.00 / pr.



GERINGHOFF ROTA DISC & NORTHSTAR KITS UP TO 2011

Model	Row Width	# Rows	Tool Bar Mount #	Tool Bar Price	# OF SSUK201 (Stopper Pairs)	Total Kit Cost
6 Row Up to 2011	30"	2	TBMGK101	\$314.00	1	\$954.00
6 Row Up to 2011	30"	4	TBMGK101	\$314.00	2	\$1,594.00
6 Row Up to 2011	30"	6	TBMGK101	\$314.00	3	\$2,234.00
8 Row Up to 2011	30"	2	TBMGK102	\$364.00	1	\$1,004.00
8 Row Up to 2011	30"	4	TBMGK102	\$364.00	2	\$1,644.00
8 Row Up to 2011	30"	6	TBMGK102	\$364.00	3	\$2,284.00
8 Row Up to 2011	30"	8	TBMGK102	\$364.00	4	\$2,724.00
12 Row Up to 2011	30"	4	TBMGK103	\$653.00	2	\$1,933.00
12 Row Up to 2011	30"	6	TBMGK103	\$653.00	3	\$2,573.00
12 Row Up to 2011	30"	8	TBMGK103	\$653.00	4	\$3,013.00
12 Row Up to 2011	30"	12	TBMGK103	\$653.00	6	\$3,893.00
12 Row Up to 2011	20"	4	TBMGK104	\$519.00	2	\$1,799.00
12 Row Up to 2011	20"	6	TBMGK104	\$519.00	3	\$2,439.00
12 Row Up to 2011	20"	8	TBMGK104	\$519.00	4	\$2,879.00
12 Row Up to 2011	20"	12	TBMGK104	\$519.00	6	\$3,759.00
12 Row Up to 2011	22"	4	TBMGK105	\$577.00	2	\$1,857.00
12 Row Up to 2011	22"	6	TBMGK105	\$577.00	3	\$2,497.00
12 Row Up to 2011	22"	8	TBMGK105	\$577.00	4	\$2,937.00
12 Row Up to 2011	22"	12	TBMGK105	\$577.00	6	\$3,817.00

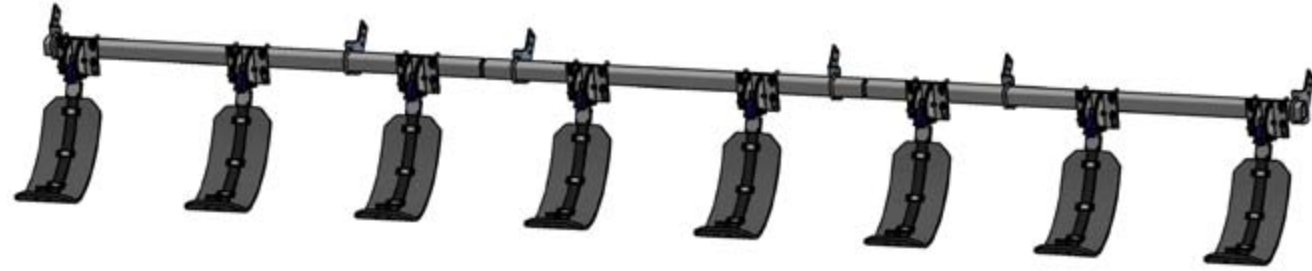

GERINGHOFF ROTA DISC & NORTHSTAR KITS 2012 & LATER

Model	Row Width	# Rows	Tool Bar Mount #	Tool Bar Price	# OF SSUK201 (Stopper Pairs)	Total Kit Cost
6 Row 2012 & Later	30"	2	TBMGK201	\$265.00	1	\$905.00
6 Row 2012 & Later	30"	4	TBMGK201	\$265.00	2	\$1,545.00
6 Row 2012 & Later	30"	6	TBMGK201	\$265.00	3	\$2,185.00
8 Row 2012 & Later	30"	2	TBMGK202	\$321.00	1	\$961.00
8 Row 2012 & Later	30"	4	TBMGK202	\$321.00	2	\$1,601.00
8 Row 2012 & Later	30"	6	TBMGK202	\$321.00	3	\$2,241.00
8 Row 2012 & Later	30"	8	TBMGK202	\$321.00	4	\$2,681.00
12 Row 2012 & Later	30"	4	TBMGK203	\$607.00	2	\$1,887.00
12 Row 2012 & Later	30"	6	TBMGK203	\$607.00	3	\$2,527.00
12 Row 2012 & Later	30"	8	TBMGK203	\$607.00	4	\$2,967.00
12 Row 2012 & Later	30"	12	TBMGK203	\$607.00	6	\$3,847.00
12 Row 2012 & Later	20"	4	TBMGK204	\$451.00	2	\$1,731.00
12 Row 2012 & Later	20"	6	TBMGK204	\$451.00	3	\$2,371.00
12 Row 2012 & Later	20"	8	TBMGK204	\$451.00	4	\$2,811.00
12 Row 2012 & Later	20"	12	TBMGK204	\$451.00	6	\$3,691.00
12 Row 2012 & Later	22"	4	TBMGK205	\$468.00	2	\$1,748.00
12 Row 2012 & Later	22"	6	TBMGK205	\$468.00	3	\$2,388.00
12 Row 2012 & Later	22"	8	TBMGK205	\$468.00	4	\$2,828.00
12 Row 2012 & Later	22"	12	TBMGK205	\$468.00	6	\$3,708.00
8 Row 2012 & Later	36" / 38"	2	TBMGK206	\$475.00	1	\$1,115.00
8 Row 2012 & Later	36" / 38"	4	TBMGK206	\$475.00	2	\$1,755.00
8 Row 2012 & Later	36" / 38"	6	TBMGK206	\$475.00	3	\$2,395.00
8 Row 2012 & Later	36" / 38"	8	TBMGK206	\$475.00	4	\$2,835.00
12 Row 2012 & Later	30" Folding	4	TBMGK207	\$703.00	2	\$1,983.00
12 Row 2012 & Later	30" Folding	6	TBMGK207	\$703.00	3	\$2,623.00
12 Row 2012 & Later	30" Folding	8	TBMGK207	\$703.00	4	\$3,063.00
12 Row 2012 & Later	30" Folding	12	TBMGK207	\$703.00	6	\$3,943.00

LEXION & CAPELLO
MORE COMING SOON!

Model	Row Width	# Rows	Tool Bar Mount #	Tool Bar Price	# OF SSUK201 (Stopper Pairs)	Total Kit Cost
12 Row	30"	4	TBMLK103	\$598.00	2	\$1,878.00
12 Row	30"	6	TBMLK103	\$598.00	3	\$2,518.00
12 Row	30"	8	TBMLK103	\$598.00	4	\$2,958.00
12 Row	30"	12	TBMLK103	\$598.00	6	\$3,838.00
12 Row	22"	4	TBMLK104	\$405.00	2	\$1,685.00
12 Row	22"	6	TBMLK104	\$405.00	3	\$2,325.00
12 Row	22"	8	TBMLK104	\$405.00	4	\$2,765.00
12 Row	22"	12	TBMLK104	\$405.00	6	\$3,645.00

DRAGO
MORE COMING SOON!

Model	Row Width	# Rows	Tool Bar Mount #	Tool Bar Price	# OF SSUK201 (Stopper Pairs)	Total Kit Cost
6 Row	30"	2	TBMDK001	\$432.00	1	\$1,072.00
6 Row	30"	4	TBMDK001	\$432.00	2	\$1,712.00
6 Row	30"	6	TBMDK001	\$432.00	3	\$2,352.00
8 Row	30"	2	TBMDK002	\$575.00	1	\$1,215.00
8 Row	30"	4	TBMDK002	\$575.00	2	\$1,855.00
8 Row	30"	6	TBMDK002	\$575.00	3	\$2,495.00
8 Row	30"	8	TBMDK002	\$575.00	4	\$2,935.00
12 Row	30"	4	TBMDK003	\$775.00	2	\$2,055.00
12 Row	30"	6	TBMDK003	\$775.00	3	\$2,695.00
12 Row	30"	8	TBMDK003	\$775.00	4	\$3,135.00
12 Row	30"	12	TBMDK003	\$775.00	6	\$4,015.00
8 Row Folding	30"	2	TBMDK004	\$865.00	1	\$1,505.00
8 Row Folding	30"	4	TBMDK004	\$865.00	2	\$2,145.00
8 Row Folding	30"	6	TBMDK004	\$865.00	3	\$2,785.00
8 Row Folding	30"	8	TBMDK004	\$865.00	4	\$3,225.00
12 Row Folding	30"	4	TBMDK005	\$935.00	2	\$2,215.00
12 Row Folding	30"	6	TBMDK005	\$935.00	3	\$2,855.00
12 Row Folding	30"	8	TBMDK005	\$935.00	4	\$3,295.00
12 Row Folding	30"	12	TBMDK005	\$935.00	6	\$4,175.00

- **Protect your tracks or tires from today's tougher hybrid stalks!**
- **Only 22 lbs. per row making them 50-60% lighter than other models!**
- **Easy height adjustment!**
- **Flip up for storage or transport!**

STALK STOMPER REPLACEMENT SHOES

Replaces Standard OEM Poly Shoes

LANKOTA POLY REPLACEMENT SHOE

Part #	Description	Price
SSLNK001	Replaces Lankota #LANSS600POLYK	\$47.00 / pr.

MAY WES POLY REPLACEMENT SHOE

Part #	Description	Price
SSMWK001	Replaces 9" May Wes #40012	\$47.00 / pr.

SHOUP POLY REPLACEMENT SHOE

Part #	Description	Price
SSSHK001	Replaces 9" Shoup #69900	\$47.00 / pr.



CORN HEAD AUGER TROUGH LINERS

When ordering please specify corn head model number, model number of combine it is attached to, feeder opening width, & any modifications made to the head. Liner will accommodate gaps up to 6" on heads with modified widths (i.e. custom narrow row heads). Liners can be installed over worn metal & holes in trough if the holes do not exceed 3 in. in width by 18 in. in length. Installation does not require removal of the auger. Just raise the auger to its maximum height, install liner, & adjust the auger to the desired height.

CASE IH 800 SERIES

Part #	Description	Price
ACHC84333	Liner for 843 - 33" opening	\$215.00
ACHC84342	Liner for 843 - 42" opening	\$215.00
ACHC84433	Liner for 844 - 33" opening	\$260.00
ACHC84442	Liner for 844 - 42" opening	\$260.00
ACHC85433	Liner for 854 - 33" opening	\$338.00
ACHC86333	Liner for 863 - 33" opening (same hdw. as 6333)	\$283.00
ACHC86342	Liner for 863 - 42" opening	\$283.00
ACHC86433	Liner for 864 - 33" opening	\$463.00
ACHC86442	Liner for 864 - 42" opening	\$463.00
ACHC88333	Liner for 883 - 33" opening	\$478.00
ACHC88342	Liner for 883 - 42" opening	\$478.00
ACHC88433	Liner for 884 - 33" opening	\$538.00
ACHC88442	Liner for 884 - 42" opening	\$538.00

CASE IH 900/1000 SERIES

Part #	Description	Price
ACHC4333	Liner for 943/1043 - 33" opening	\$215.00
ACHC4342	Liner for 943/1043 - 42" opening	\$215.00
ACHC4433	Liner for 944/1044 - 33" opening	\$260.00
ACHC4442	Liner for 944/1044 - 42" opening	\$260.00
ACHC5433	Liner for 954/1054 - 33" opening	\$314.00
ACHC5442	Liner for 954/1054 - 42" opening	\$314.00
ACHC6333	Liner for 963/1063 - 33" opening	\$291.00
ACHC6342	Liner for 963/1063 - 42" opening	\$291.00
ACHC6433	Liner for 964/1064 - 33" opening	\$452.00
ACHC6442	Liner for 964/1064 - 42" opening	\$452.00
ACHC8333	Liner for 983/1083 - 33" opening	\$478.00
ACHC8342	Liner for 983/1083 - 42" opening	\$478.00
ACHC8433	Liner for 984/1084 - 33" opening	\$538.00
ACHC8433-40	Liner for 984/1084 - 33" opening with 40" row	\$564.00
ACHC8442	Liner for 984/1084 - 42" opening	\$538.00
ACHC8442-40	Liner for 984/1084 - 42" opening with 40" row	\$564.00
ACHC12342	Liner for 1000 Series 12 row - 42" opening	\$627.00

CASE IH 2200, 2400, 3200 & 3400

Part #	Description	Price
ACHCK010630	Liner for 6 row 30" 2200, 2400, 3200 & 3400	\$544.00
ACHCK010830	Liner for 8 row 30" 2200, 2400, 3200 & 3400	\$661.00
ACHCK010836	Liner for 8 row 36" 2200, 2400, 3200 & 3400	\$776.00
ACHCK011220	Liner for 12 row 20" 2200, 2400, 3200 & 3400	\$661.00
ACHCK011222	Liner for 12 row 22" 2200, 2400, 3200 & 3400	\$718.00
ACHCK011230	Liner for 12 row 30" 2200, 2400, 3200 & 3400	\$939.00
ACHCK011630	Liner for 16 row 30" 2200, 2400, 3200 & 3400	\$1,232.00

Installs quickly and easily!

Improves crop flow from the first acre to the last, year after year...

CORN HEAD AUGER TROUGH LINERS

NOTE: These liners cannot be installed on folding models.

CASE IH 2600, 4200 & 4400 SERIES

Part #	Description	Price
ACHCK020630	Liner for 2600, 4200, 4400 - 6 Row 30" Spacing	\$530.00
ACHCK020830	Liner for 2600, 4200, 4400 - 8 Row 30" Spacing	\$777.00
ACHCK021230	Liner for 2600, 4200, 4400 - 12 Row 30" Spacing	\$938.00



POLY LAST™ CORN HEAD AUGER TROUGH LINER

Serial Number required when ordering - Serial Number 690,701-Up (around 2002) will have flighting all the way to center of auger and requires deeper panels.



GREAT VALUE
a fraction of the cost of replacing steel

Other sizes available on request.

JOHN DEERE CORN HEADS 2002 & UP

Part #	Description	Price
ACHJK02643G	JD 643/693/693SH Green Kit 2002 & Newer	\$385.00
ACHJK02643	JD 643/693/693SH Yellow Kit 2002 & Newer	\$422.00
ACHJK02644G	JD 644/694 Green Kit 2002 & Newer	\$468.00
ACHJK02644	JD 644/694 Yellow Kit 2002 & Newer	\$515.00
ACHJK02843G	JD 843/893 Green Kit 2002 & Newer	\$530.00
ACHJK02843	JD 843/893 Yellow Kit 2002 & Newer	\$583.00
ACHJK02844G	JD 844/894 Green Kit 2002 & Newer	\$583.00
ACHJK02844	JD 844/894 Yellow Kit 2002 & Newer	\$641.00
ACHJK02854G	JD 854 Green Kit 2002 & Newer	\$510.00
ACHJK02854	JD 854 Yellow Kit 2002 & Newer	\$554.00
ACHJK021092G	JD 1092 Green Kit 2002 & Newer	\$601.00
ACHJK021092	JD 1092 Yellow Kit 2002 & Newer	\$706.00
ACHJK021290G	JD 1290 Green Kit 2002 & Newer	\$513.00
ACHJK021290	JD 1290Yellow Kit 2002 & Newer	\$577.00
ACHJK021293G	JD 1293 Green Kit 2002 & Newer	\$704.00
ACHJK021293	JD 1293Yellow Kit 2002 & Newer	\$781.00

JOHN DEERE

Part #	Description	Price
ACHJ443G	JD 443/493 Green Kit	\$321.00
ACHJ443	JD 443/493 Yellow Kit	\$353.00
ACHJ444G	JD 444/494 Green Kit	\$339.00
ACHJ444	JD 444/494 Yellow Kit	\$372.00
ACHJ643G	JD 643/693/693SH Green Kit	\$365.00
ACHJ643	JD 643/693/693SH Yellow Kit	\$401.00
ACHJ644G	JD 644/694 Green Kit	\$446.00
ACHJ644	JD 644/694 Yellow Kit	\$492.00
ACHJ843G	JD 843/893 Green Kit	\$505.00
ACHJ843	JD 843/893 Yellow Kit	\$556.00
ACHJ844G	JD 844/894 Green Kit	\$556.00
ACHJ844	JD 844/894 Yellow Kit	\$610.00
ACHJ854G	JD 854 Green Kit	\$485.00
ACHJ854	JD 854 Yellow Kit	\$545.00
ACHJ1092G	JD 1092 Green Kit	\$580.00
ACHJ1092	JD 1092 Yellow Kit	\$696.00
ACHJ1290G	JD 1290 Green Kit	\$494.00
ACHJ1290	JD 1290 Yellow Kit	\$556.00
ACHJ1293G	JD 1293 Green Kit	\$670.00
ACHJ1293	JD 1293Yellow Kit	\$745.00

Installs quickly and easily!
.....
Improves crop flow from the first acre to the last, year after year...



JOHN DEERE CORN HEADS 600C SERIES

2007 - 2011 MODELS (serial #745100 and BELOW)

Part #	Description	Price
ACHJK606C30	JD 600C Corn Head Auger Trough Liner - 6 Row 30" Spacing	\$ 567.00
ACHJK606C36	JD 600C Corn Head Auger Trough Liner - 6 Row 36" Spacing	\$ 668.00
ACHJK608C30	JD 600C Corn Head Auger Trough Liner - 8 Row 30" Spacing	\$ 737.00
ACHJK608C36	JD 600C Corn Head Auger Trough Liner - 8 Row 36" Spacing	\$ 865.00
ACHJK612C30	JD 600C Corn Head Auger Trough Liner - 12 Row 30" Spacing	\$1,031.00
ACHJK612C22	JD 600C Corn Head Auger Trough Liner - 12 Row 22" Spacing	\$ 817.00

2012+ MODELS (serial #745101 and ABOVE)

Part #	Description	Price
ACHJK02606C30	JD 600C Corn Head Auger Trough Liner - 6 Row 30" Spacing	\$ 567.00
ACHJK02606C36	JD 600C Corn Head Auger Trough Liner - 6 Row 36" Spacing	\$ 668.00
ACHJK02608C30	JD 600C Corn Head Auger Trough Liner - 8 Row 30" Spacing	\$ 737.00
ACHJK02608C36	JD 600C Corn Head Auger Trough Liner - 8 Row 36" Spacing	\$ 865.00
ACHJK02612C30	JD 600C Corn Head Auger Trough Liner - 12 Row 30" Spacing	\$1,031.00
ACHJK02612C22	JD 600C Corn Head Auger Trough Liner - 12 Row 22" Spacing	\$ 817.00
ACHJK02618C22	JD 600C Corn Head Auger Trough Liner - 18 Row 22" Spacing	\$1,058.00

NEW HOLLAND 96C, 96D, 98C & 98D

Part #	Description	Price
ACHNK030630	Liner for 6 row 30" 96C, 96D, 98C & 98D	\$387.00
ACHNK030830	Liner for 8 row 30" 96C, 96D, 98C & 98D	\$501.00
ACHNK030836	Liner for 8 row 36" 96C, 96D, 98C & 98D	\$562.00
ACHNK031220	Liner for 12 row 20" 96C, 96D, 98C & 98D	\$502.00
ACHNK031222	Liner for 12 row 22" 96C, 96D, 98C & 98D	\$521.00
ACHNK031230	Liner for 12 row 30" 96C, 96D, 98C & 98D	\$901.00



POLY LAST™ CORN HEAD AUGER TROUGH LINER



AGCO "HUGGER"

Part #	Description	Price
ACHAK0630	Auger Trough Liner fits 6 Row 30" Spacing	\$542.00
ACHAK0830	Auger Trough Liner fits 8 Row 30" Spacing	\$594.00
ACHAK1220	Auger Trough Liner fits 12 Row 20" Spacing	\$599.00
ACHAK1222	Auger Trough Liner fits 12 Row 22" Spacing	\$670.00
ACHAK1230	Auger Trough Liner fits 12 Row 30" Spacing	\$772.00

GERINGHOFF 2007 THRU 2011 MODELS

Part #	Description	Price
ACHGK010630	Liner for 2007-2011 fits 6 Row 30" Spacing	\$582.00
ACHGK010830	Liner for 2007-2011 fits 8 Row 30" Spacing	\$771.00
ACHGK011230	Liner for 2007-2011 fits 12 Row 30" Spacing	\$1,133.00
ACHGK011630	Liner for 2007-2011 fits 16 Row 30" Spacing	\$1,442.00
ACHGK011222	Liner for 2007-2011 fits 12 Row 22" Spacing	\$863.00
ACHGK011220	Liner for 2007-2011 fits 12 Row 20" Spacing	\$790.00

Oversize Shipping Charge - Regular Shipping + \$50.00.



Note: These liners cannot be installed on folding models.

GERINGHOFF 2012 TO PRESENT

Part #	Description	Price
ACHGK020630	Liner for 2012-Present fits 6 Row 30" Spacing	\$582.00
ACHGK020830	Liner for 2012-Present fits 8 Row 30" Spacing	\$771.00
ACHGK021230	Liner for 2012-Present fits 12 Row 30" Spacing	\$1,133.00
ACHGK021222	Liner for 2012-Present fits 12 Row 22" Spacing	\$863.00

Oversize Shipping Charge - Regular Shipping + \$50.00.

GERINGHOFF CORNHEAD BONNET

Part #	Description	Price
CHBG001	Fits 20" Row	\$24.00
CHBG002	Fits 30" Row	\$32.00
CHBG003	Fits 22" Row	\$26.00

*** Please provide row spacing when ordering.**

● Poly Last™ is super slick and more flexible than stock rubber bonnets, which results in better feeding even in downed corn.



JOHN DEERE SNOOT GUARDS

For John Deere 90 Series Corn Head

Part #	Description	Price
CHSGJK001	Fits all snouts up to serial #695000	\$31.00 pr.
CHSGJK002	Fits INSIDE snouts on serial #695001 and up with 30" row spacing	\$31.00 pr.
CHSGJK002E	Fits OUTSIDE snouts on serial #695001 and up	\$31.00 pr.



JOHN DEERE HOOD PATCH KIT

Part #	Description	Price
HPJK9000	Hood Patch Kit for John Deere 90 Series and John Deere 600 Series, inside rows only	\$42.00 pr.

*Requires 1 pair per row.



CASE, NEW HOLLAND & HARVESTEC HOOD PATCH KITS

Part #	Description	Price
HPCK2288	Hood Patch Kit for Case IH Corn Heads DOES NOT FIT CASE IH 1000 SERIES	\$53.00 pr.
HPNHK2288	Hood Patch Kit for New Holland Corn Heads	\$53.00 pr.
HPHK001	Hood Patch Kit for Harvestec 4000 & 5000 Series	\$62.00 pr.



HARVESTEC 4000 & 5000 SERIES SNOOT GUARDS

Part #	Description	Price
CHSGHK001	Snout Guards for Harvestec 4000 & 5000 Series	\$44.00 pr.



POLY LAST™ MOLDBOARD COVERS

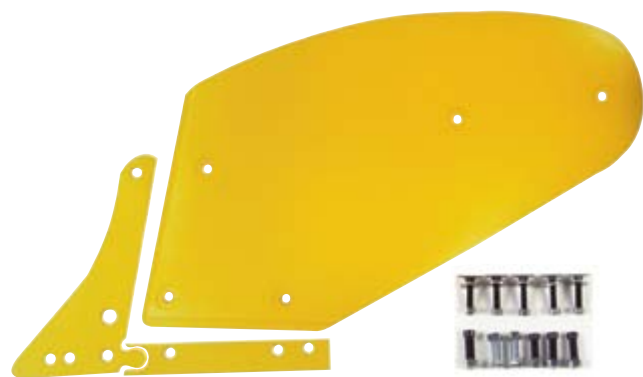

When ordering please specify the moldboard part number located on the back of your steel moldboard.

We will use this number to match the poly cover to your steel. All conventional moldboards come in kit form. Each kit contains: One moldboard cover, spacer for the point and shin, extra length bolts (for moldboards, point and shin) and installation instructions.

Part #	Description	Price
John Deere	14", 16"	\$ 85.00
John Deere	18"	\$ 102.00
Allis Chalmers	14", 16", 18"	\$ 85.00
Massey	14", 16", 18"	\$ 85.00
Ford	14", 16"	\$ 85.00
Ford	18"	\$ 94.00
White Oliver	14", 16"	\$ 85.00
White Oliver	18", 20"	\$ 91.00
International	16", 18"	\$ 85.00
Kvermland	16"	\$108.00
Kvermland	18"	\$115.00
Overum	14"-18"	\$129.00
Kongskilde	14"-18"	\$127.00

All Poly Last™ moldboard kits include hardware. Extra bolt kits are available for cover, point and shin if needed. Call for pricing on bolt kits. Please specify moldboard part number and location of bolts needed when ordering.

POLY LAST™ BIDIRECTIONAL MOLDBOARD

Part #	Description	Price
AMJ3945	John Deere 3945/55 Kit (3/8" Reversible)	\$94.00
AMJ964-965	John Deere 964 & 965 Kit	\$64.00
AMJ995	John Deere 995 Kit	\$64.00
AMBH25	Harrell 1/4" x 18" x 20" Kit	\$64.00
AMBT25	Tatu Marchesan Kit	\$64.00
AMBL25	Long 1/4" x 21 1/4" x 24" Kit	\$64.00
AMBL255	Long 1/4" x 21 3/8" x 21 1/2" Kit	\$69.00
AMBB38	Baker (3/8" Reversible) Kit	\$94.00



Due to design, the bidirectional or switch plow produces far more drag than a conventional moldboard plow. Our Poly Last™ moldboards and covers have a super low coefficient of friction that dramatically reduces drag. Less resistance reduces soil flow and improves turn over. It also reduces stress on your equipment, improving fuel economy and reducing maintenance costs. These results are most noticeable in heavy or sticky ground but almost everyone can benefit from the addition of Poly Last™ moldboards and covers.

HINIKER 6000 STRIP TILL RIDGING WING

Covers Hiniker Part # 810-002-124.

This cover attaches using the two existing 3/8" carriage bolts. The parts have counter bored holes making them left & right handed.



Part #	Description	Price Ea.
APRWH124L	Left Hand Ridging Wing	\$18.00
APRWH124R	Right Hand Ridging Wing	\$18.00

POLY LAST™ DEPTH GAUGE SHOES*

Poly Last™ Depth Gauge Shoes allow you to operate in wet/sticky conditions with no soil buildup. No buildup means more accurate planting depth and higher yield potential.

Part #	Description	Price
ADGJ71	John Deere 71	\$32.00
ADGJ493	John Deere 493	\$32.00
ADGJ51S	John Deere 51-S (15" wide)	\$37.00
ADGJ51M	John Deere 51-M (20" wide)	\$41.00
ADGJ51W	John Deere 51-W (28" wide)	\$63.00
ADGM468	Massey Ferguson 468	\$38.00
ADGM	Massey Ferguson	\$38.00
ADGF3098	Ford 309 - 8"	\$29.00
ADGF30912	Ford 309 - 12"	\$29.00
ADGF354	Ford 354	\$37.00
ADGAC	AC Depth Shoe	\$31.00

Part #	Description	Price
ADGI295	International 295	\$32.00
ADGI296	International 296	\$49.00
ADGI386	International 386	\$49.00
ADGC1800	Cole 1800 Single Row	\$32.00
ADGC20	Cole Single Row 15" x 20"	\$38.00
ADGC23	Cole Twin Row	\$47.00
ADGJEB7	JD Emmitt Bragg 7" x 10 1/4"	\$14.00
ADGJEB10	JD Emmitt Bragg 10" x 10 1/4"	\$16.00
ADGJEB15	JD Emmitt Bragg 15" x 10 1/4"	\$21.00
ADGJDB71	JD Emmitt Bragg Blank 15" x 24"	\$31.00

***NON-STOCKING ITEM - Every effort will be made to ship same or next day but we cannot guarantee shipment date.**

POLY LAST™ STRIP-TILL ACCESSORIES

SHIN & COVER for Redball Strip-till Knife

- Shin and adapter replace the original wear bar.
- Cover eliminates build up on shank sides.
- Protects fertilizer tubes from premature wear.



Part #	Description	Price
ARSCR406	Poly Knife Cover fits 3/4" Redball Knife	\$54.00
ARSSR406	Shin fits 3/4" Redball Knife with cover (requires adapter)	\$25.00
ARSAS200	Metal Adapter for Redball knife	\$16.00

PIVOT SUPPORT FOR ROW CLEANER ARM

Part #	Description	Price
RCRWK001	Redball row cleaner Pivot Support (Washer) sold per pair/row	\$12.00

- Made from UHMW polyethylene.
- Gives pivot arm more support.
- Extends the life of the bronze pivot brushing.
- Tightens up lateral movement of the arm.
- Reduces wear in the pivot area.



HIPPER BEARING HOUSING COVERS

Part #	Description	Price
AHBAM112	AMCO 1 1/8"	\$24.50
AHBAM150	AMCO 1 1/2"	\$24.50
AHBFCK112	Forest City/KMC	\$24.50
AHBJDW112	John Deere/Wil-Rich	\$24.50
AHBWA112	W & A 1 1/8"	\$24.50
AHBWA150	W & A 1 1/2"	\$24.50
AHBBH112	Bush Hog 1 1/8"	\$24.50

- Pre Formed to fit housing contour.
- Premium 1/4" Poly Last™ material.
- Eliminates wear on bearing housing.
- Eliminates buildup in sticky conditions.



POLY LAST™ SHANK GUARDS

Why fight square, sheared off shank guards made from scrap? The radius on the edge of our Poly Last™ shank guard was designed to fit the contour of your shovel. It goes on easier and stays on better. Re-tighten less often without the worry of a lost shovel.

POLY TECH'S EXCLUSIVE RADIUS DESIGN...

- Improves soil flow around shank.
- Reduces drag and stress on equipment.
- Protects expensive steel shanks.
- Does not change shovel angle.
- Sheds roots & soil to eliminate large buildups.

Part #	Description	Price
ASG09	1 3/4" x 9" Shank Guard fits Cultivators w/mounting hole centers: 1 5/8" to 2"	\$1.90
ASG10	2" x 10" Shank Guard fits Chisel Plow w/mounting hole centers: 1 3/4" to 2 1/2"	\$1.90
ASG12	Custom Shank Guard 1 3/4" x Up to 12" fits mounting hole centers: 1 5/8" to 2"	\$2.70
ASG13	Custom Shank Guard 2" x Up to 12" fits mounting hole centers: 1 3/4" to 2 1/2"	\$2.70



POLY LAST™ SQUARE EDGE SHANK GUARDS

Okay, so you don't care if your shank guards are square? We can make them that way too. These are the same shank guards as above with one exception, no radius edge. That saves us an operation in production and saves you money.

Part #	Description	Price
ASGE09	1 3/4" x 9" Shank Guard fits Cultivators w/mounting hole centers: 1 5/8" to 2"	\$1.30
ASGE10	2" x 10" Shank Guard fits Chisel Plow w/mounting hole centers: 1 3/4" to 2 1/2"	\$1.30



POLY LAST™ RIPPER SHINS & COVERS

Poly Last™ covers will reduce drag, eliminate soil buildup on shank and shin and reduce or eliminate soil “blow out.” This allows for a better seed bed and a more profitable crop.

KMC Ripper Shanks are available in THREE widths. To be sure you have the proper shin and/or cover, verify the steel shank number and choose the part numbers as follows:

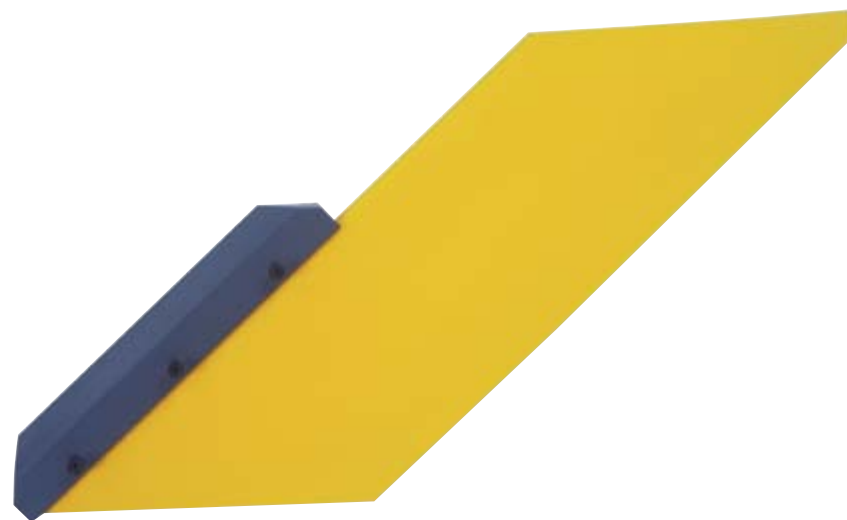

KMC 67-080-213 Generation III

Part #	Description	Price
ARCK213	Cover fits 1" Wide Shank	\$72.00
ARSS150C	Shin fits 1" Shank with cover	\$18.00
ARSS150WO	Shin fits 1" Shank without cover	\$18.00

KMC 67-080-001 Generation III

Part #	Description	Price
ARCK001	Cover fits 1" Wide Shank	\$72.00
ARSS150C	Shin fits 1" Shank with cover	\$18.00
ARSS150WO	Shin fits 1" Shank without cover	\$18.00

KMC 16-080-291 Generation II

Part #	Description	Price
ARCK291	Cover fits 3/4" Wide Shank	\$72.00
ARSS150C	Shin fits 3/4" Shank with cover	\$18.00
ARSS150WO	Shin fits 3/4" Shank without cover	\$18.00

KMC 16-080-292 GENERATION II

Part #	Description	Price
ARCK292	Cover fits 1 1/4" Wide Shank	\$72.00
ARSS175C	Shin fits 1 1/4" Shank with cover	\$18.00
ARSS150WO	Shin fits 1 1/4" Shank without cover	\$18.00

KMC 16-080-077

Part #	Description	Price
ARCK077	Cover fits 1" Wide Shank	\$56.00
ARSS150C	Shin fits 1" Shank with cover	\$18.00
ARSS150WO	Shin fits 1" Shank without cover	\$18.00
ARSSK24	24" Shin fits 1" Wide KMC Shank	\$37.00

KMC 16-080-077B

Part #	Description	Price
ARCK077B	Cover fits 1" Wide Shank with Brace	\$72.00
ARSS150C	Shin fits 1" Shank with cover	\$18.00
ARSS150WO	Shin fits 1" Shank without cover	\$18.00

KMC 16-080-081

Part #	Description	Price
ARCK081	Cover fits 1 1/4" Wide Shank	\$56.00
ARSS175C	Shin fits 1 1/4" Shank with cover	\$18.00
ARSS150WO	Shin fits 1 1/4" Shank without cover	\$18.00

KMC 16-080-190

Part #	Description	Price
ARCK190	Cover fits 1" Wide Shank	\$56.00
ARSS150C	Shin fits 1" Shank with cover	\$18.00
ARSS150WO	Shin fits 1" Shank without cover	\$18.00

POLY LAST™ RIPPER SHINS & COVERS

KMC 16-080-228/246

Part #	Description	Price
ARCK228	Cover fits 1 1/4" Wide Shank	\$56.00
ARSS175C	Shin fits 1 1/4" Shank with cover	\$18.00
ARSS150WO	Shin fits 1 1/4" Shank without cover	\$18.00

KMC 16-080-318

Part #	Description	Price
ARCK228	Poly Cover fits 1 1/4" KMC Shanks	\$56.00
ARSS175C	Poly Shin fits 1 1/4" KMC Shanks w/cover	\$18.00
ARSS150WO	Poly Shin fits 1 1/4" KMC Shanks w/o cover	\$18.00

KMC 50-080-032

Part #	Description	Price
ARCK032	Cover fits 3/4" Wide Shank	\$72.00
ARSS150C	Shin fits 3/4" Shank with cover	\$18.00
ARSS150WO	Shin fits 3/4" Shank without cover	\$18.00

KMC 39-080-002 'V' Shank

Part #	Description	Price
ARSSK080WO	Shin fits KMC "V"	\$18.00

BROWN & HARDING - STRAIGHT

Part #	Description	Price
ARSCBH1	Cover fits Brown & Harding 1" Straight	\$56.00
ARSS150C	Shin fits 1" Shank with cover	\$18.00
ARSS150WO	Shin fits 1" Shank without cover	\$18.00

ORTHMAN

Part #	Description	Price
ARCK575	Cover fits 1 1/4" Orthman Shank	\$56.00
ARSS175C	Shin fits 1 1/4" Shank with cover	\$18.00
ARSS150WO	Shin fits 1 1/4" Shank without cover	\$18.00

UNVERFERTH (Red unless Yellow is specified.)

Part #	Description	Price
ARSCU569	Cover fits 3/4" Shank #63569	\$72.00
ARSCU569B	Bottom Only (same as ARSCU981B)	\$57.00
ARSCU569T	Top Only	\$18.00
ARSCU981	Cover fits 3/4" Shank #63981	\$72.00
ARSCU981B	Bottom Only	\$57.00
ARSCU981T	Top Only	\$18.00
ARSS150C	Shin fits 3/4" Shank #63569 w/cover & #63981	\$18.00
ARSS150WO	Shin fits 3/4" Shank #63569B & 63981B without cover	\$18.00

UNIVERSAL SHIN ADAPTER

Part #	Description	Price
ARSA100	10" Metal Adaptor Strip	\$15.00



POLY LAST™ RIPPER SHINS & COVERS

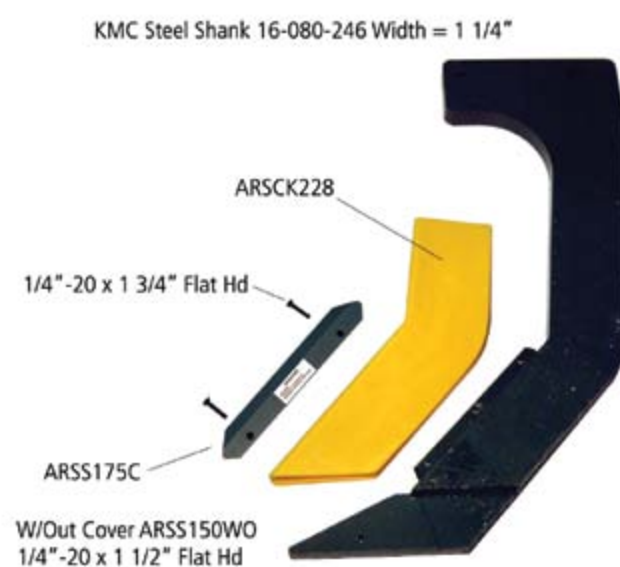
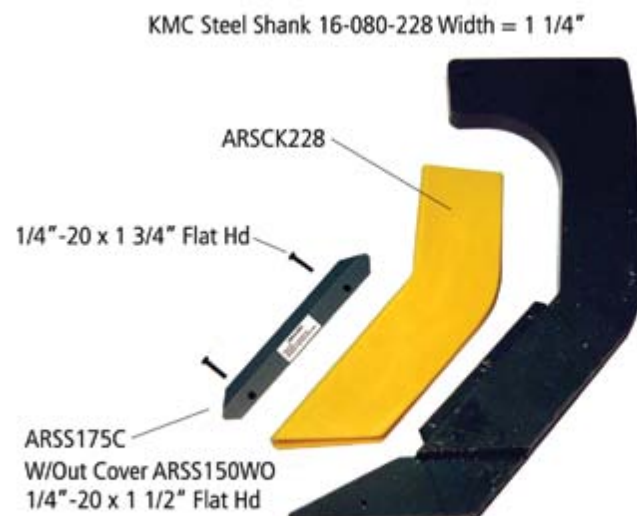
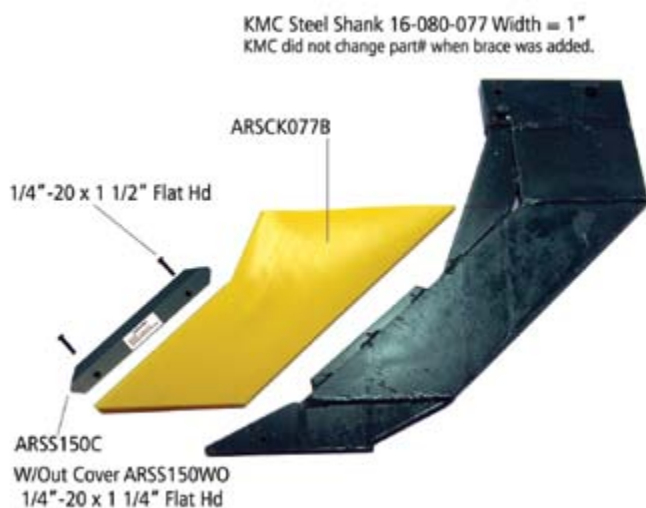
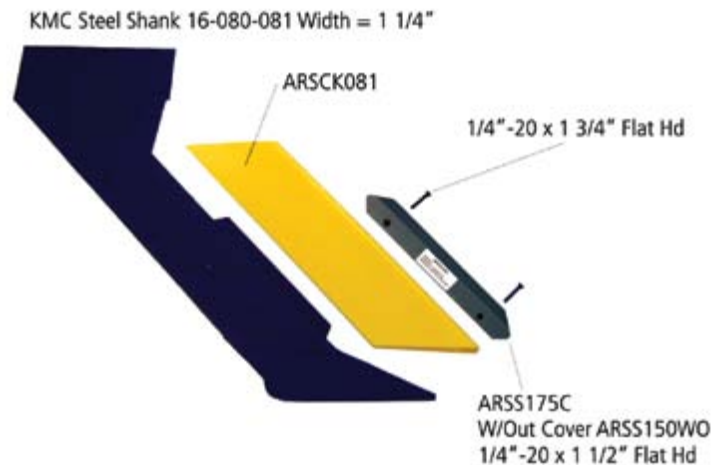
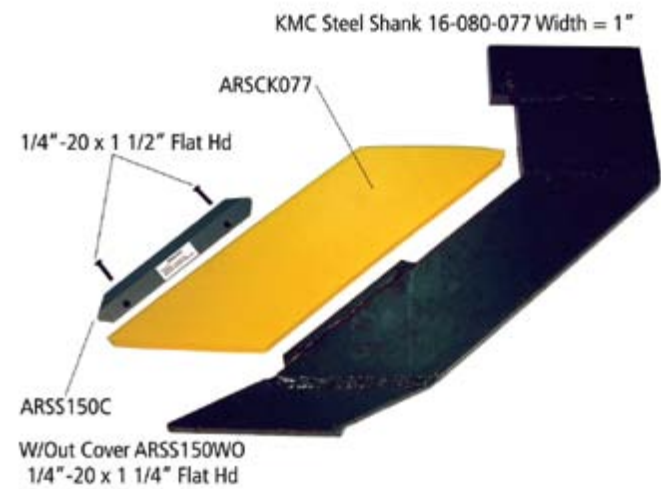

POLY LAST™ RIPPER SHINS & COVERS

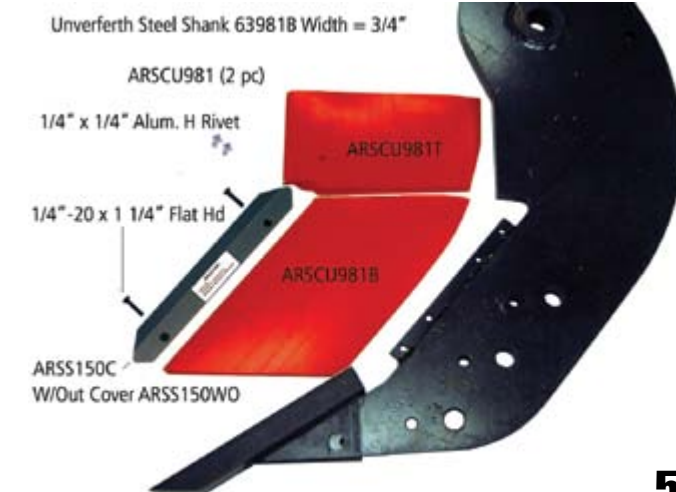
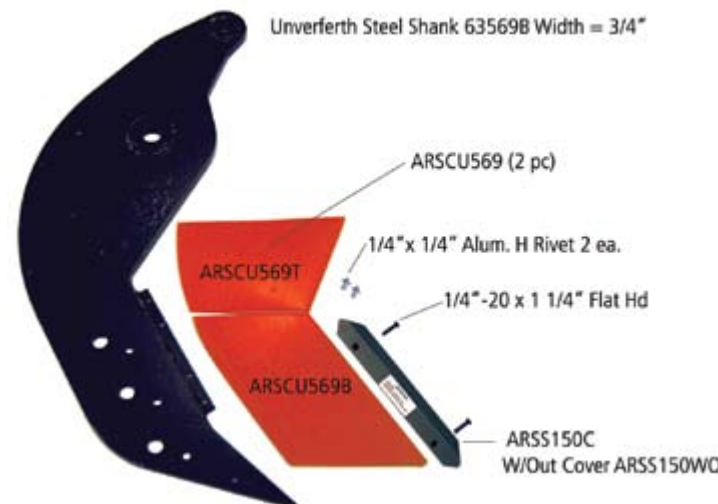

DRILL DRAIN STOP Cleaning Out Your Drill!

JOHN DEERE 750, 1560 & 1590 SERIES BOX DRILL

Part #	Description	Price
DDJD75001	Fits 15' (7 1/2" centers) John Deere 750 Box Drill main seed compartment - Complete 4 pc. Kit	\$280.00
DDJD156001	Fits 15' (7 1/2" centers) John Deere 1560/1590 Box Drill main seed compartment - Complete 4 pc. Kit	\$280.00

* NOT compatible with Grain Agitator, SI Belt Meter or Combination Tank.

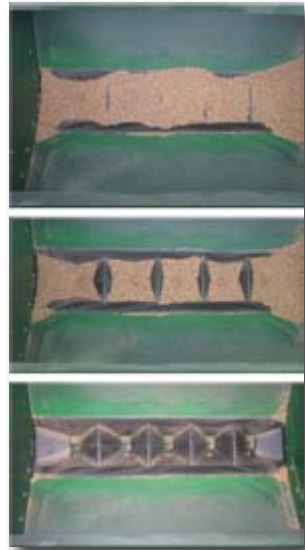

***Tough, High Impact Polymer *"Drop In" design - No Drilling *Minimizes Lateral Seed Shift**

TUNGSTEN CARBIDE PLANTER SCRAPERS

- Simple design.
- Aggressive Cleaning Action.
- Work in wet and dry conditions.
- Easy Installation - No holes to drill.
- Enhances seed depth placement accuracy.
- Tungsten Carbide edge for amazing abrasion, resistance and long lasting performance.

Part #	Description	Price
AD21050	Air Design Scraper for JD 7000-7100 Series & Kinze Kit includes Scrapers, Arms & Spring	\$31.95
AD21051	Air Design Scrapers for JD 7200,7300, 1700-30 1750-80, Kinze* Scrapers Only	\$24.95
AD21053	Air Design Scrapers for White 6000 Series Scrapers Only	\$24.95
AD21056	Air Design Scrapers for Case-IH 800-900 Series Scrapers Only	\$28.95
AD21063L	Air Design LH Scraper for JD 1590, 1890 & 1895 No Till Drill - Seed Tube Side	\$38.95
AD21063R	Air Design RH Scraper for JD 1590, 1890 & 1895 No Till Drill - Seed Tube Side	\$38.95
AD21088	Air Design Scrapers for JD 7200 & Newer - One Piece Design	\$30.95
AD21089	Air Design Scraper Kit for JD MaxEmerge5 & Exact Emerge Opener Units	\$42.95

* If using Kinze Gold seed firmer attachment, special arms are required.

MADE IN USA Other Tungsten Scrapers available upon request. Call for more details.

GET THE EDGE!
Plant when others can't.



PLANTER SCRAPERS ON THIS PAGE COVERED BY ORIGINAL MANUFACTURER'S WARRANTY

AMADAS PEANUT COMBINE HEADER BAND

PEANUT

SPECIAL PRICE!
~~\$55.30 EA.~~

PART #: PCAHB304.....~~\$79.00 EA.~~

Fits Pull-Type models: 9797, 9897, 9997, 9998, 2100, 2108 & 2110

Fits Self-Propel models: 9965, 9865, 9965, 9900 & 9960

Header Length	Required #	Price	SPECIAL!
12 Foot	31 Parts	\$2,449.00	\$1,714.30
16 Foot	43 Parts	\$3,397.00	\$2,377.90
18 Foot	49 Parts	\$3,871.00	\$2,709.70
19 Foot	53 Parts	\$4,187.00	\$2,930.90

- **75% LIGHTER** than the metal bands they replace!
- Extends the life of fingers!
- Poly flexes to withstand rough terrain!

**Replaces Amadas
Part #124304
(Uses Existing Hardware)**



1/4" POLY LINERS FOR AMADAS PEANUT COMBINES



RESTORE worn through ducts to better than new condition.

REDUCE soil build-up and costly down time.

Model #	Serial #	Kit #	Price
9097	ALL	PCAK001	\$ 827.00
9297	ALL	PCAK002	\$ 827.00
9597	ALL	PCAK003	\$ 827.00
9797 - 9797T	ALL	PCAK003	\$ 827.00
9897	A36000 - A36878	PCAK003	\$ 827.00
9897T	A36672 - A36790	PCAK004	\$ 442.00
9997A, B and T	ALL	PCAK004	\$ 442.00
9997E - 9997F	ALL	PCAK003	\$ 827.00
2100	Before 440000	PCAK004	\$ 442.00
2100	440000 - Up	PCAK005	\$ 442.00
2110	ALL	PCAK005	\$ 442.00
9960 & 9970	ALL	*PCAK006	\$1,017.00

***This kit is oversized - Regular shipping + \$50.00**

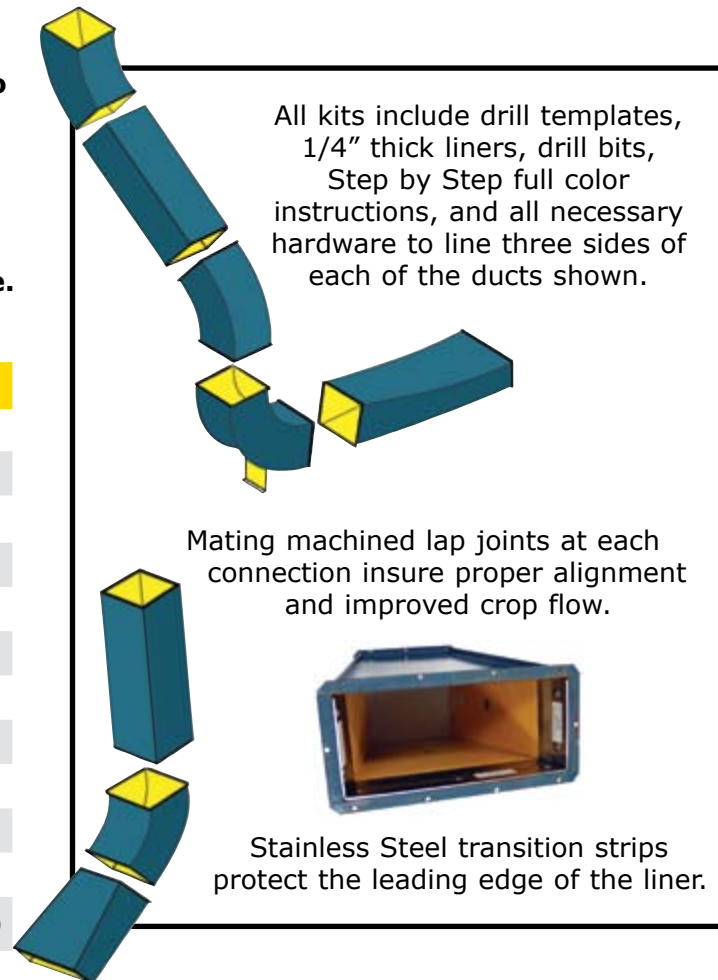

All kits include drill templates, 1/4" thick liners, drill bits, Step by Step full color instructions, and all necessary hardware to line three sides of each of the ducts shown.

Mating machined lap joints at each connection insure proper alignment and improved crop flow.

Stainless Steel transition strips protect the leading edge of the liner.



PEANUT

1/4" POLY LINERS FOR KMC PEANUT COMBINES

- Twice as thick as the original 1/8" liners.
- Countersunk bolts improve crop flow.
- Improved fastening system allows liner to expand and contract without warping.

KMC POLY LINER KITS

Kit #	Description	Price
PCKK001	4 & 6 Row Wide Body 1994 to present 4 panels with hardware - air lift side only. STANDARD (PCKL342, PCKL300, PCKL270, PCKL301)	\$322.00
PCKK002	4 & 6 Row Wide Body 1994 to present with Tank Lift Option (High Capacity Tank) 4 panels with hardware - air lift side only. TALL (PCKL342, PCKL300, PCKL270, PCKL443)	\$333.00
PCKK003	Fan Housing Kit - 4 & 6 Row Wide Body 1994 to 2005 3 panels with hardware (2-PCKL253, 1-PCKL252)	\$73.00
PCKK004	Fan Housing Kit - 4 & 6 Row Wide Body 2006 to Present 3 panels with hardware (PCKL974, PCKL975, PCKL976)	\$85.00



PCKK003
1994-2005

PCKK004
2006-Present



Model #	Replaces OEM # 1994-2010	Replaces OEM # 2011-Present	Description	Price
PCKL270	33-028-270	33-050-433	Liner, Access Door	\$ 46.00
PCKL300	33-028-300	33-050-434	Liner, Top Duct	\$ 98.00
PCKL301	33-028-301	33-050-435	Liner, Bottom Duct	\$127.00
PCKL342	33-028-342	33-050-436	Liner, Peanut Elbow	\$ 99.00
PCKL443	33-028-443	33-050-438	Liner, Bottom Duct - Tall	\$115.00
PCKL338	33-028-338	33-028-338	Liner, Air Lift Fan Elbow Duct	\$104.00
PCKL252	33-028-252		Liner, Air Lift Fan Lower - Fits 1994 to 2005	\$ 14.50
PCKL253	33-028-253		Liner, Air Lift Fan (2 required) - Fits 1994 to 2005	\$ 33.50
PCKL974		33-028-974	Liner, Air Lift Fan Lower - Fits 2006 to Present	\$ 14.50
PCKL975		33-028-975	Liner, Air Lift Fan Front - Fits 2006 to Present	\$ 32.00
PCKL976		33-028-976	Liner, Air Lift Fan Rear - Fits 2006 to Present	\$ 39.00

POLY LAST™ PICKER DOOR COVERS

COTTON



Poly Last™ picker door covers can outwear originals by more than 2-1!

Born in the bootheel of Missouri and raised in Georgia, Poly Last™ picker accessories are the finest available for your Case or John Deere picker. Some of the first picker door covers were built in the bootheel of Missouri by two of the best picker mechanics anywhere. They were looking for ways to get the most out of their customers machines and Poly Last™ Yellow covers were one answer. Poly Tech eventually brought the idea home and honed it into the kits we sell today.

Over the past several years Poly Tech has made several improvements over that original design. We've relocated and reduced the number of fasteners for easier installation.

The success of the Poly Last™ kits has spawned many "me too" companies trying to take advantage of it. Most offer a thin, white material that won't hold up in sunlight or under stress and is too thin to allow for countersunk holes. Rivet heads wear and pull out and the material cracks or breaks. Encountering such problems when you need to be picking cotton can be a nightmare. The picture on the right shows what can happen when you try to save a few bucks with the "me too" brand.

Our pressure door covers are built from full 1/4" Poly Last™. A name you can trust. We even offer yellow or red for your picker of choice. Rivets are countersunk for protection and placed out of spindle path. Beveled leading edges minimize the chance of anything getting behind covers.

If you're thinking of updating your picker or just need to replace some worn out parts, look carefully at our Poly Last™ products. You'll find some of the most cost effective parts you can buy. An important consideration in today's tight market. If you don't agree, return them. They're covered by the Poly Tech "No Hassle Guarantee".



- 1/4" Poly Last™ material for long life.
- No spark if Poly Last™ is hit by spindles.
- Preformed to fit the contour of your steel.
- Countersunk mounting holes protect rivets.
- Hole pattern keeps rivets away from spindles.
- Beveled leading edge for smooth crop flow.
- Exclusive "No Hassle Guarantee."

**DON'T LET THIS HAPPEN TO YOU.
INSIST ON POLY LAST™!**

POLY LAST™ PICKER DOOR COVERS

POLY/STEEL DOORS HAVE BEEN DISCONTINUED.

Poly Last™ picker door kits for John Deere Pickers contain two different components. A preformed, pre-drilled and countersunk 1/4" Poly Last™ cover fits the steel door. The factory .090" poly extension is replaced with full 1/8" poly. The heavier gauge extensions resist warping better than the factory poly. All kits include hardware and instructions.



JOHN DEERE 9910

Part #	Steel #	Description	Price
APJP538	AN114538	Front Door "High Drum"	\$132.00
APJP125	AN115125	Front Door "Low Drum"	\$118.00
APJP494	N198494	Front Extension "High Drum"	\$ 22.00
APJP533	N119533	Front Extension "Low Drum"	\$ 18.00
APJP977	AN114977	Rear Door "High Drum"	\$ 94.00
APJP128	AN115128	Rear Door "Low Drum"	\$ 84.00
APJP495	N198495	Rear Extension "High Drum"	\$ 29.00
APJP575	N119575	Rear Extension "Low Drum"	\$ 21.00
ASJP9910		Full Row Kit "High Drum"	\$249.30
ASJP9910L		Full Row Kit "Low Drum"	\$216.90

JOHN DEERE 9920

Part #	Steel #	Description	Price
APJP370	AN190370	Front Door "High Drum"	\$132.00
APJP371	AN190371	Front Door "Low Drum"	\$118.00
APJP494	N118221	Front Extension "High Drum"	\$ 22.00
APJP533	N119533	Front Extension "Low Drum"	\$ 18.00
APJP977	AN114977	Rear Door "High Drum"	\$ 94.00
APJP128	AN115128	Rear Door "Low Drum"	\$ 84.00
APJP495	N198495	Rear Extension "High Drum"	\$ 29.00
APJP575	N119575	Rear Extension "Low Drum"	\$ 21.00
ASJP9920		Full Row Kit "High Drum"	\$249.30
ASJP9920L		Full Row Kit "Low Drum"	\$216.90

JOHN DEERE 9930

Part #	Steel #	Description	Price
APJP370	AN190370	Front Door "High Drum"	\$132.00
APJP371	AN190371	Front Door "Low Drum"	\$118.00
APJP494	N198494	Front Extension "High Drum"	\$ 22.00
APJP533	N119533	Front Extension "Low Drum"	\$ 18.00
APJP157	AN192157	Rear Door "High Drum"	\$ 97.00
APJP321	AN192321	Rear Door "Low Drum"	\$ 84.00
APJP495	N198495	Rear Extension "High Drum"	\$ 29.00
APJP575	N119575	Rear Extension "Low Drum"	\$ 21.00
ASJP9930		Full Row Kit "High Drum"	\$252.00
ASJP9930L		Full Row Kit "Low Drum"	\$216.90

JOHN DEERE 9940

Part #	Steel #	Description	Price
APJP370	AN190370	Front Door	\$132.00
APJP494	N198494	Front Extension	\$ 22.00
APJP977	AN114977	Rear Door	\$ 94.00
APJP495	N198495	Rear Extension	\$ 29.00
ASJP9940		Full Row Kit	\$249.30

POLY LAST™ PICKER DOOR COVERS

JOHN DEERE 9950

Part #	Steel #	Description	Price
APJP370	AN190370	Front Door	\$132.00
APJP494	N198494	Front Extension	\$ 22.00
APJP157	AN192157	Rear Door	\$ 97.00
APJP495	N198495	Rear Extension	\$ 29.00
ASJP9950		Full Row Kit	\$249.30

JOHN DEERE 9960/65c

Part #	Steel #	Description	Price
APJP370	AN190370	Front Door	\$132.00
APJP494	N198494	Front Extension	\$ 22.00
APJP157	AN192157	Rear Door	\$ 97.00
APJP495	N198495	Rear Extension	\$ 29.00
ASJP9960		Full Row Kit	\$252.00

JOHN DEERE 9970/76/86 "AGGRESSIVE" DOOR

Part #	Steel #	Description	Price
APJP558	AN279558	9976/86 Front Door Pro-16 "AGGRESSIVE" Rear Door w/Stripper Plates	\$150.00
APJP558R	AN279558	9976/86 Rear Door Pro-16 "AGGRESSIVE" w/o Stripper Plates	\$150.00
APJP557	AN279557	9970 Front Door Pro-12 "AGGRESSIVE" Rear Door w/Stripper Plates	\$134.00
APJP557R	AN279557	9970 Rear Door Pro-12 "AGGRESSIVE" w/o Stripper Plates	\$134.00

SAVE 10 %
Full row kit price reflects a 10% discount vs. individually priced parts.



JOHN DEERE PICKER SHOE

PART # ACPJ.....\$21.00/pair

PART # ACPJ420...\$21.00/pair (fits steel #N377420)

JOHN DEERE 9960/65i

Part #	Steel #	Description	Price
APJP029	AN193029	Front Door	\$110.00
APJP126	N196126	Front Extension	\$ 36.00
APJP029	AN193029	Rear Door	\$110.00
APJP126	N196126	Rear Extension	\$ 36.00
ASJP9961		Full Row Kit	\$262.80

JOHN DEERE 9935/70/76/86

Part #	Steel #	Description	Price
APJP593	AN274593	9976/86 Front Door Pro-16 20S Rear Door w/ Stripper Plates	\$145.00
APJP593R	AN274593	9976/86 Rear Door Pro-16 20S w/o Stripper Plates	\$145.00
APJP104	N274104	9976/86 Front/Rear Extension Pro-16 20S	\$ 37.00
APJP587	AN274587	9970 Front Door Pro-12 18S Rear Door w/ Stripper Plates	\$130.00
APJP587R	AN274587	9970 Rear Door Pro-12 18S w/o Stripper Plates	\$130.00
APJP108	N274108	9970 Front/Rear Extension Pro-12 18S	\$ 33.00
ASJP9976		9976/86 Full Row Kit	\$314.10
ASJP9970		9970 Full Row Kit	\$306.90

Note: Please advise if you are running stripper plates on your rear doors.

Hammer Rivet Installation Tool

Handle is made of shock resistant rubber to protect hands. Allows poly to be pressed into contact with steel during installation for a tighter fit. Straight handle design allows for greater control of tool: Does not rock or bounce. Dimensions: 2 1/2" x 5 3/4"



PART# AHRT.....\$21.95

POLY LAST™ PICKER DOOR COVERS

POLY/STEEL DOORS HAVE BEEN DISCONTINUED.



Non-Spark Surface



CASE IH 1822

Part #	Steel #	Description	Price
RIGHT DRUM			
APCP527	216527C1	Front Guide Right Drum	\$ 69.00
APCP247	1266247C1	Rear Guide Right Drum	\$ 56.00
APCP532	216532C1	Front Extension Right Drum	\$104.00
APCP532	216532C1	Rear Extension Right Drum	\$104.00
ASCP1822R		Full Row Kit Right Drum	\$299.70
LEFT DRUM			
APCP526	216526C1	Front Guide Left Drum	\$ 69.00
APCP399	1278399C1	Rear Guide Left Drum	\$ 56.00
APCP532	216532C1	Front Extension Left Drum	\$104.00
APCP532	216532C1	Rear Extension Left Drum	\$104.00
ASCP1822L		Full Row Kit Left Drum	\$299.70

CASE IH 1844

Part #	Steel #	Description	Price
DRUM 1 OR 3 (RIGHT)			
APCP527	216527C1	Front Guide Drum 1 or 3	\$ 69.00
APCP247	1266247C1	Rear Guide Drum 1 or 3	\$ 56.00
APCP532	216532C1	Front Extension Drum 1 or 3	\$104.00
APCP532	216532C1	Rear Extension Drum 1 or 3	\$104.00
ASCP1844R		Full Row Kit Drum 1 or 3	\$299.70
DRUM 2 OR 4 (LEFT)			
APCP526	216526C1	Front Guide Drum 2 or 4	\$ 69.00
APCP399	1278399C1	Rear Guide Drum 2 or 4	\$ 56.00
APCP532	216532C1	Front Extension Drum 2 or 4	\$104.00
APCP532	216532C1	Rear Extension Drum 2 or 4	\$104.00
ASCP1844L		Full Row Kit Drum 2 or 4	\$299.70

CASE 2022/24

Part #	Steel #	Description	Price
DRUM 1 OR 3 (RIGHT)			
APCP337	1546337C2	Front Guide Drum 1 or 3	\$110.00
APCP345	1546345C2	Rear Guide Drum 1 or 3	\$100.00
APCP340	1546340C1	Front Extension Drum 1 or 3	\$137.00
APCP348	1546348C1	Rear Extension Drum 1 or 3	\$122.00
ASCP2022R		Full Row Kit Drum 1 or 3	\$422.10
DRUM 2 OR 4 (LEFT)			
APCP336	1546336C2	Front Guide Drum 2 or 4	\$110.00
APCP344	1546344C2	Rear Guide Drum 2 or 4	\$100.00
APCP340	1546340C1	Front Extension Drum 2 or 4	\$137.00
APCP348	1546348C1	Rear Extension Drum 2 or 4	\$122.00
ASCP2022L		Full Row Kit Drum 2 or 4	\$422.10

CASE 2055

Part #	Steel #	Description	Price
APCP337	1546337C1	Front Guide (Right Hand)	\$110.00
APCP340	1546340C1	Front Extension	\$137.00
APCP345	1546345C1	Rear Guide (Right Hand)	\$100.00
APCP348	1546348C1	Rear Extension	\$122.00
ASCP2055		Full Row Kit	\$422.10

CASE 2155

Part #	Steel #	Description	Price
APCP337	1546337C1	Front Guide (Right Hand)	\$110.00
APCP340	1546340C1	Front Extension	\$137.00
APCP345	1546345C1	Rear Guide (Right Hand)	\$100.00
APCP348	1546348C1	Rear Extension	\$122.00
ASCP2155		Full Row Kit	\$422.10

CASE 2555 (below serial #JJCO249501)

Part #	Steel #	Description	Price
APCP337	1546337C1	Front Guide (Right Hand)	\$110.00
APCP340	1546340C1	Front Extension	\$137.00
APCP345	1546345C1	Rear Guide (Right Hand)	\$100.00
APCP348	1546348C1	Rear Extension	\$122.00
ASCP2555		Full Row Kit	\$422.10

CASE CPX610 & 2555

(2555 after serial #JJCO249500)

Part #	Steel #	Description	Price
APCP695	442695A1	Front Guide	\$110.00
APCP985	404985A2	Front Extension	\$137.00
APCP696	442696A1	Rear Guide	\$100.00
APCP250	434250A1	Rear Extension	\$122.00
ASCP610		Full Row Kit	\$422.10

CASE IH PICKER SHOE COVERS

Part #	Description	Price
ACPC100	Poly Tech Metal Skid replaces smaller factory skid. Bigger footprint for better sensing in wet sticky conditions.	\$60.00 pr.
ACPC150	Poly Last™ Wide Cover - Non-Stick cover for our wide shoe (8" @ widest point). Also fits Case factory wide shoe.	\$42.00 pr.
ACPC155	Poly Last™ Standard Cover - Non-Stick longer wearing cover for factory narrow (standard 5" @ widest point) shoe.	\$39.00 pr.

CASE 625/635 MODULE EXPRESS

Part #	Description	Price
APCP915FF	Front Door Front Half	\$110.00
APCP915FR	Front Door Rear Half	\$100.00
APCP915E	Front Extension	\$35.00
APCP916R	Rear Door	\$137.00
APCP916E	Rear Extension	\$17.50
ASCP625	Full Row Kit	\$457.10

CASE IH REPLACEMENT SHOES

Part #	Description	Price
ACPC500	1/2" Case Picker Shoe Kit includes everything you need to convert to 1/2" Poly Shoes	\$88.00
ACPC520	1/2" Case Picker Shoes (poly only) Replace worn shoes in minutes without lifter disassembly.	\$67.00

MISCELLANEOUS

625/635 MODULE EXPRESS SENSING SHOE

ACPC625PP.....\$9.59 each

This gray skid shoe helps to pick low hanging bolls and prevent plowing dirt build up. Covers Aimtrac part #84258393.

HIGH PERFORMANCE PICKING PRESSURE DOOR BUSHING FOR CASE CPX610

ACPC610.....\$11.50 each



TRASH KNOCKER

ACPC205.....\$3.70 each

Mounted at the bottom of the bar ("stool area"), this device helps prevent buildup and reduces wear in the cabinet area.

PRESSURE DOOR BUSHING

ACPC210.....\$4.00 each

Special nylon bushing installs in top and bottom of door pivot to eliminate wear that can lead to lost doors.

POP RIVETS (SMALL HEAD)

Part#	Description	Price
AH105	3/16" Dia. x 1/4" Grip Pop Rivet	\$12.60 / 100
AH110	3/16" Dia. x 3/8" Grip Pop Rivet	\$13.65 / 100
AH175	3/16" Dia. x 1/2" Grip Pop Rivet	\$14.70 / 100

POP RIVETS (LARGE HEAD)

Part#	Description	Price
AH100	3/16" Dia. x 3/8" Grip Pop Rivet	\$14.70 / 100
AH120	3/16" Dia. x 5/8" Grip Pop Rivet	\$16.80 / 100
AH180	3/16" Dia. x 3/4" Grip Pop Rivet	\$18.90 / 100

HAMMER RIVETS (SMALL HEAD)

Part#	Description	Price
AH170	3/16" Dia. x 3/8" Grip Hammer Rivet	\$28.00 / 100
AH151	1/4" Dia. x 1/4" Grip Hammer rivet	\$22.05 / 100

HAMMER RIVETS (LARGE HEAD)

Part#	Description	Price
AH150	1/4" Dia. x 1/4" Grip Hammer Rivet	\$27.30 / 100
AH140	1/4" Dia. x 3/8" Grip Hammer Rivet	\$29.40 / 100

NO.1 ELEVATOR BOLT

Part#	Description	Price
AH190	1/4" - 20 x 3/4" Elevator Bolt	\$ 6.80 / 25
AH191	1/4" - 20 x 1" Elevator Bolt	\$ 7.35 / 25
AH1105	1/4" - 20 x 1 1/4" Elevator Bolt	\$ 7.85 / 25
AH200	3/8" - 16 x 2" Elevator Bolt	\$18.90 / 25

FANGED ELEVATOR BOLT

Part#	Description	Price
AH191F	1/4" - 20 x 1" Fanged Elevator Bolt	\$ 9.20 / 25
AH1105F	1/4" - 20 x 1 1/4" Fanged Elevator Bolt	\$ 9.45 / 25
AH1100	5/16" - 18 x 1 1/4" Fanged Elevator Bolt	\$12.60 / 25

NO.3 RELIANCE BOLT

Part#	Description	Price
AH1000	1/4" - 20 x 3/4" #3 Reliance Bolt	\$ 7.35 / 25
AH1001	1/4" - 20 x 1" #3 Reliance Bolt	\$ 9.20 / 25
AH1300	1/4" - 20 x 1 1/4" #3 Reliance Bolt	\$ 9.20 / 25
AH125	5/16" - 18 x 1" #3 Reliance Bolt	\$10.50 / 25
AH1200	5/16" - 18 x 1 1/4" #3 Reliance Bolt	\$11.00 / 25



NO. 3 PLOW BOLT

Part#	Description	Price
AH225	3/8" - 16 x 1 1/2" #3 Plow Bolt	\$ 6.60 / 25
AH971	3/8" - 16 x 2 1/2" #3 Plow Bolt	\$10.00 / 25
AH400	7/16" - 14 x 1 3/4" #3 Plow Bolt	\$16.80 / 25

CLIP HEAD BOLT

Part#	Description	Price
AH600	7/16" - 14 x 1 3/4" Clip Head Bolt	\$12.75 / 25
AH675	1/2" - 13 x 1 1/2" Clip Head Bolt	\$17.30 / 25

NYLON INSERTED LOCK NUTS

Part#	Description	Price
AH986	8 - 32 Nyloc Nut	\$ 8.40 / 100
AH990	10 - 24 Nyloc Nut	\$ 8.40 / 100
AH196	1/4" - 20 Nyloc Nut	\$ 9.45 / 100
AH942	5/16" - 18 Nyloc Nut	\$13.65 / 100
AH625	7/16" - 14 Nyloc Nut	\$14.70 / 100
AH750	1/2" - 13 Nyloc Nut	\$15.75 / 100

FLANGE NUTS

Part#	Description	Price
AH994	1/4" - 20 Flange Nut	\$ 6.30 / 100
AH1103	5/16" - 18 Flange Nut	\$ 9.45 / 100
AH229	3/8" - 16 Flange Nut	\$12.60 / 100
AH231	1/2" - 13 Flange Nut	\$27.30 / 100

135° SPLIT POINT STUB DRILLS

Part#	Description	Price
AHDB125	1/8" Drill Bit	\$1.55
AHDB203	13/64" Drill Bit	\$1.60
AHDB265	17/64" Drill Bit	\$2.60
AHDB280	9/32" Drill Bit	\$3.15
AHDB344	11/32" Drill Bit	\$5.10
AHDB375	3/8" Drill Bit	\$5.70
AHDB438	7/16" Drill Bit	\$6.30

SELF DRILLING SCREWS

Part#	Description	Price
AH999	#10 x 3/4" Self Drilling Screw	\$ 8.40 / 100



Hammer Rivet Installation Tool

Handle is made of shock resistant rubber to protect hands. Allows poly to be pressed into contact with steel during installation for a tighter fit. Straight handle design allows for greater control of tool: Does not rock or bounce.



Dimensions: 2 1/2" x 5 3/4"

PART# AHRT.....\$21.95

HITCH SAVERS

POLY SHEETS & ROLLS

Part #	Description	Price
HSP60100	3/8" X 6" O.D. X 1" I.D.	\$6.00
HSP60125	3/8" X 6" O.D. X 1 1/4" I.D.	\$6.00
HSP60150	3/8" X 6" O.D. X 1 1/2" I.D.	\$6.00
HSP60175	3/8" X 6" O.D. X 1 3/4" I.D.	\$6.00
HSP60200	3/8" X 6" O.D. X 2" I.D.	\$6.00
HSP60250	3/8" X 6" O.D. X 2 1/2" I.D.	\$6.00
HSP60275	3/8" X 6" O.D. X 2 3/4" I.D.	\$6.00
HSP50100	3/8" X 5" O.D. X 1" I.D.	\$6.00
HSP50125	3/8" X 5" O.D. X 1 1/4" I.D.	\$6.00
HSP50150	3/8" X 5" O.D. X 1 1/2" I.D.	\$6.00
HSP50175	3/8" X 5" O.D. X 1 3/4" I.D.	\$6.00
HSP50200	3/8" X 5" O.D. X 2" I.D.	\$6.00
HSP50250	3/8" X 5" O.D. X 2 1/2" I.D.	\$6.00
HSP50275	3/8" X 5" O.D. X 2 3/4" I.D.	\$6.00
HSP51100	1/2" X 5" O.D. X 1" I.D.	\$8.00
HSP51125	1/2" X 5" O.D. X 1 1/4" I.D.	\$8.00
HSP51150	1/2" X 5" O.D. X 1 1/2" I.D.	\$8.00
HSP51175	1/2" X 5" O.D. X 1 3/4" I.D.	\$8.00
HSP51200	1/2" X 5" O.D. X 2" I.D.	\$8.00
HSP51250	1/2" X 5" O.D. X 2 1/2" I.D.	\$8.00
HSP51275	1/2" X 5" O.D. X 2 3/4" I.D.	\$8.00

**YELLOW / GREY / RED / GREEN
POLY LAST™ SHEETS**

Light weight • Non-stick surface
Moisture resistant • Chemical resistant
Added UV Resistance • Low coefficient of friction
High impact and abrasion resistance

Part #	Description	Price
AY1848120	1/8" x 48" x 120" Poly Last	\$147.00
AY1448120	1/4" x 48" x 120" Poly Last	☹ \$294.00
AY3848120	3/8" x 48" x 120" Poly Last	☹ \$430.50

BLACK ECO POLY LAST™ SHEET

Light weight • Non-stick surface • Economical price
Moisture resistant • Chemical resistant
Low coefficient of friction • High impact resistance
Medium/high abrasion resistance

Part #	Description	Price
AG1448120	1/4" x 48" x 120" Black Eco	☹ \$283.50
AG3848120	3/8" x 48" x 120" Black Eco	☹ \$393.75

☹ Items with this symbol are truck ship only.

WHITE ROLLED POLY SHEET

Durable • Low maintenance • Non-rusting or rotting
Rodent resistant • Long life - won't chip or break
Easy to clean • Nonporous finish • Neutral bacterial environment
Unaffected by most cleaners

Great for hog, dairy, poultry building & equipment applications

NON-STOCKING ITEM

Part #	Description	Roll Price	/Ft. Price
ARP182450	1/8" x 24" x 50'	☹ \$ 239.50	\$ 4.79
ARP183050	1/8" x 30" x 50'	☹ \$ 298.70	\$ 5.97
ARP184850	1/8" x 48" x 50'	☹ \$ 476.40	\$ 9.52
ARP3163650	3/16" x 36" x 50'	☹ \$ 553.65	\$11.07
ARP3164850	3/16" x 48" x 50'	☹ \$ 736.45	\$14.72
ARP3169650	3/16" x 96" x 50'	☹ \$1900.00	\$38.00

These are the most commonly used sizes of rolled poly stocked by the manufacturer. The same material is also available in other sizes up to 100' in length. For price and delivery please call.

The following cutting charges apply to all orders:
Up to 48" Wide: \$10
60" to 72" Wide: \$20
96" Wide: \$25

PLEASE CALL FOR PRICING ON CUT PIECES.





TrackMat

This knee-saving 2'x4' foldable mat is a plush yet ultra-tough 3/4" thick foam pad fused with 100% polypropylene fibers. Stain, oil and chemical resistant, the TrackMat can withstand whatever you throw at it while effortlessly providing convenience and comfort. It's made of a similar material to that used in lifejackets, so it won't retain water and can't mold or mildew. Use it as a pad to kneel on or as a lightweight and portable creeper to keep you comfortable and clean while you work.

Part #: BR2X4PT.....\$29.00



Eight layers of thermally bonded 100% polypropylene make PIG Mat the strongest on the market. Won't rip, tear or fray even when saturated!

PIG® Universal Absorbent Mat Tablet® Pack

14" x 15" - 15 Universal light weight tear-off mat pads on a tablet. Absorbs up to 1 gallon per tablet.

Part #: 25101.....\$12.95

PIG® Universal Absorbent Mat Roll

15" x 50'L - Light weight roll. Absorbs coolants, oils, water & solvents! Absorbs up to 3 gallons per roll.

Part #: 25201.....\$21.99

PIG® Universal Absorbent Mat Pack

15" x 20" - (3) Universal medium weight pads per package. Absorbs up to 1/2 gallon per pack.

Part #: 25306.....\$4.96



PIG® Form-A-Funnel® Flexible Draining Tool

Easily molds, then holds its shape so you get every last drop of oil every time, no matter how obstructed the filter or plug. 16 1/2" x 14 1/2".

Part #: TLS706-GR.....\$19.99



PIG® Spill Kit in See-Thru Bag

Economical spill kit - packed in a clear bag for easy inspection. Compact kit with zipper closure is ideal for outfitting a vehicle fleet. PIG BLUE Socks stop spreading spills. PIG Mat absorbs quickly. Temporary disposal bags help make clean-up easier. Transparent bag lets you check supply levels at a glance while keeping contents clean and dry. Absorbs up to 5 gallons.

Part #: KIT274.....\$50.00



PIG Water-Repellent Mat safely absorbs and retains oils and oil-based liquids, lubricants and fuels while repelling water; floats to clean up spills on water!

PIG® Water-Repellent Oil-Absorbent Mat Rolls

15" x 50'L - Light weight roll. Absorbs only oil based liquids and repels water based liquids. Absorbs up to 3 gallons per roll.

Part #: 26201.....\$21.99

www.polyskid.com

Have a question? Need more information? - Visit our website 24/7 where you will find pricing, additional information, and instructions for our Poly Last™ products. We have listed our contact information and created a direct email link so you can email or fax your inquiries and orders or request a catalog.

1.800.542.7659 or 1.706.468.2801

PHONE ORDERS - Our normal office hours are 8:00 am to 5:00 pm ET Monday - Friday. These hours may be extended during planting and harvest seasons, please call to verify. Please have credit card or account information ready to give to your customer service representative. Your account will not be charged until the order is shipped.

1.706.468.2881

FAX ORDERS - For Credit Card, C.O.D. and orders on Account you may fax your order 24 hours a day, 7 days a week. Orders received after 5:00 pm Eastern or on Fridays or Holidays will be processed the next business day. Please fill out sales order (sales orders available on request by fax) and fax to: 1-706-468-2881.

RETURNS - Items Not covered by our "No Hassle Guarantee" are subject to inspection upon return. If found to be in resalable condition we will issue a credit or return your money - less a 20% restocking fee. To return items covered by our "No Hassle Guarantee", please call customer service at 1-800-448-7659 or write for a Return Authorization Number within 12 months of invoice date. No return will be processed without a Return Authorization Number. Custom Orders are not returnable in most cases.

DEALERS - Net 30 days with approved credit. Dealer pays actual shipping charges. Take discounts before freight charges are added. Call for Dealer programs.

SERVICE CHARGE - A Service charge of 1 1/2% per month will be applied to all unpaid balances over 30 days.

PRICES - Subject to change without notice. All shipments F.O.B. Origin unless prior arrangements made with Poly Tech.

SHIPPING - Place your order for any stock ground shippable product by Noon Eastern time and we will make every effort to ship it the same day. Place your order for any stock ground shippable product after Noon Eastern and we will make every effort to ship it by the next business day.

STANDARD GROUND SHIPPING CHARGES

Total \$ Value of Order	UPS Shipping & Handling	Total \$ Value of Order	UPS Shipping & Handling
Orders to \$ 30.99	\$ 6.00	\$151.00 - \$200.99	\$28.50
\$ 31.00 - \$ 60.99	\$ 8.50	\$201.00 - \$250.99	\$32.40
\$ 61.00 - \$ 90.99	\$16.50	\$251.00 - \$300.00	\$36.20
\$ 91.00 - \$120.99	\$21.00	Over \$300.00	\$39.50
\$121.00 - \$150.99	\$24.50	C.O.D. Charge	\$10.50



SHIPPING FROM OUR MINNESOTA WAREHOUSE

To provide you with faster delivery and lower freight costs, your orders can be shipped from our warehouse located in Gibbon, Minnesota.

NO HASSLE GUARANTEE

Poly Tech Guarantees for one full year from the date of purchase that our products

- Perform as designed
- Save you time and money
- Meet your expectations

Or we will gladly arrange a refund or an exchange, whichever you prefer.



FULL SERVICE AG

How may we help you?

- Improve your equipment efficiencies
- Lessen your downtime during harvest
- Reduce wear on your combine parts
- Lower your maintenance costs



Is there anything else we can do for you?

Full service ag at Poly Tech is not an object of the past like the full service gas stations. We do not compromise the quality of our products or reputation of our customer service. These family values and traditions run deep in our heritage as we continue to:

- Expand our product line
- Research equipment related needs
- Add dealers to increase our scope of service
- Stock product for immediate availability
- Communicate with our customers

**At Poly Tech Our Goal Is:
TOTAL CUSTOMER SATISFACTION**

800.542.7659

Call Toll-Free Today or

Visit Us Online @ POLYSKID.com

Poly Tech Industries
PO Drawer 349
238 Industrial Park Dr.
Monticello, GA 31064