



EasyCut B

Mower combinations





EasyCut B

KRONE mower combinations for maximum efficiency

- EasyCut B 870 and B 1000 without conditioner
- EasyCut B 750, B 890, B 970 without conditioner
- EasyCut B 950 Collect without conditioner, with merger augers
- EasyCut B 870 CV and B 1000 CV with steel tine conditioner
- EasyCut B 870 CR and B 1000 CR with roller conditioner
- EasyCut B 870 CV Collect and 870 CR Collect, B 1000 CV Collect and B 1000 CR Collect with merger belts



- KRONE quick-change blades
- **KRONE SafeCut:**
Individually protected discs
- **KRONE SmartCut:**
Stripe-free cutting
- **KRONE CombiFloat:**
Uniform ground pressure across the entire work width
- Operator comfort to the max



The EasyCut cutterbar	4
The quick-change blade system	8
The SafeCut cutterbar protection system	10
The DuoGrip suspension	12
The steel tine conditioner CV	14
The roller conditioner	12
The Collect system	18
EasyCut B 870 and B 1000	20
EasyCut B 750, B 890, B 970	26
EasyCut B 950 Collect	32
EasyCut B 870 CV, B 870 CR	38
EasyCut B 1000 CV, B 1000 CR	40
EasyCut B 870/1000 CV Collect B 870/1000 CR Collect	46
Operation	48
The EasyCut front mower to match	50
Protecting wildlife	52
Technical Data	54



The KRONE cutterbar

- Fully welded: Robust, sealed and permanently lubricated
- The durable satellite drives have massive spur gears for quiet running and superior efficiency
- No inner shoe for trouble-free cutting

The enclosed and fully welded cutterbar meets the highest quality standards and operates dependably and leak-free over many years of hard work. Massive and oil-immersed spur gears impress by very quiet and reliable running in sustained peak-load operation.



No inner shoe

The cutterbar is driven by the right-angle gearbox just behind the inner top hat for blockage-free operation on the headland and in awkwardly shaped fields.

The original

Developed by KRONE, the established satellite drive has proven extremely well all over the world for so many years. Its massive spur gears with up to 59 teeth transmit the drive power down to the very last disc. The large-diameter gears rotate at reduced speeds, with a higher number of teeth

meshing with the neighbouring gearwheels for even quieter running, ultimate efficiency and maximum longevity. Each disc is driven by its individual auxiliary gear which minimises the load on the disc.

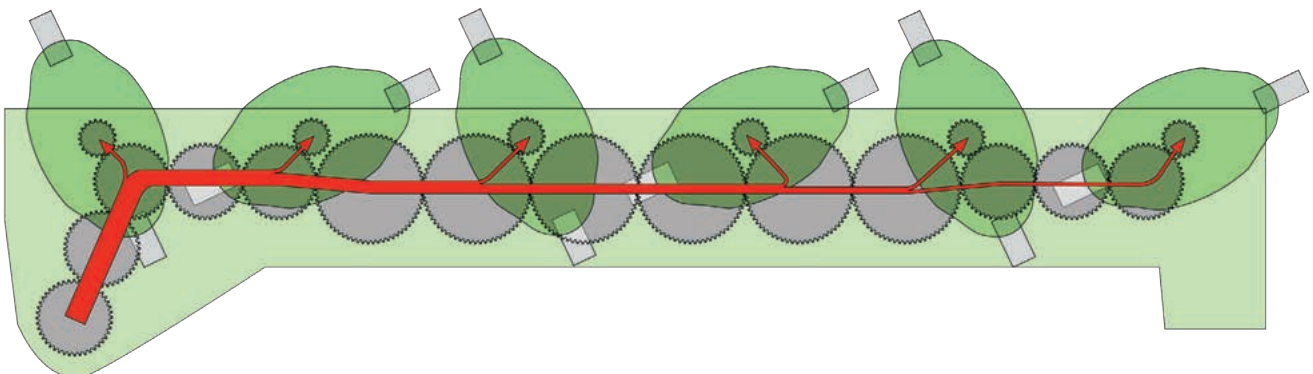



Leak-proof and robust

Using welding robots and CNC technology, KRONE manufactures its cutterbars to the highest quality standards, ensuring they are fully welded and permanently lubricated. After all, the cutterbar is the heart of every disc mower.

Permanently lubricated

The completely welded cutterbar is maintenance free and won't leak nor lose shape even in so many years of work. We give it special cleanings throughout the manufacturing process so we can implement permanent lubrication and eliminate the need for oil changes.





KRONE **SmartCut** for a **perfect spread**

Making clean cuts and spreading or swathing to needs

- The wedge-shaped cutterbar guarantees clean cuts
- Heavy-duty spur gears run in double bearings. Widely spaced bearings.
- Swathing or spreading depending on needs

The wedge-shaped cutterbar offers great flexibility to adjust through a large range of settings and leave a short stubble in meadows and pastures as well as long stubble in long-stemmed field crops. An EasyCut mower delivers a reliable performance and clean cut.

Heavy-duty and flexible

The wedge-shaped cutterbar offers many height setting options. The spur gears run in massive double bearings, allowing the cutterbar to handle extremely high loads.

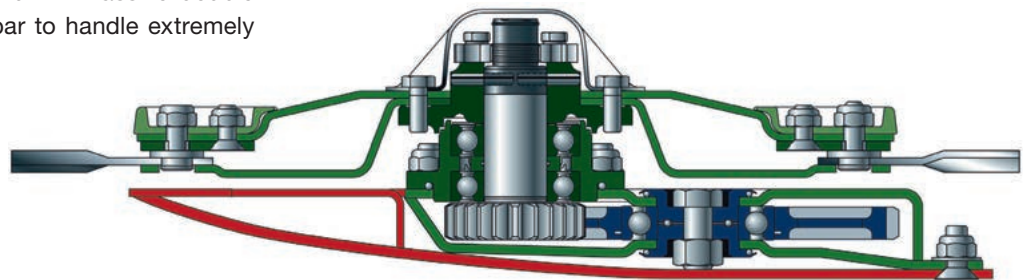

SmartCut

With some discs turning in pairs towards each other and others turning away from each other, it was necessary to redesign the degree of blade overlap to ensure cleanest cuts. For stripeless cuts in light and young crops, we have therefore

increased blade overlaps on the discs turning outwards. In addition, the blades turning to the rear are set further apart to encourage a smooth flow of large volumes of crop.

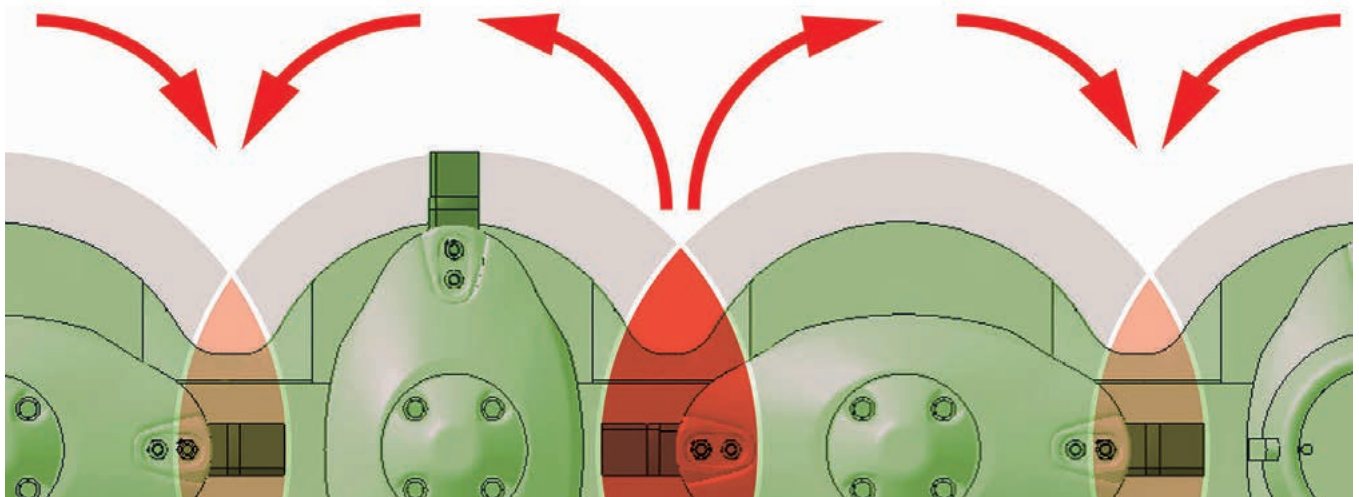



Convenient

The spur gears are arranged in a forward position and eccentrically inside the gearbox right under the discs. The small auxiliary spur gears are removed from above, the massive main gears gearbox from the side.

Swathing

Spinning inwards, the discs feed the material to the middle of the machine to avoid tractor wheels running over the cut crops. With discs spinning in the A sense of rotation, EasyCut B 750 and EasyCut B 890 form one swath. The EasyCut B 970 and EasyCut B 1000 can form double swaths.

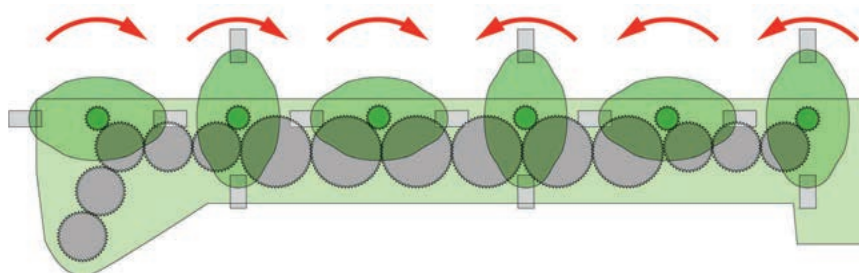

No swathing

With discs spinning in the B sense of rotation, EasyCut spreads the material across the full cutting width. All discs turn in pairs, spreading the material across the working width for faster and more uniform wilting.

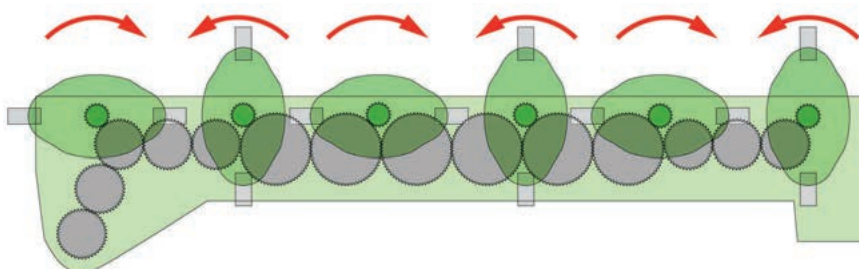



The KRONE quick-change blade system

- Quick-change blades are standard specification, allowing operators to swap blades in the field quickly
- Modular disc design
- Minimum blade wear: 360° blade action
- Excellent cuts from **SmartCut**: Optimum blade overlap

There are many reasons for choosing an EasyCut disc mower. Just think of the quick-change blades, the inexpensive wear parts and the perfect disc arrangement for stripeless cuts.



Changing blades in an instant

Quick-change blades are a must for many farmers and contractors. These blades are quick and easy to reverse or replace in situ.

Hovering over the sward

Made from hardened steel, the extra wide skids reduce the ground pressure and hence offer effective protection of both the cutterbar and the sward. The skids are bolted to the cutterbar so they are easy to replace.



Making higher cuts

High-cutting skids are the solution for those who want 80mm and longer stubble. Depending on how you bolt the skids to the cutterbar, you can increase the cutting height by 30 mm or 50 mm, which is ideal in forage and whole crop silage.



Added protection

We welded curved stops between the individual skids that protect the cutterbar from damage and also contoured the underside of the stops in such a way that no material can build up here and instead flows smoothly to the rear.





Minimised wear

The blades are free to spin 360° on their pins. They are hard-wearing and self-cleaning, well protected and will not foul with the blades on the neighbouring discs.



Clean cuts

Blades of 112 mm length orbit with a generous overlap, producing the typically clean cuts and feeding the material to the rear in a consistent flow.

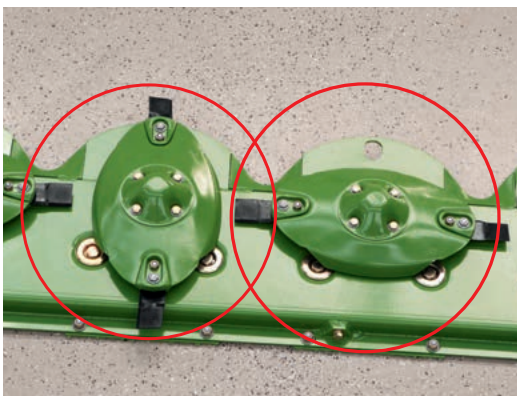

Cost saver

Worn blade fixing pins and wear parts are not an issue for KRONE Easy-Cut, because the modular design of the discs allows you to replace them individually. If you like, you can opt for bolts instead of pins.



The KRONE SafeCut system

- Full driveline protection for added reliability
- Neighbouring discs will not collide
- Wear-free
- Quick-change roll pins for minimum downtime and costs

Colliding discs may cause damage and involve costly repairs. KRONE SafeCut offers a maximum of protection and peace of mind. The award winning system on all EasyCut models offers a unique level of protection and operator comfort. SafeCut is a base specification feature on all EasyCut F and R models.



Two-fold protection

Orbiting within the sphere of the mower bed and never protruding beyond the skids, the EasyCut discs benefit from two-fold protection. Additional protection comes from the standard SafeCut system.

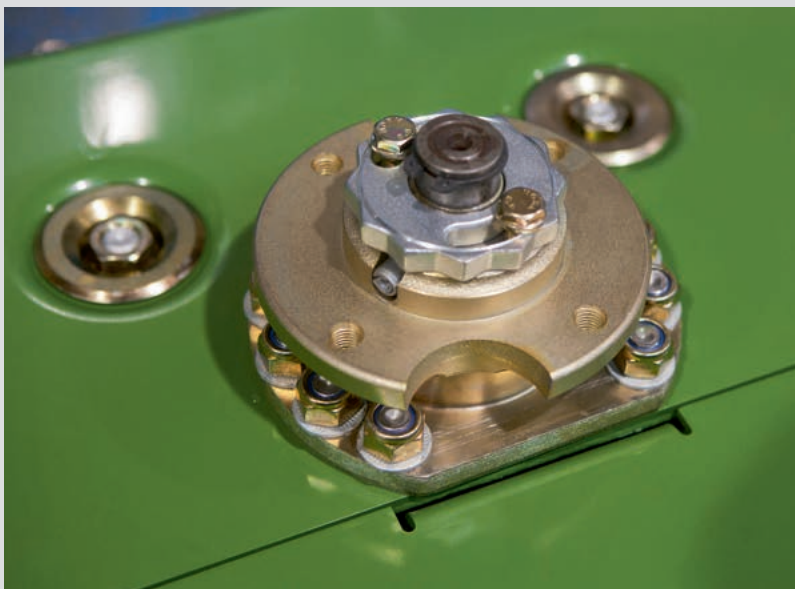

An ideal system

There is no load on the roll pins during operation. The bearing is tensioned by a nut and two clamping screws. As a result, the roll pins do not suffer from material fatigue and even after many hours of operation they will break only at their inbuilt load level.



Simply ingenious

Each disc on the mower has its own individual impact protection. When the blade hits an obstacle the shockload is transferred to a roll pin which breaks. As a result, the disc automatically threads 15 mm up on the drive shaft.

Effective and safe

If the system is suddenly overloaded, the impact is not directed to the spur gears in the driveline, instead a roll pin in the sprocket drive shaft shears off. The pinion shaft continues spinning, jacking up the disc in question, moving it out of the

risk zone and the orbit of the neighbouring discs. As a result, SafeCut prevents damage to the spur gears and the neighbouring discs. Replacing the roll pin takes a few minutes and is not very costly.

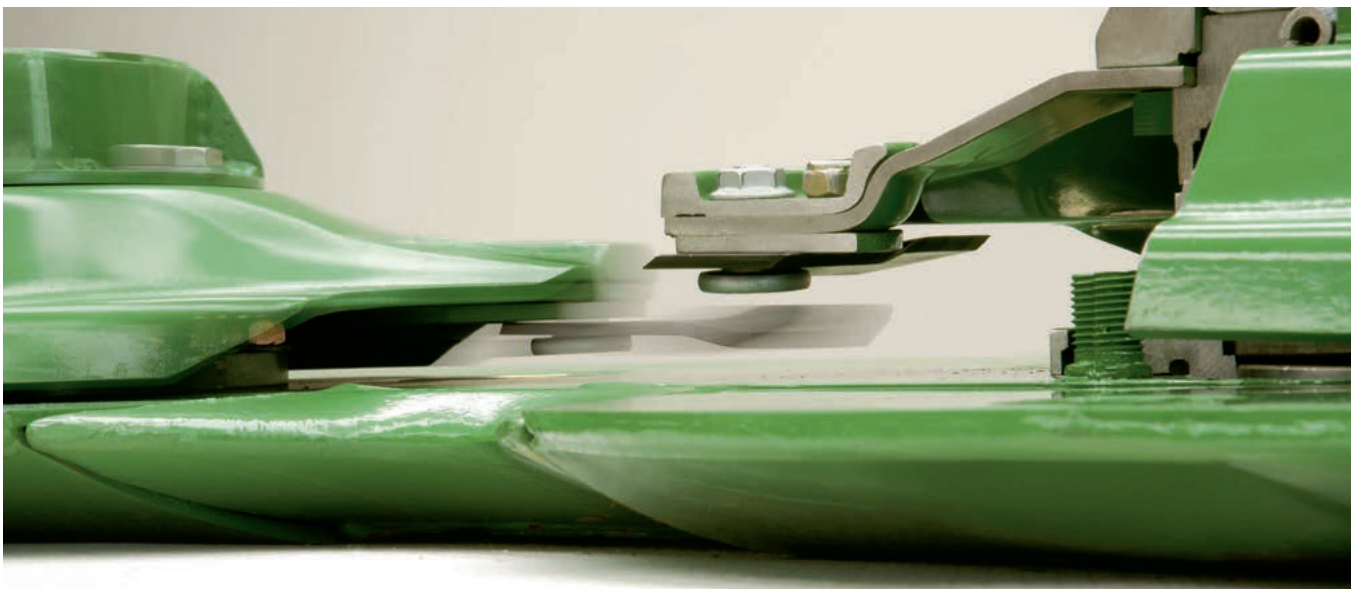



The KRONE DuoGrip centre-of-gravity suspension

- Patented DuoGrip attachment: Mounted in the centre of gravity and controlled by parallel arms
- Uniform ground pressure across the entire work width
- Excellent guidance: less side thrust, clean cuts
- Continuous suspension for superb contouring and sward protection

The KRONE DuoGrip suspends the mower in its centre of gravity and guides it via two arms. This design allows the cutterbar to follow the ground contours even more accurately for a better protection of the sward. and high-quality forage even in difficult conditions.



Spreading the load

The parallelogram linkage absorbs lateral forces and guides the unit in direction of travel. At the same time, it helps reduce the load on the jib and the suspension system in the machine's centre of gravity.



Strong

The mower is mounted on a pin which pivots in a ball bearing at the end of the outrigger arm. This design provides plenty of movement and exemplary contouring. In addition, the headstock features a standard and integral break-back system for effective impact protection.



Accurate setup

For optimum mower control, position the tractor's lower links in such a way that the two control arms on the mowers are level. The red arrow indicates the correct height of the lower links.

Suspended in its centre of gravity

Maintaining a uniform pressure across the entire work width is a requirement that is thoroughly met by KRONE disc mowers, courtesy of the gearbox that is arranged on the inside of the machine where it shifts the centre of gravity to the side. This, the short arm and two extra braces give maximum stability while keeping the weight down – and delivering best results in rough going.





The KRONE CV tine conditioner

- V-shaped steel tines at steep angles give intensive and perfect conditioning
- The driveline dispenses with belts for frictional and low-maintenance connections
- Great operator comfort from mechanical conditioner gearbox
- Adjustable baffle plates for enhanced conditioning

Efficiency is one parameter in hay and forage harvesting, quality is another. The high-performance KRONE CV conditioner with V-shaped steel tines spreads the crop at the full working width. The 640 mm diameter rotor and the helical arrangement of the tines warrant a continuous crop flow, high throughputs and superior conditioning.



Firm grip on the crop

The v-tines are made from hardened steel and mount at a steep angle, treating the forage intensively and powerfully. The tines pivot to the rear when hitting a foreign object whereas their restricted forward angle increases the pivot pin's lifetime.



Full-width application

The V-shaped steel tines on each mower span across the entire work width and from the left to the right drum, providing a uniform crop flow across the full width and optimum conditioning. Guide plates are available for wide spreading and even faster conditioning.

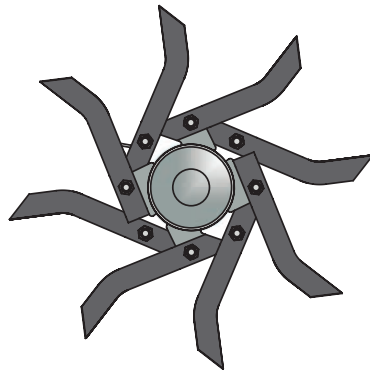

It's intensive

The CV conditioners that are used on the EasyCut B 870 CV and B 1000 CV mowers have adjustable baffle plates as standard specification. These support the tines and increase the degree of conditioning.

Stepless baffle plate adjustment

The tine-plate clearance is adjusted from a 7-notch system and presents another option to alter the degree of treatment. As you reduce the gap you increase the intensity of conditioning.

The mechanical gearbox

Select 900rpm for intensive treatment and 600rpm for less intensive conditioning, which is easy on the mechanical gearbox.

Flexible spreading widths

The optional deflectors adjust to one of two spreading positions. You either form the material into narrow swaths on wet and boggy terrain or spread it across the work width for faster wilting.





The KRONE CR roller conditioners

The roller conditioner models (polyurethane rollers or M-Rolls)

- Consistent crop flow by 25 cm diameter rollers
- High throughput from powered crop processor rollers
- Top quality from profiled rollers – thanks to their ‘meshing effect’
- Choice of roller conditioners – polyurethane rollers or steel M-Rolls

Leafy crops like Lucerne or clovers require a different type of conditioning than crops that are predominantly grass. The CR roller conditioners give particularly gentle treatment, leaving the delicate leaves intact which are so rich in protein and safeguarding the value of the feed. Spreading the crop will speed up wilting.

Spring suspension

The top roller suspends from a spring which ensures a continuous flow in inconsistent growth and allows foreign objects to pass the system trouble-free. Thanks to a stepless adjustment system, the operator adapts the gap and pressure steplessly to current yields.



Frictional connections

The conditioning rollers are driven by gearboxes. The box that drives the bottom roller is integrated in the gearbox that powers the cutterbar.

Full-width application

The full-width CR rollers ensure a uniform conditioning effect across the entire work width. And the rubber coating ensures maximum longevity. The interlocking surfaces of the rollers give intensive but gentle conditioning whilst avoiding losses.



250 mm diameter

The large-diameter CR conditioner rotors deliver a smooth and consistent flow of crop and have a low power input.

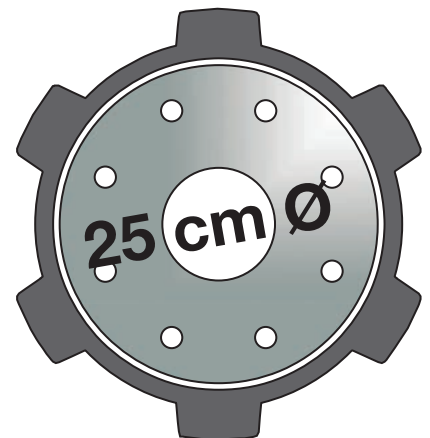



Two drives for double power

The top roll of the M-Rolls is driven by a separate gearbox on the right end of the cutter-bar which synchronizes the speed of the top and bottom rolls, bracing you for wet and heavy crops.



Perfect treatment from profiled M-Rolls

The counter-rotating M-Rolls mesh to crush the material and yet leave a sufficiently wide gap for the material to pass through. The result is a uniform conditioning quality for uniform wilting and no fragmentation – the perfect system for lucerne, for example.

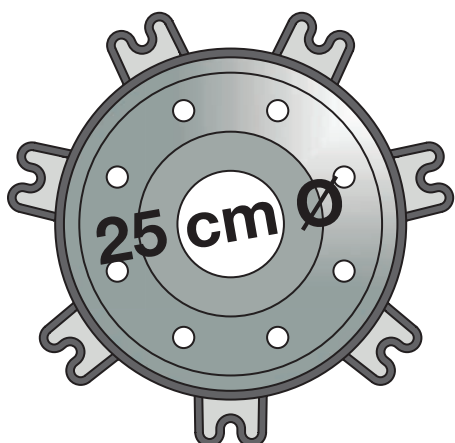



The KRONE **Collect** system

Mower conditioners merge the crop flow from two machines into one central swath

- Variable swath widths are provided by steplessly adjustable accelerator rollers
- On-board hydraulic system
- The merger belts can be raised separately
- Moulded deflector plates ensure a loss-free transfer of the crop
- Extra wide 910 mm cross belts handle large volumes of crop

The KRONE Collect system offers multiple setting options that suit the most diverse applications around the world. The Collect merger belts deliver clean and perfect swaths that are easily picked up by the following harvester for loss-free harvests.



Nothing gets lost

The conditioners on EasyCut B 870 CV Collect and B 1000 CV Collect have curved deflector plates that guide all the material to the merger belts – nothing gets lost.

Manual swath width control

EasyCut B 870 CV Collect and B 870 CR Collect operators adjust the swath width manually by altering the belt speed. The height of the optional accelerator rollers is also altered manually. No tools required.



Electric swath width adjustment

Operators of ISOBUS-compatible EasyCut B 1000 CV Collect and B 1000 CR Collect mowers adjust the swath width electrically by altering the belt speed and the height of the optional accelerator rollers. The option of electric motors offers great operator comfort.





On-board hydraulic system

The merger belts are driven by an on-board hydraulic system which is cooled by a separate oil cooler.



Adjustable swathing boards

Adjustable swathing boards optimize the crop flow and the crop feed to the belts.



Separate lift-out

Powerful hydraulic rams raise the merger belts reliably – either in synch or independently.



EasyCut B 870 · B 1000

Butterfly combinations without conditioners

- Variable, up to 10.00 m work widths on EasyCut B 1000
- Weight-optimized headstock reduces rear axle weight and ground pressure.
- Adjustable non-stop break-back system is a standard feature
- SmartCut and SafeCut ensure perfect cuts and maximum uptime
- Hydraulic suspension is as a standard feature

The EasyCut B 870 and B 1000 are two high-capacity mower combinations. They feature leading edge technology and a new styling plus a weight-optimised headstock with hydraulic suspension that helps protect the sward and also attaches to smaller tractors.

Close to the tractor

The weight-optimised headstock is coupled in the three-point linkage with three-fold buttressed pins, a design that moves the centre of gravity closer to the tractor, enabling the use of smaller tractors.



Optimum protection

The headstock is protected by a new cover. The befitting curtains on the mower decks are thin and taut, reducing the build-up of material and protecting the cutterbar from damage by stones.





Adjustable break-back system

The mower combinations have a standard non-stop break-back system that offers an infinitely variable trip force set on a coil spring. When the machine hits an obstacle the system trips immediately and the mower swings up to 1.60 m rear and upwards. Once the obstacle has been passed the cutterbar moves automatically back into work position.



Ideal powerflow

The mower combination is powered by a 1,000 rpm pto. The main gearbox in the middle splits the powerflow and sends it to the downstream pto shafts. The driveline is protected by break-back systems and overrunning clutches.



EasyCut B 870 · B 1000

Easy and convenient setup

- The mower arms adjust to one two positions (EasyCut B 870) or infinitely variably (EasyCut B 1000) to provide optimum overlapping
- Optimum overlapping eliminates striping in curves and on slopes
- Hydraulic ground pressure control conveniently from the cab

EasyCut B 870 and B 1000 are no-compromise machines.

The infinitely variable arm length control adapts overlaps to the current conditions without compromising on acreage and output.



EasyCut B 870: Two overlap positions

EasyCut B 870 offers two attachment positions for the mower arms which allow operators to set the distance between the two mowers to 1.99 m, which is helpful in sloping fields and curved passes. In combinations with a 3.16 m front mower, this setup leads to 59 cm overlaps and a total work width of 8.31 m. In flat fields and straight passes, however, you can extend the mower-to-mower distance to 2.30 m, which reduces the overlap to 43 cm and increases the total work width to 8.62 m thereby maximising productivity.



EasyCut B 1000: Setting overlaps infinitely variably

EasyCut B 1000 operators set front-rear overlaps on the move and infinitely variably on the cab-based terminal. At the same time, they can vary the distance between the other rear mowers between 2.08 m and 2.80 m. When combining this model with a 3.16 m front mower, the overlap on both sides ranges from 18 cm to 59 cm. This allows operators to adapt the combination flexibly to current conditions and maintain high work rates and a clean cut.



Perfect in corners

The independent machine lift-out feature, a standard specification, makes it easy to cut awkward corners. Simply select the specific mower on the control box and then raise it hydraulically.



Hydraulic suspension

The DuoGrip centre of gravity suspension allows all mowers in the combination to maintain a consistent ground pressure across the entire working width. You simply set the pressure hydraulically from the cab. It is then indicated on the pressure gauge. The system delivers optimum contouring and perfect cuts.



EasyCut B 870 · B 1000

Easy use

- Safe road travel thanks to 95° transport angle. Less than 4 m transport height and 3 m width.
- Compact storage position on sturdy stands
- LED lights and reflecting warning panels are standard specification

The carefully designed folding mechanism makes for a compact storage position. Road travel is safe, too thanks to the compact transport dimensions.



Compact combination

Measuring only less than 4m high and less than 3m wide, these mower combinations absorb very little storage space. They are parked on sturdy stands.

Extra stability on the EasyCut B 1000 comes from an outrigger on the cutterbar and hoop guards (option on EasyCut B 870).



Automatically locked for transport

Hydraulic check valves lock and release the mowers automatically when these are moved into work or transport position.



Safe travel

The mowers fold into a 95° transport position, slightly leaning to the middle. The end curtains drop automatically into transport position as the units fold into the vertical.



Supply of spare blades

These removable drawers are standard specification on the mower combination. Here you store your spare blades to have them readily at hand. The blades are quick-change as standard.



Easy operation

You can select various machine functions from the control box. These are then executed by the tractor's hydraulic system. This technology requires only a single-acting and a double-acting spool.



LED lights on board

LED lights at the rear and a brake light with an integral red-white reflector panel provide adequate road safety.



EasyCut B 750 · B 890 · B 970

Tractor attachment and drives

- Huge work widths of up to 9.70 m
- The telescoping arms on EasyCut B 890 and B 970 ensure perfect overlapping
- The compact headstock with break-back protection gives maximum operator comfort
- A compensating rocker distributes the weight and ground uniformly to both wings

The robust combination combines state-of-the-art mower technology and offers working widths of 7.46 m to 9.70 m for productivity. The mowers not only offer light pulling and high acreages but also superior functionality and perfect cuts.

Standard impact damage protection

Safety and operational reliability is another important area of excellence. For example, EasyCut 750 pivots through a 1.20 m arc, the EasyCut B 890 through 1.40 m and the EasyCut B 970 through 1.60 m. Once the system triggers, the complete mower swings back and up and away from the obstacle. After the obstacle is passed, the unit returns automatically into its working position.



Optimum protection

These mowers use a coil spring to set the tripping force of the impact protection system, which trips instantly when the unit meets an obstacle.

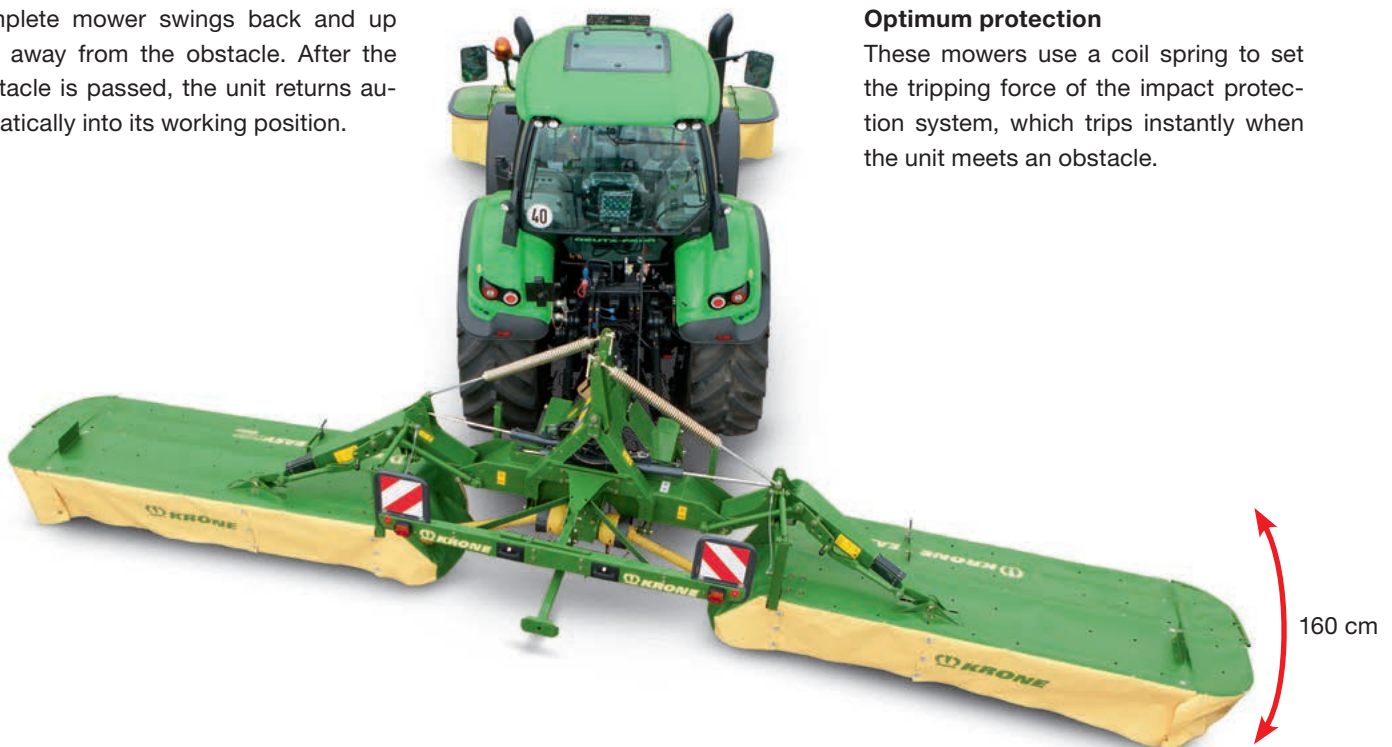

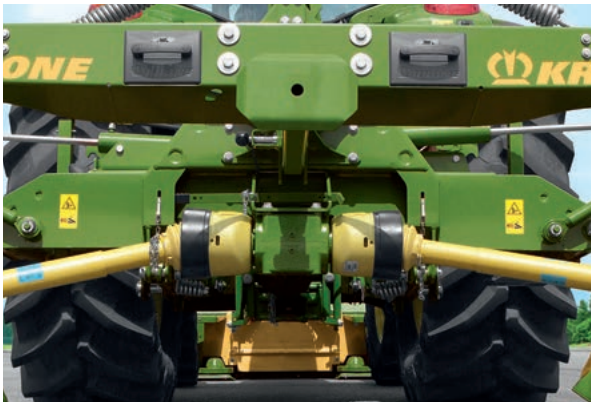

The central gearbox

Mounted centrally on the rear unit, the main gearbox sends the tractor power down the straight drivelines, which feature integral overload protection, clutches and overrunning clutches to protect the mower and tractor. The box requires a 1,000 rpm pto.

DuoGrip centre-of-gravity suspension

The robust headstock offers a compact and uncluttered design. The decks do not suspend centrally but in their centre of gravity and receive extra guidance from lateral arms. The DuoGrip centre-of-gravity suspension maintains a uniform ground pressure across the entire work width and gives easy pulling, great ground contouring and a large pivot range.



Maintaining a uniform ground pressure

The suspension arms ensure both wings operate at identical pressures in undulating terrain, which is evidenced by the uniform cut. The spring pressure is set on a turnbuckle.



EasyCut B 750 · B 890 · B 970

Adjustable overlaps

- EasyCut B 890 and B 970 offer overlap adjustment without tools
- Generous overlaps and clean cuts in bends and on slopes
- No fiddling with transport height

EasyCut B 890 and EasyCut B 970 operators can change the distance between the two side mowers for stripeless cuts on slopes and in bends. The standard telescoping arms adjust the wings to overlap up to 45 cm with the 3.16 m KRONE front mower. The feature ensures clean and loss-free cuts utilizing the machine at its full span in large and flat fields.



As easy as it gets

The overlap is set on a pin on each mower arm. The setting does not affect the unit's transport height.

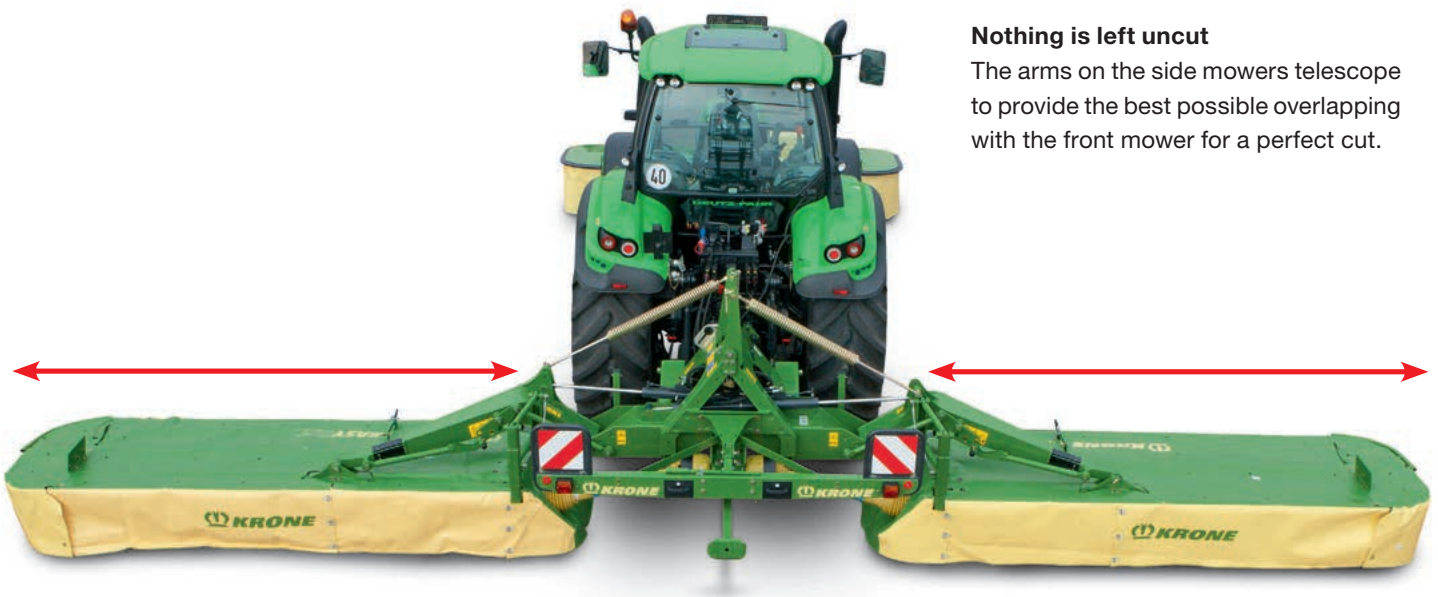

Nothing is left uncut

The arms on the side mowers telescope to provide the best possible overlapping with the front mower for a perfect cut.



Telescoping

The 3.16 m EasyCut B 890 and B 970 front mower offers three different settings to implement the following overlaps:

- Position I: 30.00 cm overlap
- Position II: 38.00 cm overlap
- Position III: 45.00 cm overlap





EasyCut B 750 · B 890 · B 970

Easy handling

- Control box for maximum comfort
- Operate the side mowers in synch or individually
- Compact on the road: Not exceeding the 4.00 m transport height and 2.95 m width limitations plus offering a 25 cm ground clearance

The KRONE mower combinations offer professional farmers and contractors the specification and comfort they need: a large work width, an enormous efficiency and compact build, as well as low tractor input, ease of operation and excellent handling – all being true benchmark features for a mower in this class.



For all tractor back ends

Raise both mowers simultaneously as you approach the headland or one mower individually when finishing up wedges or awkward areas.



Minimum space

Folded into transport position and safely propped by sturdy stands, the 2.95 m wide EasyCut B 750, B 890 and B 970 models require about 3.70 m to 4.00 m in height. In transport, these machines won't exceed the maximum height of 4 m and yet give a generous 25 cm ground clearance.



Effective and safe

These latches secure the EasyCut B 750 wings in transport position. This system gives peace of mind when travelling at speed between fields.

Convenient for operators

EasyCut B 890 and EasyCut B 970 have hydraulic chests that secure each mower in its transport position and ensure automatic locking and unlocking for lifting and lowering.

Strong double rams lift out the machines

Short-length and single-acting rams move the mowers to headland position whereas the longer double-acting rams make for controlled lifting and lowering on slopes.





EasyCut B 950 Collect

The mower combination without conditioner but with merger augers

- Light-weight and compact mowers without conditioners
- 9.45m working width including front mower
- Massive augers merge the swaths
- Three swathing modes are selected from the cab: central swathing, independent swathing and no swathing
- Hydraulic mower suspension controlled from the cab

The EasyCut B 950 Collect is a very compact combination that has merger augers but no conditioners. The massive augers merge large volumes of crop such as green rye into a uniform and clean swath.



Three swathing modes

The decks behind the augers open and close hydraulically for convenient selection of one of the three swathing modes from the cab: swathing, independent swathing or no swathing.



Powerful merger augers

The sturdy 45 cm diameter cross augers are powered by a right-angle gearbox and revolve at a consistent speed of 750rpm, giving maximum efficiency and productivity. Arranged closely behind the cutterbars, these augers feed large volumes of crop in a consistent flow from the mowers to the middle of the combination, forming a tidy and uniform swath that is cleanly gathered by the following harvesters.



The three-point hitch

The DuoGrip system suspends each unit in its centre of gravity and provides extra guidance by lateral arms for superior ground contour hugging. The rear lights can be raised hydraulically as an option to clear the way for more material to pass through this area. Lowered into transport position, they increase road safety.



The mowers lift out separately as a standard feature

Operators can raise one mower when cutting wedges. Simply select the mower that is not in work on the electric control box and raise it.



Variable cutting heights

The standard combi skids increase the cutting height from 50 mm to 120 mm and allow operators to cut different crops like grass and green rye at different heights.



EasyCut B 950 Collect



The hydraulic suspension

The EasyCut B 950 Collect mowers feature hydraulic suspension which allows operators to adjust contouring from the electric control box in the cab. The level of response is set steplessly and the current setting is indicated on a pressure gauge that is easily read from the cab – for best contouring even in very difficult conditions.



Hydraulic crop deflector

A hydraulic crop deflector is available for those who seek even more uniform swaths. When the B 950 Collect moves from road position to headland position the crop deflector is sequence controlled into its horizontal working position. This option is particularly useful in wedge-shaped plots or when one mower is not swathing.



One mower is not swathing

To minimize losses when working along field borders, operators can switch between spreading and swathing – separately by mower, on the move and from the convenience of the cab. This will not change the mowers' working position. Having one mower swath the crop is useful when opening a field and when cutting around obstacles. This option is also very useful in later cuts and in combination with a KRONE four-rotor rake.



Transport position

For safe road transport, the curtains on the sides fold up automatically. The transport height is less than 4 m.



Operation

The EasyCut B 950 Collect is operated from this cab-based and straightforward control unit which is a standard feature.







EasyCut **B 870 CV** · **B 870 CR**

The mower combinations with conditioners

- 8.70 m work width
- EasyCut B 870 CV with tine conditioner
- EasyCut B 870 CR with roller conditioner (rubber rollers or M-Rolls)
- A balancing arm ensures the ground pressure is uniform on either side
- A standard break-back system gives effective protection

EasyCut B 870 CV and CR utilize the tractor to the full and save time and costs. The versatile model is the EasyCut B 870. Featuring conditioners and extra wide merger belts, this machine enables you to cut, condition and spread or swath the material in one single pass.

Convenient for operators

Holders on the machine store the oil hoses when the machine is removed from the tractor. The hose couplers have numbered handles for easier attachment and removal.



A KRONE exclusive!

The patented compensating rocker on the adjustable spring suspension system distributes the ground pressure evenly to both mowers. This feature guarantees cleanest cuts and forage, light pulling and protection of the valuable sward.





Simple driveline

The driveline is simple and efficient. A main gearbox on the headstock splits the power and sends it to the side mowers.

Double-acting rams

Double-acting rams provide dependable control of each unit as it lifts and lowers on slopes whereas single-acting rams lift them into headland position.

Limiting the pivot range

Hydraulic rams limit the transverse travel of the mowers that suspend in their centre of gravity, giving plenty of ground clearance during the headland turn or travel on public roads.





EasyCut **B 1000 CV** · **B 1000 CR**

Featuring conditioners and KRONE Combi Float suspension control

- High work rates from up to 10.10 m working widths
- EasyCut B 1000 CV with steel tine conditioner
- EasyCut B 1000 CR with an aggressive roller conditioner
- Hydro-pneumatic compensation for uniform ground pressures
- A standard break-back system gives effective protection

The EasyCut B 1000 CV and EasyCut B 1000 CR stand out for a huge 10.10 m work width and their powerful CV or CR conditioners. Another high-profile feature is the world-first Combi Float – the automatic and hydro-pneumatic control system.

Fully protected

The standard impact damage protection system on EasyCut B 1000 CV and B 1000 CR gives you peace of mind as you cut along borders, fences and hedges and when the machine hits an obstacle. When one of the side mowers hits an obstacle it swings approx. 1.50 m to the rear and returns automatically into its working position once the obstacle is passed.



Adjustable and flexible

The responsive break-back system moves the machine reliably up and to the rear. It's tripping force is set steplessly on the coil springs.

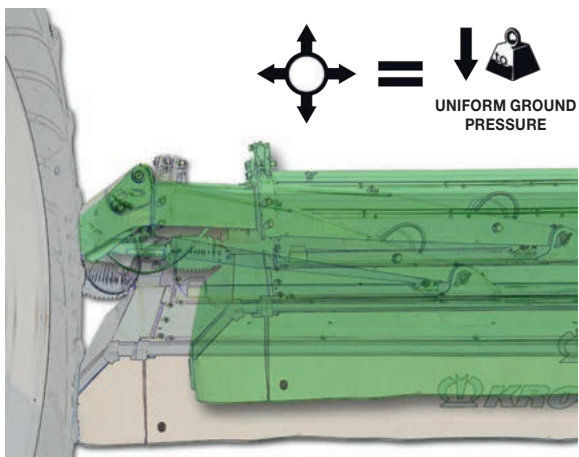

The automatic Combi Float suspension control offers unique advantages:

- It maintains a uniform ground pressure in undulating terrain and with the mowers working in offset positions.
- The mower suspension is easily adjusted from the tractor seat – even on the move.
- A lightweight, hardwearing, easy-pulling and compact design.



An integral system

The compact headstock integrates the lift rams, the valve chest and the accumulators for reduced weight and load on the tractor's hydraulics. It also features an easy-to-open cover for effective protection.



Combi Float – a KRONE only

The speciality of this feature is the fact that it maintains the pressure inside the reservoirs of the hydro-pneumatic system – courtesy of extra spools and the circuit of the single-acting coupler with free return line. The advantage of this system is that it maintains a uniform suspension of both mowers in undulating terrain and when working at various work widths.



EasyCut B 1000 CV · B 1000 CR

Accurate overlaps

- Hydraulic overlap adjustment
- Large setting range of up to 40cm per side
- Cleanest cuts in bends and on slopes

The hydraulic sideshift feature on the side mowers eliminates any striping and maximizes efficiency productivity. The feature is standard specification. Cutting straight lines, the machine operates at the maximum width and minimum overlap, whereas larger overlaps and a narrow work width is selected when cutting curved lines. As you operate on the slope, simply retrieve a stored sideshift range to the right or left and avoid drifting and striping.

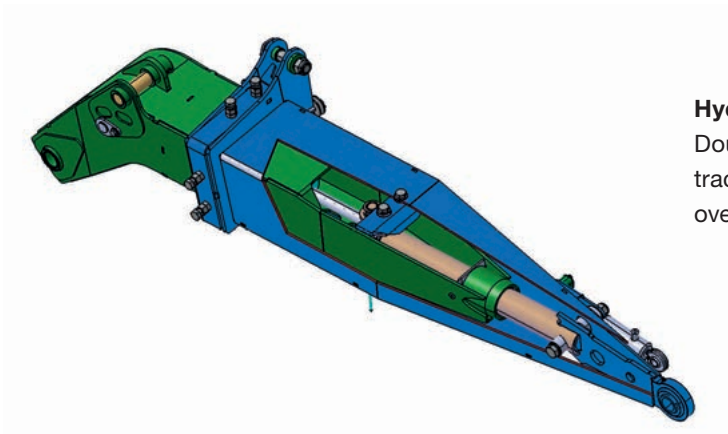

Hydraulic control

Double-acting rams inside the mower arms extend and retract the arms on the move thereby varying the degree of overlap.

Optimum adaptation

The mower arms on the EasyCut B 1000 CV and B 1000 CR side mowers extend and retract on telescoping arms. As you shift the two mowers in opposed directions you alter the overlap relative to the front mower and the total work width.

When using an EasyCut front mower of a 3.16 m work width, you can set overlaps from 130 to 530 mm on each wing. To avoid striping on slopes, shift the wings to the same side.





Flexible control

The ISOBUS terminal allows operators to telescope the rear mowers hydraulically in and out, either in sync. or independently by up to 40 cm. In addition, the standard-fit terminal adjusts the work width simultaneously on both sides.

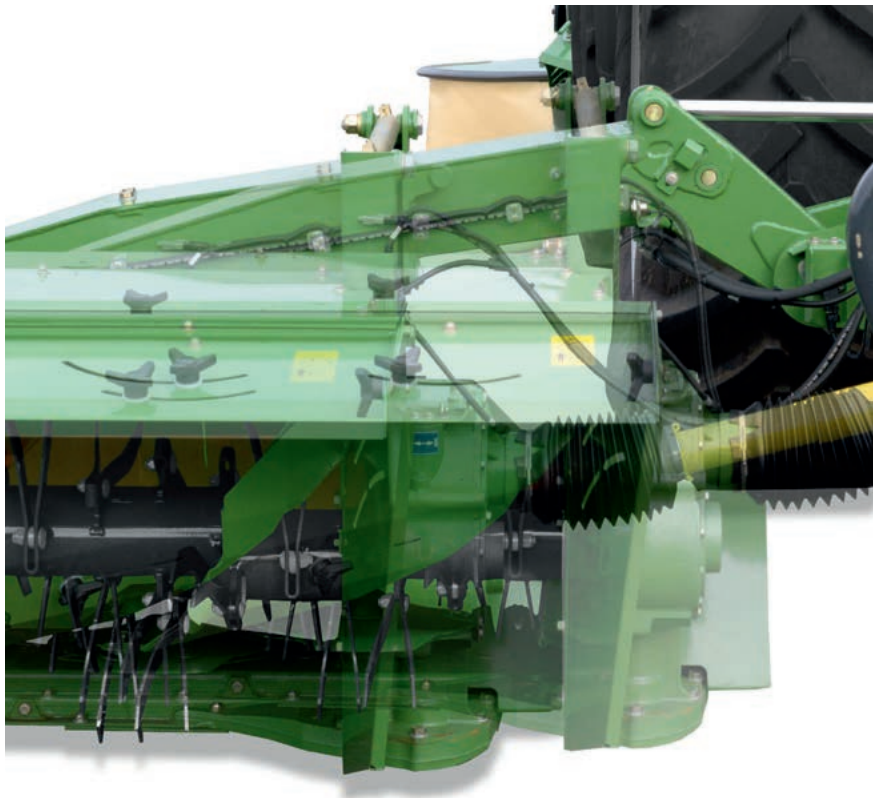



EasyCut B 1000 CV · B 1000 CR

Excellent handling in all situations

- Convenient headland function by fingertip control
- Safe road travel:
4.00 m transport height and less than 3 m transport width
- Great operator comfort:
Compact on the tractor, adjustable tractor-machine distance
- Minimum space requirement by storing in transport position

As they fold into transport position the side mowers retract automatically so the statutory 4.00 m transport height is not exceeded. An automatic transport locking system provides for safe road travel and is activated as the rear mowers are shifted to the middle.



For all tractor back ends

All three mowers lift and lower at the touch of a button when the tractor approaches the headland. You can operate the front linkage from the valve chest on the rear combination. Cutting wedges or awkward plots is easy as you use one or two mowers. The machine is not running on cut material. EasyCut B 1000 CV not only delivers an exceptional performance in large fields but also in smaller plots, producing clean cuts and perfectly conditioned forage.

Compact storage

Store the side mowers on their sturdy stands in upright position and save space for more equipment in your shed.



Automatic

For a reduced transport height the end guards on each mower fold up automatically as the machine folds up.

Innovative

The wings are raised by compact double rams, which reduces operator stress. The single-acting rams lift the mowers into headland position; the double-acting rams fold them into transport position.





EasyCut B 870/1000 CV and CR Collect

The mower combinations with optional conditioners and merger augers

- Extra wide merger belts ensure a continuous flow even in high volumes of crop
- Each belts can be raised individually, providing one of the three swathing modes available: central swathing, independent swathing or no swathing
- Belts shut off and on automatically when raised and lowered

The Collect system with merger belts makes EasyCut B 870 CV and B 1000 CV with steel tine conditioners and EasyCut B 870 CR and B 1000 CR with roller conditioners versatile machines that spread the material across the working width or produce one central or two individual swaths. The powerful belts handle even the heaviest crops most effectively.



Pumping out masses of material

Cutting whole crop silage requires powerful machines with plenty of clearance. The Collect mower combinations have nearly 1 m wide merger belts that merge even the highest volumes of crop to the middle. Depending on the crop growth and the desired shape of the swath, operators can adjust belt speeds hydraulically from the tractor seat.



Central swathing

The Collect System groups three passes into one – cutting, conditioning and swathing, thereby reducing the number of passes and the risk of compaction and damage to the turf and of course crop contamination.



1. No swathing

Raise the belts and spread the material across the full width. Spreading the material speeds up wilting and helps achieve target DM rates faster.

2. Clearing the boundaries

Operate only one belt to clear a pass along the border for hassle-free work for the following harvester.

3. One mower is not swathing

In one up-and-down operation, EasyCut B 1000 CV groups up to 20.20 m of work into four swaths and 13.00 m – ideal for further swathing by a KRONE four-rotor centre delivery rake.

4. Boosting your efficiency

Using only one merger belt and reducing the spreading width saves costs and time and reduces compaction if followed by a KRONE four-rotor centre-delivery rake.





Operation



Tailored to your tractor



■ Convenient for operators



■ Clear concept



■ Easy

The B 1000 CV/CR (Collect) gives you the choice of operating it from a simple electric pre-select box that is also used on the other EasyCut Butterfly models or from an ISOBUS-compatible device. The ISOBUS-compatible devices comprise a large choice of terminals and intuitive-use control units. SectionControl, the new CCI 1200/800 and the tried and tested Aux joystick WTK are just two examples of what's available.

SectionControl

The EasyCut B 1000 CV/CR Collect mowers are also available with SectionControl. This feature switches the individual sections from headland to working position and vice versa – automatically and with the optimum timing, reducing operator strain and maximizing productivity.



Easy operation

The user-friendly control units on EasyCut B 750, B 870, B 890, B 970 und B 1000 allow operators to select transport position, headland and work position by flicking the rocker switches and control each mower separately.



Dialling in

A dial on the EasyCut B 870 CV Collect control box sets the belt speed infinitely variably. The belt stops moving the moment it is raised out of work.



Straightforward

The standard control unit on EasyCut B 950 Collect, B 1000 CR/CV and CV Collect allows operators to adjust the mower suspension from a dial and to preselect a function, which is then executed by a remote spool.



ISOBUS CCI 800 terminal

With an 8" colour touchscreen, the CCI 800 ISOBUS terminal offers maximum user comfort. The screen displays one function at maximum zoom level and two further functions in a mini viewer, giving you full control of all features. In addition, it combines with AUX joysticks, cameras and SectionControl licence.

ISOBUS CCI 1200 terminal

As an option, EasyCut B 1000 is available with the ISOBUS-terminal CCI 1200 which offers a 12" display screen that allows operators to simultaneously view the machine interface, the camera feed, the functions of the individual joystick controls and the SectionControl status.



ISOBUS tractor terminal

Thanks to its ISOBUS certification, the B 1000 can be operated from various tractor terminals. No further devices are necessary to operate the machine – for maximum operator comfort.



AUX joystick WTK

The AUX joystick WTK offers optimized ergonomics. Three menu levels are navigated from eight buttons, offering as many as 24 customizable functions. Providing haptic feedback, this control unit allows operators to use it without looking at it. Also, thanks to its ergonomic design, the unit falls easily to hand for fatigue-free use on long working days.



Perfect overlapping

This is the EasyCut front mower to form the KRONE triple combination

For high work rates and stripeless cuts on flat land and in curves and on slopes it takes a combination of mowers that work at just the right overlap, as small as possible and as wide as necessary. Matching the right EasyCut front mower with the right EasyCut B side mowers is of paramount importance here.



	F 280 M	F 280	F 320 M	
B 750	37 cm	36 cm	58 cm	
B 890	9 cm - 17 cm - 25 cm	8 cm - 16 cm - 25 cm	30 cm - 38 cm - 45 cm	
B 970	9 cm - 17 cm - 25 cm	8 cm - 16 cm - 25 cm	30 cm - 38 cm - 45 cm	
B 870	21 cm / 37 cm	20 cm / 36 cm	45 cm / 59 cm	
B 1000	0 cm - 33 cm stepless	0 cm - 32 cm stepless	18 cm - 54 cm stepless	
B 950 Collect	24 cm	23 cm	46 cm	
B 870 CV (Collect)				
B 870 CR (Collect)				
B 1000 CV (Collect)				
B 1000 CR (Collect)				



	F 320	F 320 CV / F 320 CR	F 360 M	F 360 CV / F 360 CR	F 400 CV Fold
	57 cm		80 cm		
	29 cm - 37 cm - 44 cm		52 cm - 60 cm - 67 cm		
	29 cm - 37 cm - 44 cm		52 cm - 60 cm - 67 cm		
	44 cm / 58 cm		65 cm / 81 cm		
	17 cm - 53 cm stepless		40 - 76 cm stepless		
	44 cm	46 cm	67 cm	67 cm	89 cm
		40 cm		62 cm	84 cm
		40 cm		62 cm	84 cm
		13 cm - 53 cm stepless		35 cm - 75 cm stepless	57 cm - 97 cm stepless
		13 cm - 53 cm stepless		35 cm - 75 cm stepless	57 cm - 97 cm stepless



Protecting wildlife

in the breeding and nesting season



There are many different approaches to protect local wildlife and reap a high-quality forage feed. The Hubertus audible alarm device is certainly a good initial step in scaring off animals but it can never replace the communication between farmers, contractors and hunters, because visual inspections of the fields are indispensable. Applying the proper mowing strategy is also of key importance.

Join in and let's take preventive measures!

My 'First Cut' check list

- Hunters informed on the cutting date ✓
- Field inspected for fawns and nests ✓
- Hubertus Wildlife warning system used ✓ 
- Proper mowing strategy in place ✓ (inside out)

Mowing strategy

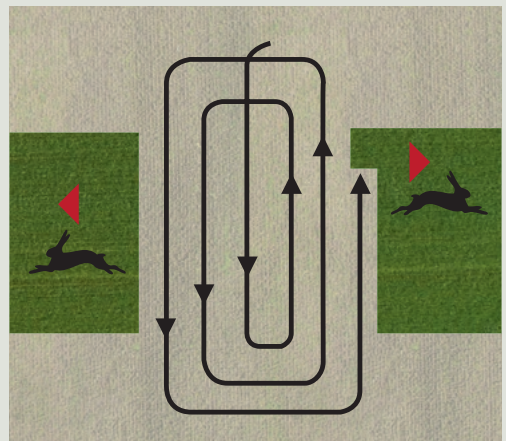



Technical data

- Total work widths from 7.46 m to 10.10 m
- Area output: 7 ha/h to 14 ha/h
- SafeCut and quick-change blades are standard features
- **Collect** models with merger belts or augers

		EasyCut B 750	EasyCut B 870	EasyCut B 890	EasyCut B 970	EasyCut B 1000	EasyCut B 950 Collect
Work width	Approx. m	7.46 (24'6")	8.31/8.62 (27'3"/28'3")	8.60-8.90 (28'3"-29'2")	9.40-9.70 (30'10" - 31'10")	9.28-10.00 (30'5"-32'10")	9.45 (11'4")
Work width / rear-mounted mower	Approx. m	2.73 (8'12")	3.16 (10'4")	3.16 (10'4")	3.60 (11'10")	3.60 (11'10")	3.60 (11'10")
Total transport width	Approx. m	2.87 (9'5")	2.99 (9'10")	2.99 (9'10")	2.99 (9'10")	2.99 (9'10")	3.00 (9'10")
Storage height	Approx. m	3.45 (11'4")	3.40 (11'11")	3.70 (12'2")	4.00 (13'2")	4.00 (13'2")	4.00 (13'2")
Transport height at 250/200 mm ground clearance	Approx. m	3.35 (11')	3.60 (11'10")	3.60 (11'10")	4.00 (13'2")	4.00 (13'2")	4.00 (13'2")
No. of discs*		8	10	10	12 (8)	12	12
No. of top hats*		4	4	4	4 (8)	4	4
Quick-change blades		Standard	Standard	Standard	Standard	Standard	Standard
SafeCut		Standard	Standard	Standard	Standard	Standard	Standard
Conditioner		–	–	–	–	–	–
Rotor diameter	Approx. cm	–	–	–	–	–	–
Conditioner speed	rpm	–	–	–	–	–	–
Merger augers		–	–	–	–	–	Standard
Merger belts		–	–	–	–	–	–
PTO speed	rpm	1,000	1,000	1,000	1,000	1,000	1,000
Hydraulic couplers		2 sa	1 sa, 1 da	1 sa, 1 da	1 sa, 1 da	1 sa, 1 da	2 da 1 LS
Compatible with load sensing systems		–	–	–	–	–	Standard
Dead weight*	Approx. kg (lbs)	1,380 (3,042)	1,350 (2,976)	1,600 (3,527)	1,980 (4,365)	1,750 (3,858)	2,988 (6,587)
Tractor power	kW/hp	74/100	88/120	88/120	95/130	100/140	145/200
Area output (approx. minimum)	ha/h	7-10 (17.3 - 24.7)	8-11 (19.8 - 27.2)	9-12 (22.2 - 29.7)	10 - 14 (17.3 - 34.6)	10-15 (17.3 -37.1)	up to 14 (34.6)

*without front mower

** or load sensing. The standard control unit requires two extra double-acting spools.



EasyCut B 870 CV		EasyCut B 870 CR		EasyCut B 1000 CV		EasyCut B 1000 CR	
Collect		Collect		Collect		Collect	
8.70 (28'7")		8.70 (28'7")		9.30 - 10.10 (30'6" - 33'2")		9.30 - 10.10 (30'6" - 33'2")	
3.16 (10'4")		3.16 (10'4")		3.60 (11'10")		3.60 (11'10")	
2.78 (9'2")		2.78 (9'2")		2.95 (9'8")		2.95 (9'8")	
3.80 (12'6")		3.80 (12'6")		4.00 (13'2")		4.20 (13'9")	
3.80 (12'6")		3.80 (12'6")		4.00 (13'2")		4.00 (13'2")	
10		10		12		12	
4		4		4		4	
Standard		Standard		Standard		Standard	
Standard		Standard		Standard		Standard	
V-type steel tines		Rubber rolls or M-Rolls		V-type steel tines		Rubber rolls or M-Rolls	
64 (25")		2x25 (9.9")		64 (25")		2x25 (9.9")	
600/900		750		600/900		750	
-		-		-		-	
-		-		-		-	
Standard		Standard		Standard		Standard	
1,000		1,000		1,000		1,000	
1 sa, 1 da		2 da		1 sa, free return line**		1 sa, free return line**	
-		-		Standard		Standard	
2,690 (5,930)		3,380 (7,452)		3,400 (7,496)		3,880 (8,554)	
110/150		125/170		130/180		145/200	
9-11 (22,2 - 27,2)		9-11 (22,2 - 27,2)		10-14 (17,3 - 34,6)		10-14 (17,3 - 34,6)	

All specifications, weights and dimensions do not necessarily comply with standard specifications and are therefore not binding. Specifications are subject to change without notice.

Maschinenfabrik Bernard KRONE

Perfect in every detail

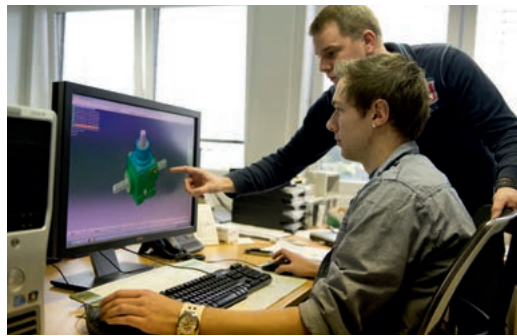

Innovative, proficient and close to our customers – these are the keywords that mark the philosophy of our family-owned company. As a forage specialist, KRONE manufactures disc mowers, tedders, rakes, forage wagons and silage trailers, round and square balers as well as the high-capacity and self-propelled BiG M mower conditioners and our BiG X forage harvesters. Quality made in Spelle – since 1906.

Your KRONE dealer



Maschinenfabrik Bernard KRONE GmbH & Co. KG

Heinrich-Krone-Straße 10
D-48480 Spelle

Phone: +49 (0) 5977 935-0
Fax: +49 (0) 5977 935-339

info.ldm@krone.de | www.krone.de