

iXtra 1100

iXter B10 - B13 - B16 - B18



iXter and iXtra: The Power of Simplicity!



Every Crop Deserves the Best Care

Kverneland Crop Care believes that technology makes a better future. We develop intelligent solutions for a better harvest and to increase crop yields, because every crop deserves the best care. Our smart solutions help the farmers work in an easier and more profitable way.

Kverneland Group is a leading international company developing, producing and distributing agricultural machinery and services, with a long history based on a clear vision: listen to the farmers and make their work easier.

Today Kverneland Group, part of Kubota Corporation from Japan, has production sites in Norway, Denmark, Germany, France, The Netherlands, Italy, Russia and China. The company has Sales Companies in 19 countries and exports to another 60 countries worldwide.



Field sprayers for farmers who protect their crops with less chemicals.

For modern farmers optimal spraying means to protect their crops against diseases, plagues and weeds with as few chemicals as possible. We want enough food for the world, with lower impact on the environment. Kverneland field sprayers enable precision farming and spraying at the right moment, on the right spot.

For the farmer, higher yields, lower costs and less waste.

Kverneland Rau iXter and iXtra A New Standard for Mounted Sprayers





iXter is the fruit of years of research and development in close collaboration with farmers: This is today the most advanced mounted sprayer range with focus on user friendliness and environmental protection.

Kverneland Rau iXter The Perfect Model for Your Needs!



Make Your Choice!



**HOSA 15m
"Z" folding
Alu-Liner boom**



**HC 18/20/21/24/27/28/30m
vertical folding
Steel-Liner booms**



Easy Hitch iXter Makes Life Easy



Gravity point close to the tractor for a maximum weight transfer

The **Easy Hitch** for iXter makes life simple for you:

1. Enough space to connect the PTO shaft and the hydraulic and electric cables.
2. Drive backwards to connect to the sprayer.
3. Lift up the sprayer.
4. An ingenious locking system secures the machine and shows the operator it has connected correctly.
5. Push in the storing legs and the iXter is ready to go!

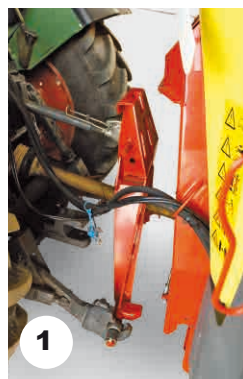

1



2



3

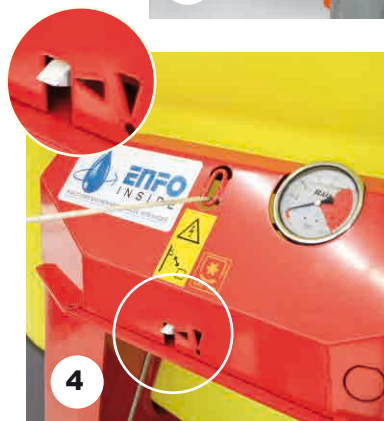

4

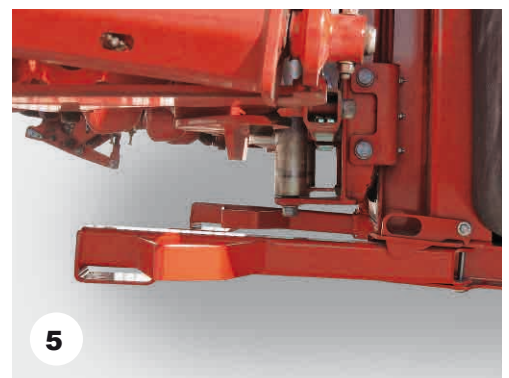

5

Easy Set Control Panel Leads You in the Right Direction



Full integration concept:

Nobody would expect all these functions so easily to hand. Better protection and integration is simply not possible! iXter is setting a new standard!



4-Position suction valve:

Position: main tank, clean water tank, suction fill and drain.

The **Easy Set** valve panel makes life easy by its intuitive operation. The controls are separated to a suction and a pressure side. The valves are well protected behind the door; this keeps your operational area free of dirt and pesticides.

4-Position pressure valve:

Position: filling main tank, spraying, Turbo agitation (optional), additional functions.

3-Additional pressure valves:

Functions: Tank cleaning nozzle, external cleaning (optional), liquid transfer (optional).



Fully Integrated Concept iXter for Easy Access

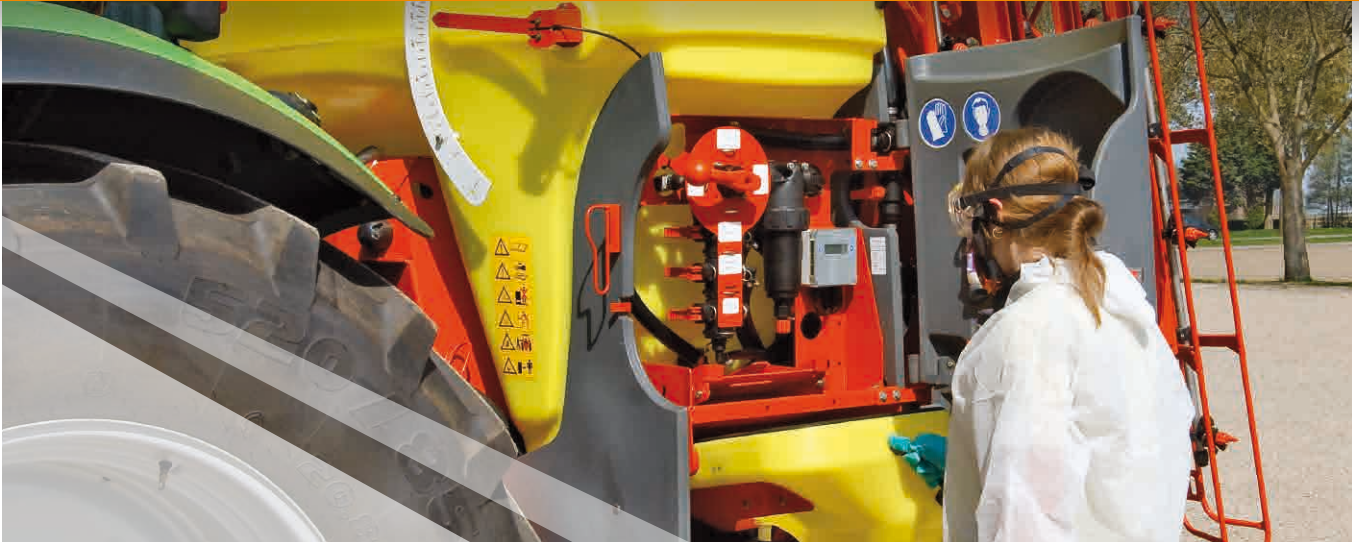

Filtration system:

Both suction and pressure filters are easy accessible for inspection and any subsequent cleaning, ensuring minimal contact with pesticide. The high capacity suction filter, filters the complete flow before the liquid enters the pump.



Parking frame iXter



The self cleaning pressure filter prevents blocking via a continuous flow keeping the filter mesh clean. The undissolved particles are returned into the tank until they are completely dispersed.



Transparent suction filter housing



Tank lid for filling or inspection:

The fully integrated step and handgrips allow safe access to the tank lid even on the 1800 liter tank.

iXclean Comfort and Pro

Every Litre Counts



iXclean Comfort

iXclean Comfort is a semi-automatic valve control system. The combination of an electrical level indicator and suction valve provides operator comfort and accuracy; automatic filling stops when the programmed level is reached, and remote control of all ENFO rinsing and priming functions are carried out from the cab! Simply prime the spray lines before you start and rinse them afterwards or even during an unexpected weather break, without having to leave the cab! ENFO is included as part of the standard specification of all Kverneland sprayers.

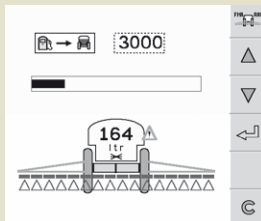

iXclean filling screen Focus II/ IsoMatch Tellus (coloured)



Electrical level indicator

An electrical level indicator provides actual tank volume to a spraying computer as well as via the external display on the valve panel.

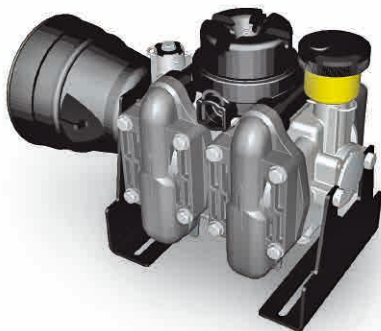

The new silent piston diaphragm pumps

Pumps are available with capacities of 150, 200 and 260 L/min. Liquid fertiliser resistant and capable of running dry without damage.

iXclean Pro

Advanced solutions come from iXclean Pro, with fully automatic, electric valve management on ISOBUS sprayers. It means all functions can be controlled from the cab.

Switching between filling, agitation, spraying, diluting, priming, rinsing and tank cleaning, is extremely easy: just push the button!

In addition to auto filling, iXclean Pro offers also a fully automatic multi-step rinsing and cleaning program for the entire sprayer. Pushing one button a comprehensive cleaning process including all lines too starts, that takes just a few minutes and uses minimal amounts of clean water.



iXclean Pro screen Focus II/IsoMatch Tellus (coloured)



It is so thorough, that residue levels after automated cleaning, are below 1%. iXclean Pro for filling or cleaning: making every litre count!

Easy Operation

Filling is Easy, Clean and Safe



Chemical inductor:

The graduated chemical inductor with a capacity of 20 litres is mounted on rails and fully integrated in the frame.

In storage position the inductor is sealed against the top plate and no cover is needed. The rotating canister cleaning nozzle releases the water when pushed downwards. The circular rinsing system is no add on: it is part of the design!



18 liter hand wash tank:

Everything is available to keep your hands clean. A storage place for gloves, liquid soap and the hand wash tank itself is integrated in the door. To prevent contamination, washings can be caught in the chemical inductor hopper.



Put the Turbo in the Tank!

The standard return flow agitation with its unique agitation tube is keeps the tank mixture agitated. To empty the main tank completely it can be electrically switched off during spraying.

The turbo agitation system (optional) allows powerful mixing during preparation of the mixture. This is especially helpful when powders are used or after sedimentation during a longer period of interruption.

The entire pump flow is used to power 6 injector nozzles.

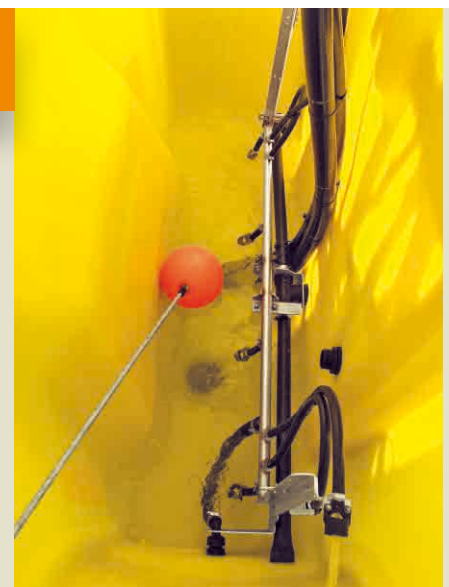

Hydrant filling:

The optional 2 inch hydrant filling device allows filling under pressure at high capacity.

An anti return valve avoids return flow to the water source.



Filling via the suction hose:

External aspirated water is filtered first by the filter on the hose and then by the suction filter. In parallel you can already use the chemical inductor to add and premix chemicals.

Outside cleaning set (optional):

15m of hose, a brush with insert for soap, all linked to the pressure side of the pump, allow cleaning in the field with water from the 180 L clean water tank.



180 liter clean water tank

The sprayer can be cleaned in the field with water from the clean water tank. Easy access to fill the tank via the opening in the cover.



Clean cloth locker

The clean cloth locker, which is integrated in the clean water tank, allowing you to keep your safety and cleaning equipment or tools with you on the sprayer.

ENFO Inside

We Care about Your Crop!

Environmental FOCUS: ENFO priming and rinsing system is standard on all our spray computers

This smart technology optimizes filling and cleaning of the spray lines. Accurate application, no waste of chemicals and saving water are the benefits for you and your environment.



Automatic Priming of spray lines: before spraying starts the spray lines are filled with chemicals exactly up to the nozzle by automatic section shut off. This means no waste of chemicals and accurate application from the first moment!

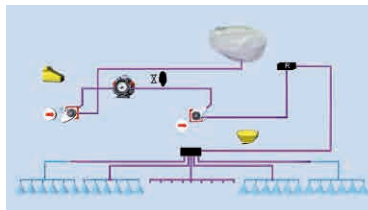

Automatic Rinsing of spray lines: after finishing or interruption, the pesticides are automatically flushed out of the spray lines. This means using up to the last litre of mixture and rinsing the spray lines with a minimum of clean water consumption.

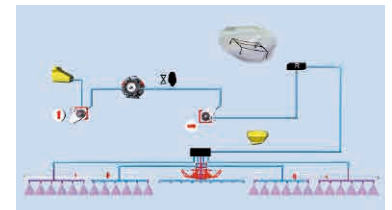

Sprayer Test Hall for Top Quality!



A certified test crew is testing every iXter, and of course all other sprayers, leaving the factory in our own test hall to meet the latest environmental regulations. Our testers are certified for all of the following test procedures.



NSTS: National Sprayer Testing Scheme is the relevant authority in UK for sprayer homologation.



JKI: Official homologation for Germany, delivered by the Federal Biological Research Centre of Germany, now JKI Institute.



ENTAM: Homologation is in process. ENTAM is the European Network for



SKL: Official homologation for Benelux, delivered by the SKL foundation for agricultural machinery in Wageningen.



NY: Official homologation for Norway, delivered by the Norwegian Food and Safety Authority.

Testing Agricultural Machines. JKI of Germany and Cemagref of France are among others, official members of ENTAM.

EC, FMC, Focus II Make Spraying Easy



Remote Control EC:

- All in one remote control
- Spraying on/off functions including up to 7 sections and two boarder nozzle switches
- Agitation shut off
- Pressure control
- Pre-select hydraulic boom functions



FlowMate Control FMC:

- Basic spray computer
- Extremely simple to operate
- Very compact by integration of all spraying and hydraulic functions
- Controlling the unique ENFO functions
- Integrated nozzle advice
- Field memory for 25 different fields

Focus II: One for All!

iXter is also available as ISOBUS 11783 compatible sprayer. It can be controlled by the Kverneland Group Focus II, IsoMatch Tellus ISOBUS terminal or any tractor ISOBUS compatible terminal. The Switchbox provides all spray and hydraulic switches.

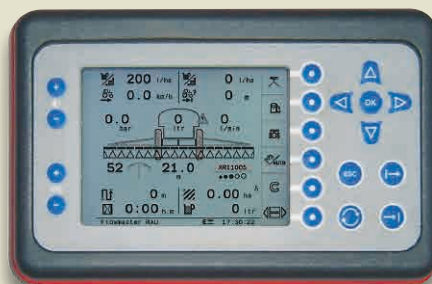

Switchbox

Operates spray and boom functions by intuitive layout for maximum comfort and short reaction times.

Focus II is the professional Kverneland Group Terminal which fits our sprayers, spreaders, seeders, precision seeders, loader wagons, balers, etc.

- Large clear digital display
- All relevant parameters visible at a glance
- Field memory for 40 different fields
- RS232 serial port to external sources



Serial port to connect external sources.



IsoMatch Tellus

The Next Generation Terminal!



The IsoMatch Tellus is your powerful platform for precision farming applications and future growth.



The IsoMatch Tellus is the first Universal Terminal with the capability to view and operate 2 different ISOBUS interfaces at once. This allows direct control of 2 implements at the same time, use GEOcontrol or display a camera view, without switching screens.

- Two ISOBUS interface screens
- Large 12.1" colour touch screen
- Intuitive operation
- Basic DOC registration program to save operational information directly to USB
- Four USB slots for quick data exchange (e.g. ISO-XML field maps, PDF), wireless USB stick or USB to serial cable for additional sensors
- Built in PDF reader: store and read any PDF document such as operator manuals
- RS232 connection for GPS receivers or sensors
- Internet connection via a wireless USB stick or router
- Integrated web browser



Switchbox

Operates spray and boom functions by intuitive layout for maximum comfort and short reaction times.

IsoMatch GEOcontrol Brings Clear Benefits

IsoMatch GEOcontrol is an additional software application within the IsoMatch Tellus that helps you to control all ISOBUS compatible Kverneland Group machines such as sprayers, spreaders and seeders! Combined with a GPS receiver it fulfils the future needs in terms of easy, smart and efficient farming. Easy operation and driver comfort due to the automatic implement control. You can stay focused on driving, while IsoMatch GEOcontrol lightens the workload. Reduced overlap and redundant tracks results in increased quality of work and efficiency by cost savings in time, fuel, fertiliser, pesticides and seeds.

Section control

Automatic switching on and off implement sections on headlands, boundaries and already covered areas to minimise overlap.

Variable rate control

Automatically adjusts the implement application rate based on input from the field prescription.

Documentation

Saves all operational job data and field maps for exchange via USB to farm management information systems.

Manual guidance

- Advised driving position using guidance lines (straight, curved or combined) in the field and on headlands
- Extendable using the optional IsoMatch InLine light bar, to place guidance in line of sight
- Smart boundary recording: independent from the working width, even without any implement corrected
- Boundary shrinking: create new inner boundaries by setting the desired width of the headland
- Manual guidance for all operations, includes non-electric or non-ISOBUS implements. e.g. cultivators, mowers, tedders etc.
- Headland control: create headland boundary and headland guidance lines tedders etc.

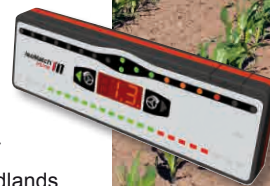

ISOMATCH GEOcontrol

- Easy and comfort of operation, due to not having to manually switch on or off sections or change the application rate. You can focus 100% on the driving in the field.
- More efficient work and avoiding overlap leads to cost savings of 5-10% on e.g. fertiliser, pesticides and seed. Better growing conditions and the increased yield.
- With IsoMatch GEOcontrol, working at night time becomes very easy. IsoMatch GEOcontrol reduces the workload considerably.

Starguide IV

Future Becomes Reality

Starguide IV: Automatic GPS section control and guidance by D-GPS

Those who have used it will never go back. Starguide IV will change your spraying days forever: spray around the headland and the Starguide IV will control the spray sections automatically as you cover the remainder of the field.

The Starguide IV enables you:

- Spraying in the dark
- Accurate spraying by full overlap control
- Increased operator comfort
- Cost savings by reduced overlap

Starguide IV is easy to operate: after spraying a field boundary the overlap and headland management are controlled for the rest of the field!



In addition the Starguide IV also includes the following features:

- Easy to operate, intuitive 5.7" colour touch screen
- Field view with covered areas and overlap
- Single and double overlap in different colours
- GPS status warnings
- USB slot for data export in different formats
- RXA-30 antenna

Boom Guide

Make Your Life Easy

Maintain your boom height!

ISO Boom Guide is our automatic boom height control system that helps you to maintain your chosen spraying height. Ultrasonic sensors control the sprayer's hydraulics to guide the boom over the crop canopy or soil surface. This unique sensor technology provides excellent guidance in many different and challenging field conditions, making it easier for the operator to stay focussed on spraying.

Boom Guide Comfort

The two ultrasonic sensors on the boom can control the spray height via the central slope correction and boom lift functions. This cost-effective system is suited to gentle slopes, uneven crop conditions and lower driving speeds.

Boom Guide Pro

This advanced system uses three ultrasonic sensors to control left- and right-hand boom sections independently for the ultimate guidance in the most challenging field conditions. It can deliver positive and negative lateral movement on each side of the boom to follow the contours in every condition!

Advantages of Boom Guide:

- Less drift: more constant and correct nozzle height
- Increased capacity: allows faster spraying speeds, also in the dark
- Driver comfort: less fatigue with easier focus on spraying
- Integrated ErgoDrive functionality: automatic lifting and lowering on headland turns
- Crop and Soil mode selection: closely follow the top of a closed canopy or of follow the soil surface in an uneven, open canopy or row crop situation
- Safe transport: ultrasonic sensor automatically fold with boom in its transport position
- ISOBUS compatible: easy plug and play operation with ISOBUS compatible (tractor) terminals



Boom Guide Comfort

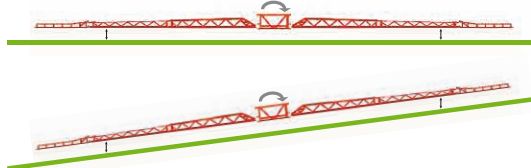

Boom Guide Pro

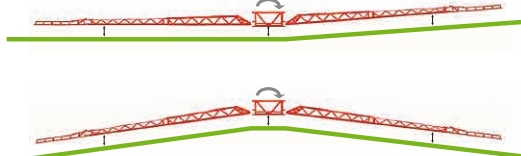

iM FARMING

smart efficient easy **FARMING**



iM FARMING makes mechanical work smarter, more efficient and simpler. The use of ISOBUS technology makes machinery easier to connect, operate, control and monitor.

Maximum return from your investments, that is the core of Kverneland Group's iM FARMING solutions. iM FARMING describes and presents our offering on ISOBUS machines and solutions for electronic steering of implements. All aimed at giving an insight into the benefits and efficiency of our extensive offering, adapted to your requirements. That is what you can expect from Kverneland Group. Now and in the future. Intended to make life easier for farmers.

► Precision Spraying

Do you also want to spray a less as possible, at the right moment, at the right spot? That's why we have developed IsoMatch GEOcontrol. This smart and modern technology prevents waste of expensive chemicals and ensures perfect alignment on the headlands and in the triangles. Overlap is a thing of the past, which not only saves on crop protection agents, it also ensures a more equal crop yield and quality. Each plant receives exactly the same amount of crop protection.

► ISOBUS compatible

For even more operator comfort we have some other features available on our sprayer range. Boom Guide is an ultrasonic boom height control system operating the boom lift, slope correction and independent slope correction cylinders. iXclean Pro is our full electrical valve management system where all the functions can be controlled from the operators seat.

- 100% ISOBUS compatible
- Minimise overlap
- Parcel registration and data storage
- Up to 10% saving on pesticides
- Automatic switching ON/OFF through IsoMatch GEOcontrol



iM Ready
ISOBUS THAT'S WHAT I CALL SMART WORKING

iM inControl
ONE TERMINAL TO CONTROL ALL OF MY ISOBUS MACHINES

iM Global
WITH GPS IT'S SIMPLE AND MORE EFFICIENT

iM Intelligent
EASY, I JUST USE INTELLIGENT MACHINERY

IsoMatch GEOcontrol and SPRAYERcontrol

Would you like to have some clear benefits? You just have to buy the IsoMatch Tellus Terminal, a license and one of our ISOBUS compatible sprayers. Save 5% to 10% on your spraying costs and control and optimize your spraying process with IsoMatch GEOcontrol. Working at night? No worries, be at the forefront of environmental constraints. It is now possible with our applications!



iXtrack



iXter



Ikarus S



IsoMatch InLine



Manual guidance



Section control



Variable rate control



Documentation

► IsoMatch GEOcontrol

Once you have an IsoMatch Tellus Terminal you can simply unlock the IsoMatch GEOcontrol application (after you have purchased a license key) and you get access to all precision farming applications: automatic switching on and off implement sections, variable rate control, manual guidance and easy exchange of data between the IsoMatch Tellus and your PC. To get familiar and convince yourself about the customer benefits of IsoMatch GEOcontrol you are entitled to 10 hours free of use of the application, before purchasing a license. No doubt for us, you will quickly become an enthusiastic follower of this new technology!



IsoMatch Global



IsoMatch Eye

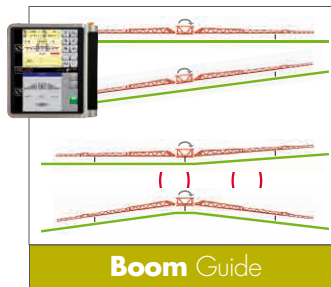

Boom Guide



iXclean Pro



iXtra Comfort or iXtra Pro Front Tank So Much More Than Just Extra Volume



Easy hitching and unhitching

iXtra Comfort and iXtra Pro

The iXtra front tank is available in two different versions. The iXtra Comfort with manual control of the EasySet control panel on the iXter as well as the control panel of the iXtra. The second version is the iXtra Pro. This is the ISOBUS version of the front tank, the operator gets full control over all functions from the tractor seat including automatic level management. Front and rear tanks will then be emptied in equal proportion for optimum weight distribution.



Multi-Tank-Management

The innovative iXtra concept offers much more than just extra tank volume. In combination with the iXter mounted sprayer, the iXtra front tank provides a total volume of around 3000 litres, making the iXter-iXtra combination a serious alternative to a self propelled sprayer. With tractors able to carry much higher loads on their rear linkages, the need for ballast weight on the front of the tractor is essential. With a nominal volume of more than 1100 litres, the iXtra is that front end weight, adding stability to your tractor, but only when needed!

The iXtra concept with combined functions gives you more flexibility while spraying:

- One-tank approach: filled with spray liquid it boosts overall tank capacity by 60%.
- Two-tank approach: filled with two different tank mixes, the front and rear tanks can be used as two independent spray tanks.
- Reservoir approach: filled with clean water the iXtra front tank can be used as a reservoir for later use, for example in another field or crop.



Control panel iXtra Comfort



Control panel iXtra Pro

Easy to fit, simple to unhitch

The iXtra front tank uses the functions of the iXter sprayer when filling and spraying. This avoids the need - or additional cost - for a separate induction hopper or spray pump for the front tank. All the necessary controls are conveniently located on the sprayer and are operated from the EasySet valve panel on the iXter. Without a front PTO shaft or hydraulic hoses, hitching and unhitching the iXtra is extremely simple: it uses only two hoses with KAMlock connections and an electrical cable - it really is that simple!

HPT Boom

The Proven Package



The HPT boom is a very compact boom with a low centre of gravity and a reduced transport height. The protective bars fitted as standard effectively protect the spray nozzles from damage.

Boom features:

- Protective bars for spray nozzles
- Hose guidance
- Mono or quadro jets nozzle holders
- Electro-hydraulic valves for half boom folding
- Electro-hydraulic slope correction



HPT 18 m
10,2 m
2,7 m

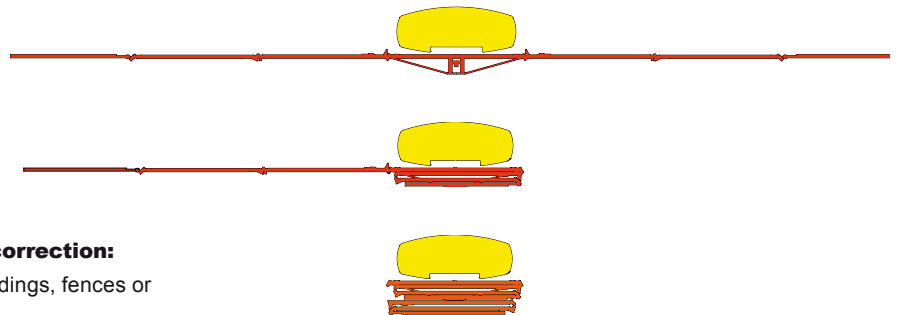

One side folding becomes possible with slope correction:

this feature allows one-side spraying along hedges, buildings, fences or other obstacles.

HPT 18 5 sections

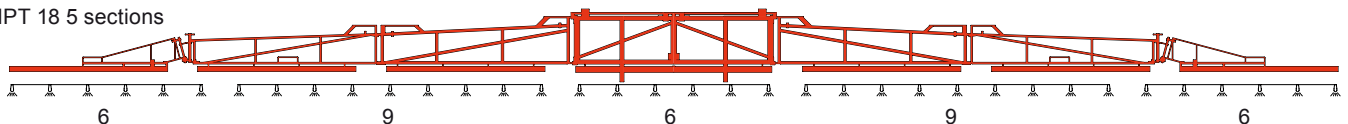

HOSA Boom

Go Fast in Difficult Fields



Innovations to make life easy:

The HOSA is a unique boom of the Alu-Liner family having an advanced Z-folding principle: the lateral movement enables you to quickly reduce boom width and pass obstacles in the field. The aluminium profile is designed for maximum resistance. No welding provides remarkable strength, the anodised hardened surface protects against scratches and corrosion.

- Z-folding aluminium boom
- One-side spraying
- 2,50m transport width
- Heavy construction, light weight
- Profile integrated nozzle protection
- Smooth surface for easy cleaning
- Mono or Tri jets
- Central locking of pendulum system



Transport locking



Hydraulic locking pendulum system

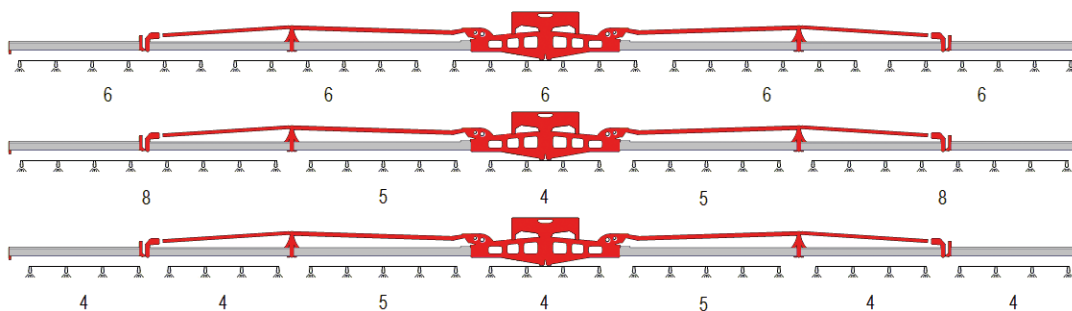

HOSA 15 5 sections

HOSA 15 5 sections v1

HOSA 15 7 sections



One side spraying

Safety tip-end



HC Boom

The Versatile Boom



Safe on the road
The 2.50m transport width means that even narrow roads and gateways are no obstacle.



Made for high speed:

The HC is the multi-talented boom in the Steel-Liner family. The triangular steel construction and the unique anti yaw system allow high speed even in very difficult conditions.

Multiple folding possibilities:

The HC boom is giving you the functionalities for one side folding, symmetrical reduction and asymmetrical reduction depending of the choice for the electric hydraulic command.

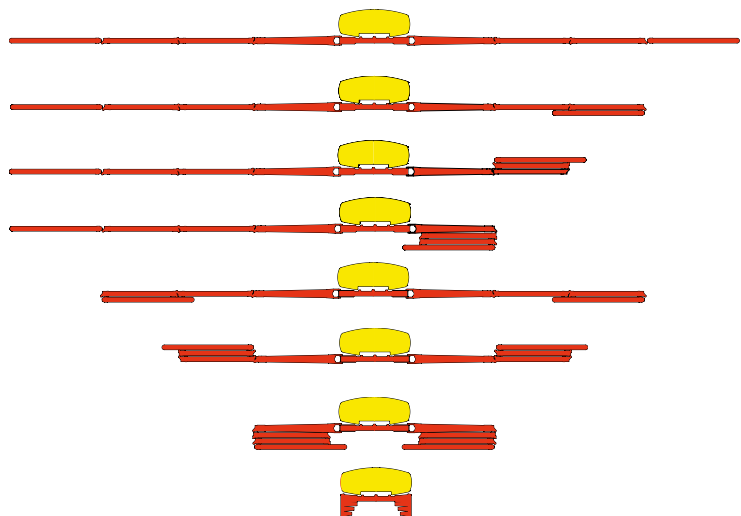



Special bottom profile for full nozzle integration and protection.



Anti yaw system for independent damping left right for uninfluenced boom behaviour.

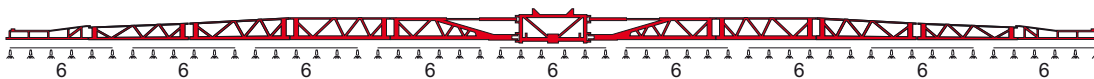

HC27m - 9 sections



HC28m - 9 sections

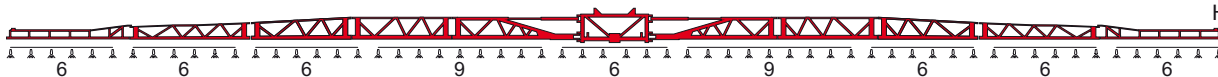

HC30m - 9 sections

HC boom (m)	Sections	Section deviation
18	5	6-9-6-9-6
18	7	5-5-6-4-6-5-5
20	5	8-8-8-8-8
20	7	5-6-6-6-6-6-5
20	7	4-4-8-8-8-4-4
20	9	4-4-4-6-4-6-4-4-4
21	5	9-8-8-8-9
21	7	6-6-6-6-6-6-6
21	7	7-7-5-4-5-7-7

HC boom (m)	Sections	Section deviation
21	9	5-4-4-6-4-6-4-4-5
24	7	6-6-9-6-9-6-6
24	9	6-5-5-6-4-6-5-5-6
27	7	6-9-9-6-9-9-6
27	9	6-6-6-6-6-6-6-6-6
28	7	8-8-8-8-8-8-8
28	9	4-6-6-9-6-9-6-6-4
28	9	7-6-6-6-6-6-6-6-7
30	9	6-6-6-8-6-8-6-6-6

Kverneland Rau iXter and iXtra

Technical Specifications

Models	Kverneland Rau iXter			
	B10	B13	B16	B18
1. Tank size				
Nominal / maximum main tank capacity	1000 l / 1100 l	1300 l / 1450 l	1600 l / 1800 l	1800 l / 2000 l
Clean water tank / Hand wash tank	180 l / 18 l	180 l / 18 l	180 l / 18 l	180 l / 18 l
Chemical inductor with opening of 40x40 cm	30 l	30 l	30 l	30 l
2. Empty weight (total machine incl. boom)				
... with HPT 18 m	1234 kg	1246 kg	1259 kg	1268 kg
... with HOSA 15 m	1048 kg	1060 kg	1073 kg	1082 kg
... with HC 18 m	1371 kg	1383 kg	1396 kg	1405 kg
... with HC 20 m	1415 kg	1427 kg	1440 kg	1449 kg
... with HC 21 m	1421 kg	1433 kg	1446 kg	1455 kg
... with HC 24 m	1459 kg	1471 kg	1484 kg	1493 kg
... with HC 27 m	1619 kg	1633 kg	1647 kg	1670 kg
... with HC 28 m	1634 kg	1648 kg	1662 kg	1675 kg
... with HC 30 m	1647 kg	1661 kg	1675 kg	1685 kg
3. Measurements				
Width (total machine incl. boom)	HPT18 m = 2,75 m - HOSA + HC 18-30 m = 2,50 m			
Height (total machine incl. boom)	HPT = 2,65 m - HOSA = 2,85 m - HC = 3,30 m			
Length (total machine incl. boom)	HPT18 m = 1,65 m - HOSA + HC18 m = 1,45 m - HC20-24 m = 1,65 m - HC27-30 m = 2,10 m			
4. Pumps				
Piston-diaphragm pump 150 l/min or 200 l/min or 260 l/min	▲ 150 or 200 or 260 l/min			
5. Electronics				
5.1. Remote control				
EC 5-section 3-way-valves, for pre-selection hydr. (incl. EC control box)	▲ ¹ not for HC			
5.2. Basic spray computer				
FMC 5-section 2-way-valves, for pre-selection hydraulics (incl. FMC control box)	▲ ²			
FMC 7-section 2-way-valves, for pre-selection hydraulics (incl. FMC control box)	▲ ³			
FMC 9-section 2-way-valves, for pre-selection hydraulics (incl. FMC control box)	▲ ⁴			
FMC 5-section 2-way-valves, for oilcircuit hydraulics (incl. FMC control box)	▲ ⁵			
FMC 7-section 2-way-valves, for oilcircuit hydraulics (incl. FMC control box)	▲ ⁶			
FMC 9-section 2-way-valves, for oilcircuit hydraulics (incl. FMC control box)	▲ ⁷			
5.3. ISOBUS electronics				
FMA 5-section 2-way-valves, for oilcircuit hydraulics ISOBUS (excl. control box)	▲ ⁸			
FMA 7-section 2-way-valves, for oilcircuit hydraulics ISOBUS (excl. control box)	▲ ⁹			
FMA 9-section 2-way-valves, for oilcircuit hydraulics (excl. control box)	▲ ¹⁰			
5.3.1. Controls for ISOBUS electronics				
Switchbox	▲ ¹			
FOCUS II and Switchbox	▲ ²			
ITH (connection cable tractor side)	●			
5.3.2. ISOBUS controls for ISOBUS electronics				
Switchbox	▲ ¹			
IsoMatch Tellus and Switchbox	▲ ²			
Joystick for IsoMatch Tellus and Switchbox	●			
6. Other basics				
Chemical inductor	▲			
PTO shaft 6-splines	▲			
Quick hitch, Frame stand, Clean water tank, Hand wash tank, Manometer, Mechanical level indicator, Tank inside cleaner, Drain (tank empty by gravity)	standard			
7. Options (factory fitted)				
Electrical level indicator	● only FMC/FMA electronic			
iXclean Comfort (incl. electrical level indicator)	● only FMC/FMA electronic			
iXclean Pro (incl. electrical level indicator)	● only FMA electronic			
Boom Guide Comfort or Pro (only possible in combination with FMA electronics and IsoMatch Tellus)	● only FMA electronic			
8. Accessories (also loose available)				
TURBO agitation (high pressure agitator)	●			
Protection curtain	●			
Hydrant filling connection 2"	●			
Filling Hose 8m 2" (for sucking from external)	●			
Non return valve for Filling hose	●			
Float for Filling Hose	●			
Clean water tank filling connection 1" at Easy Set valve panel	●			
Outside cleaner	●			
Pump out connection	●			
Parking frame	●			
Battery cable 3 pin (only for EC/FMC, if no power connector at tractor)	●			
CAN extension cable 6m (only for FMC)	●			
Second quick hitch	●			
▲ ¹ - ▲ ¹⁰ - = one of these choices must be selected, ▲ = must be selected, ● = option, free to select				



The steel parts of our sprayers are protected by a **Duracoat powder paint coating**. The result is a sealed extremely hard wearing and attractive finish.

All different tank volumes: 1000, 1300, 1600 and even 1800 liter are build on the same strong and robust frame.

The iXter frame is made out of **Domex steel**. This type of steel is combining high strength and good formability which results in the heavy duty frame as we are using today for our iXter!



Booms	HPT	HOSA	HC	HC
Type	18	15	18 / 20 / 21 / 24	27 / 28 / 30
1. Basic boom functionality				
Working width (maximum)	18 m	15 m	18 / 20 / 21 / 24 m	27 / 28 / 30 m
Material	Steel	Aluminium	Steel	Steel
Transport position	Package horizontal	Vertical	Vertical	Vertical
Folding drive	Hydraulically	Hydraulically	Hydraulically	Hydraulically
2. Spray sections				
Standard	5	5	5 / 7 / 7 / 7	9 / 9 / 9
Alternative 1 (two sections more than standard)	7	7	7 / 9 / 9 / 9	- / - / -
Alternative 2 (two sections less than standard)			5 / 5	7 / 7 / 7
3. Spray jets				
Monojets	▲ ¹	▲ ¹	▲ ¹	▲ ¹
Trijets		▲ ²	▲ ²	▲ ²
Quadrojets	▲ ²			▲ ³
4. Accessories (also loose available)				
Nozzle protection extension (recomended for injector nozzles)	●	Integrated	Integrated	Integrated
Road lights	●	●	●	●

	Kverneland Rau iXtra	
Technical Specifications	1100 Comfort	1100 Pro
Nominal tank capacity (l)	1100	1100
Maximum tank capacity (l)	1300	1300
Clean water tank capacity (l)	2x65	2x65
Empty weight (kg)	221	223
Front linkage	Cat II	
12V electrical pump capacity (l/min)	25 (for cleaning & agitation)	
Automatic agitation stop	Standard	
2 rotating cleaning nozzles	Standard	
2 injector nozzles for agitation	Standard	
Autonomous suction filter	Standard	
Level indicator	Mechanical	Electrical
Control panel	Manual	Electrical (ISOBUS)
Accessories (also loose available)		
Traffic lights	●	●
Transport rollers	●	●
Deflector decals	●	●
IsoMatch Eye (camera)	-	●
Compatibility on iXter with adaptation set		
FMC	●	●
FMA-ISO (Focus II or IsoMatch Tellus)	●	●
iXclean Comfort	●	●
Xclean Pro	-	●

▲¹ - ▲² - ▲³ - = one of these choices must be selected, ▲ = must be selected, ● = option, free to select

Information provided in this brochure is made for general information purposes only and for worldwide circulation. Inaccuracies, errors or omissions may occur and the information may thus not constitute basis for any legal claim against Kverneland Group. Availability of models, specifications and optional equipment may differ from country to country. Please consult your local dealer. Kverneland Group reserves the right at any time to make changes to the design or specifications shown or described, to add or remove features, without any notice or obligations. Safety devices may have been removed from the machines for illustration purposes only, in order to better present functions of the machines. To avoid risk of injury, safety devices must never be removed. If removal of safety devices is necessary, e.g. for maintenance purposes, please contact proper assistance or supervision of a technical assistant.

© Kverneland Group Nieuw-Vennep BV

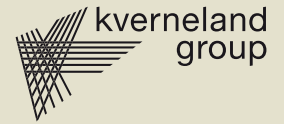

Kverneland Group

Kverneland Group is a leading international company developing, producing and distributing agricultural machinery and services.

Strong focus on innovation allows us to provide a unique and broad product range with high quality. Kverneland Group offers an extensive package aimed at the professional farming community, covering the areas of soil preparation, seeding, forage and bale equipment, spreading, spraying and electronic solutions for agricultural tractors and machinery.



Original Spare Parts

Kverneland Group spare parts are designed to give reliable, safe and optimal machinery performance - whilst ensuring a low cost life-cycle. High quality standards are achieved by using innovative production methods and patented processes in all our production sites.

Kverneland Group has a very professional network of partners to support you with service, technical knowledge and genuine parts. To assist our partners, we provide high quality spare parts and an efficient spare parts distribution worldwide.



 **Watch us on YouTube**
www.youtube.com/kvernelandgrp

Kverneland Group
N-4355 Kverneland
Norway
Phone: + 47 51 42 94 00
Fax: + 47 51 42 94 01
contact@kvernelandgroup.com

 **Like us on facebook**
www.facebook.com/KvernelandGroup
www.facebook.com/iMFarming

Kverneland Group Canada Inc.
1200, rue Rocheleau
Drummondville (Québec), J2C 5Y3, Canada
Phone: +1 819 477 2055
kvcanada@kvernelandgroup.com

 **Follow us on Twitter**
[#KvernelandGroup](https://twitter.com/KvernelandGroup)
[#iM_Farming](https://twitter.com/iM_Farming)

www.kverneland.com

