

Ikarus S28 – S38
HSS and HC Boom



Stay on Track with Ikarus S



Every Crop Deserves the Best Care

Kverneland Crop Care believes that technology makes a better future. We develop intelligent solutions for a better harvest and to increase crop yields, because every crop deserves the best care. Our smart solutions help the farmers work in an easier and more profitable way.

Kverneland Group is a leading international company developing, producing and distributing agricultural machinery and services, with a long history based on a clear vision: listen to the farmers and make their work easier.

Today Kverneland Group, part of Kubota Corporation from Japan, has production sites in Norway, Denmark, Germany, France, The Netherlands, Italy, Russia and China. The company has Sales Companies in 19 countries and exports to another 60 countries worldwide.



Field sprayers for farmers who protect their crops with less chemicals.

For modern farmers optimal spraying means to protect their crops against diseases, plagues and weeds with as few chemicals as possible. We want enough food for the world, with lower impact on the environment. Kverneland field sprayers enable precision farming and spraying at the right moment, on the right spot.

For the farmer, higher yields, lower costs and less waste.

Kverneland Rau Ikarus S

Ikarus S - Evolution for Simplicity!





Ikarus S is the evolution of the well known and proven Ikarus technology. The whole spraying circuit and operation centre has been completely redesigned for easy operation and user friendliness. Ikarus S is also suitable for exclusive high-tech features including ISOBUS communication systems.

Kverneland Rau Ikarus S Make Your Choice!



Ikarus S28 with HSS 27m horizontal folding Steel-Liner boom



Ikarus S38 with HC 24m vertical folding Steel-Liner boom

The Ikarus S is available in 2800 or 3800 litre tank with HSS 18-20-21-24-27-28-30m horizontal folding steel-liner booms or with HC 18-20-21-24-27-28-30m vertical folding steel-liner booms.

Easy hitching, easy following



Top linkage and Autotrac track following system

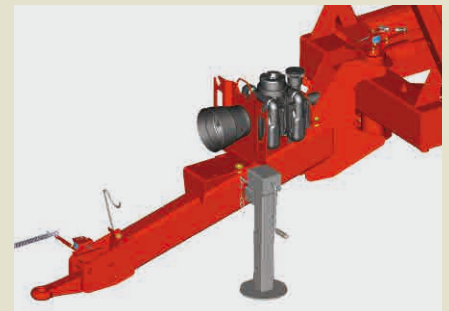

Low linkage and Autotrac track following system

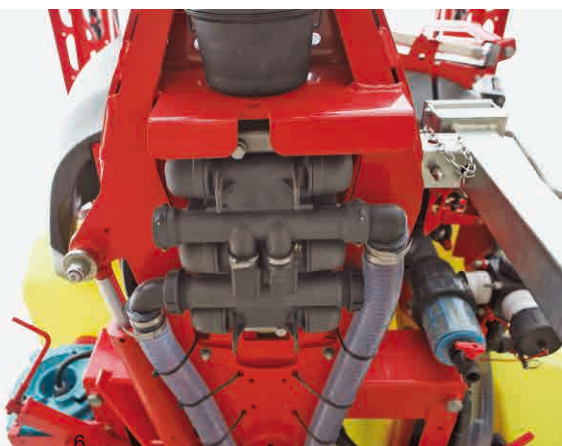

Perfect integration of the pump inside the drawbar

- PTO shaft is always aligned with the pump and tractor shaft
- Easy service access to the pump
- Perfect hose fitting and big ground clearance

Drawbar solutions

- Hitch or top linkage fixed
- Auto steering track following system (oil circuit required) Towing eye Ø 40/50mm or ball coupling Ø 80mm available.

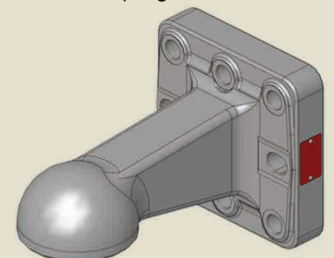



Fixed axle with hydraulic brakes



Sliding axle with air brakes



Sliding axle with suspension

Axle options to suit all individual requirements

- Fixed axle 1.50 - 1.80m without brakes. Track adjustment by wheel rim position.
- Fixed axle 1.50 - 1.80m with brakes (up to 25 km/h). Track adjustment by wheel rim position.
- Sliding axle 1.50* - 2.25m with brakes (up to 40 km/h).
- Sliding axle 1.50* - 2.25m with suspension and brakes (up to 40 km/h).

All brake axles have a mechanical hand brake and can receive hydraulic brakes or pneumatic brakes as an option.

*1.60m in combination with suspended axle and air brakes

Axle width (mm)	Rim turned to inner side (Pos. 1)	Rim turned to outside (Pos. 2)
1650	1500	1800
1750	1600	1900
1850	1700	2000
1950	1800	2100
2100	1950	2250

Track width adjustment

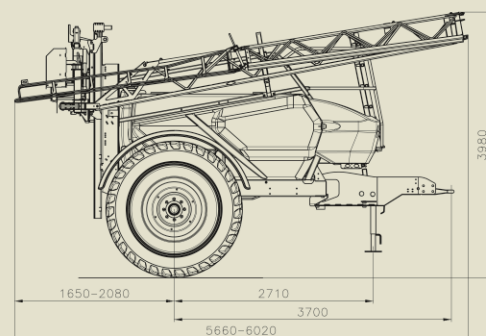
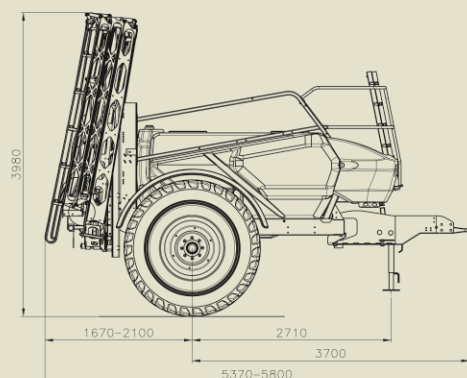
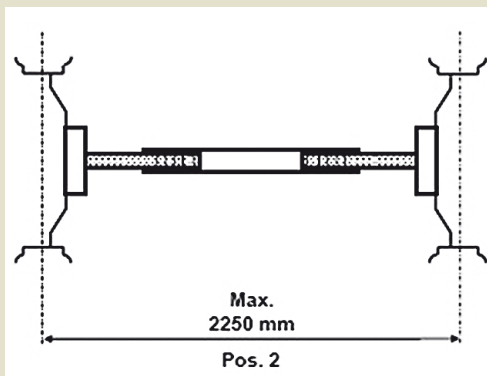
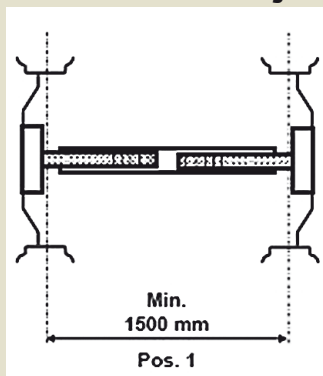

Extremely compact design

- Very short turning radius at headlands
- Precise track following on tight turns
- Large capacity, 3800-litre tank in a compact chassis

Easy Set Valve Panel Leads You in the Right Direction



Fully Integrated concept:

Nobody would expect all these functions to fall so easily to hand. Better protection and integration is simply not possible. Ikarus S is setting a new standard.



Four-Position suction valve:

Position: main tank, clean water tank, suction hose, additional functions

Quick filling*:

Higher filling speed

*Not in combination with iXclean Comfort



Easy Set valve panel makes life easy by its intuitive operation. The controls are separated in a suction and a pressure side. The valves are well protected behind the door; this keeps your operational area free of dirt and chemicals.

Four-Position pressure valve:

Position: filling main tank, spraying, turbo agitation, additional functions.

Three extra pressure valves:

Functions: tank cleaning, external cleaning, pump out connection

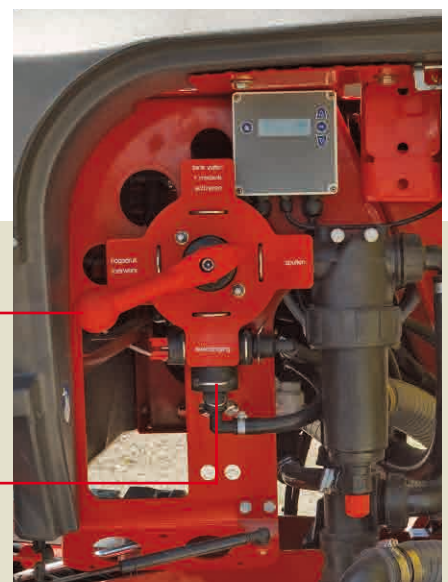

Easy Access

Ikarus S for Easy Access

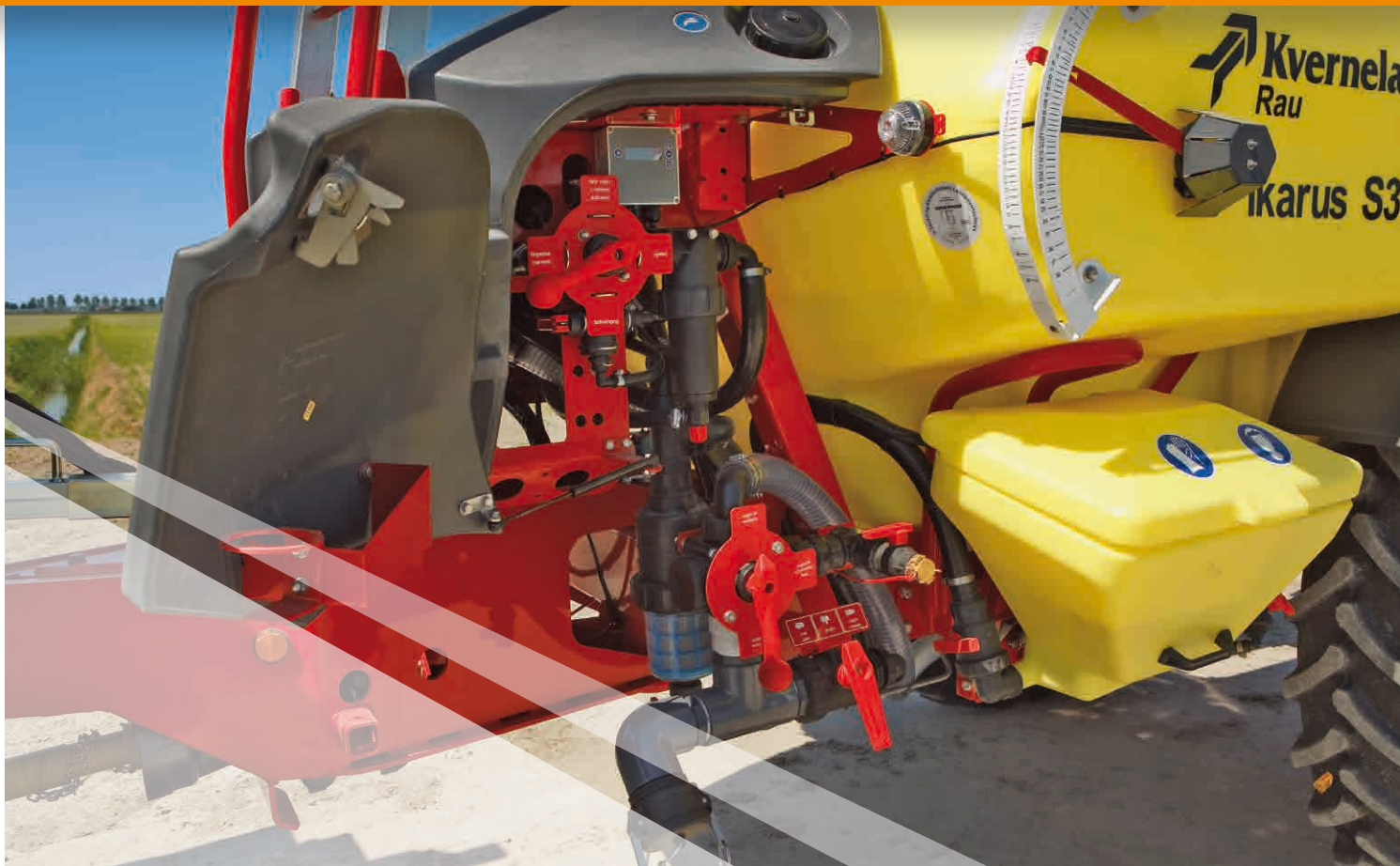

Electrical level indicator

The optional electrical level indicator provides the actual tank volume to the spraying computer, as well as via the external display on the valve panel.

The door gives easy access to the valve panel and operator functions. Special attention has been put on service friendliness by easy access and quick-fit hose connections.

The Easy Set valve panel makes the operator's life easy: with only one four-way suction valve you can select the water flow, and with the other four-way pressure valve you select the action.

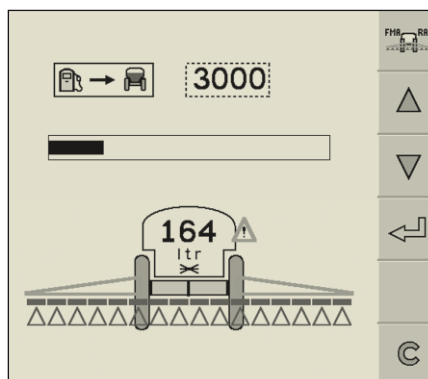

iXclean Comfort filling screen Focus II/IsoMatch Tellus (coloured)



Platform

Ikarus S offers a generous and safe platform giving access to the man hole by means of a sliding aluminium ladder.

iXclean Comfort and iXclean Pro Every Litre Counts



Options

- Hydrant fill connection with anti- return valve
- Pump out connection for liquid fertiliser



iXclean Comfort

iXclean Comfort is a semi-automatic valve control system. The combination of an electrical level indicator and suction valve provides operator comfort and accuracy; automatic filling stops when the programmed level is reached, and remote control of all ENFO rinsing and priming functions are carried out from the cab! Simply prime the spray lines before you start and rinse them afterwards or even during an unexpected weather break, without having to leave the cab! ENFO is included as part of the standard specification of all Kverneland sprayers.

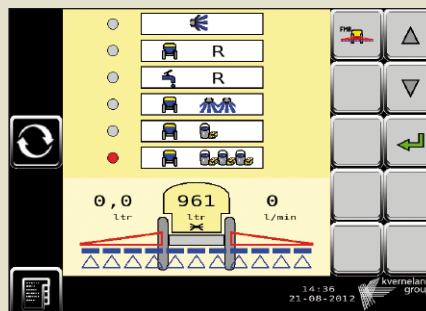

iXclean Pro screen Focus II/IsoMatch Tellus (coloured)

iXclean Pro

Advanced solutions come from iXclean Pro, with fully automatic, electric valve management on ISOBUS sprayers. It means all functions can be controlled from the cab. Switching between filling, agitation, spraying, diluting, priming, rinsing and tank cleaning, is extremely easy: just push the button!

In addition to auto filling, iXclean Pro offers also a fully automatic multi-step rinsing and cleaning program for the entire sprayer. Pushing one button a comprehensive cleaning process including all lines too starts, that takes just a few minutes and uses minimal amounts of clean water.

It is so thorough, that residue levels after automated cleaning, are below 1%. iXclean Pro for filling or cleaning: making every litre count!



Easy Operation

Filling, Agitating and Cleaning is Easy and Safe

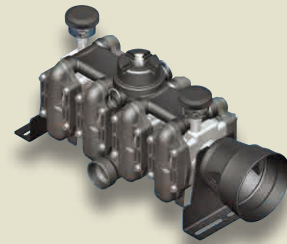

The new silent piston diaphragm pumps:

Pumps are available with capacities of 200, 250 and 400 l/min (2x200).

Continuous pressure of 15 bar, maximum 20 bar.

- Liquid fertiliser resistant
- Compact, small residual quantities of chemicals
- Linear steady state characteristics for precise regulation



Turbo agitation and power cleaning:

Chemicals are mixed safely by the chemical inductor, equipped with cleaning system and waterproof cover. The standard Ikarus S turbo agitation system with injector nozzles guarantees powerful agitation which you can activate during and after the filling process. After spraying, the aggressive tank cleaning nozzles are cleaning the inner-side of the tank. The float has a direct connection to the scale and optional to the level indicator for maximum safety and precision. Two generous-sized access points allow you to get inside the tank with a high pressure cleaner at the front - and backside if needed!

External washing (optional):

A cleaning kit with 15 meter hose and a brush, connected to the pressure side of the pump, allows pre-cleaning of the sprayer in the field, using clean water from the 300 litre clean water tank. There is always enough water available for cleaning due to the innovative water saving ENFO rinsing system.



FMC, Starguide IV Make Spraying Easy

Starguide IV: Automatic GPS section control and guidance by D-GPS

Those who have used it will never go back. Starguide IV will change your spraying days forever: spray around the headland and the Starguide IV will control the spray sections automatically as you cover the remainder of the field.

The Starguide IV enables you:

- Spraying in the dark
- Accurate spraying by full overlap control
- Increased operator comfort
- Cost savings by reduced overlap

In addition the Starguide IV also includes the following features:

- Easy to operate, intuitive 5.7" colour touch screen
- Integral light bar guidance system

- Field view with covered areas and overlap
- Single and double overlap in different colours
- GPS status warnings
- USB slot for data export in different formats
- RXA-30 antenna



Starguide IV is easy to operate: after spraying a field boundary the overlap and headland management are controlled for the rest of the field!



FlowMate Control FMC:

- Basic spray computer
- Extremely simple to operate
- Very compact by integration of all spraying and hydraulic functions
- Controlling the ENFO functions
- Integrated nozzle advice
- Memory for 25 different fields

Focus II One for All!

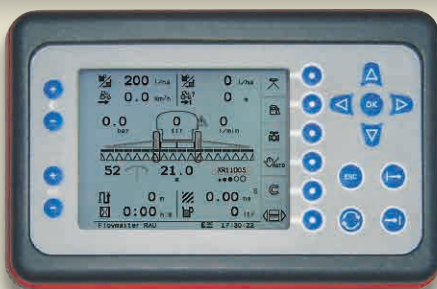

Switchbox

Operates spray and boom functions by intuitive layout for maximum comfort and short reaction times.

Focus II

Focus II is the professional Kverneland Group Terminal which fits to our sprayers, spreaders, seeders, precision seeders, loader wagons and balers for example.

- Large clear digital display
- All relevant parameters visible at a glance
- Memory for 40 different fields
- RS232 serial port to connect external sources



Serial port to connect external devices

The Next Generation Terminal!



The IsoMatch Tellus is the first Universal Terminal with the capability to view and operate 2 different ISOBUS interfaces at once. This allows direct control of 2 implements at the same time, use GEOcontrol or display a camera view, without switching screens.

- Two ISOBUS interface screens
- Large 12.1" colour touch screen
- Intuitive operation
- Basic DOC registration program to save operational information directly to USB
- Four USB slots for quick data exchange (e.g. ISO-XML field maps, PDF), wireless USB stick or USB to serial cable for additional sensors



IsoMatch Tellus is your powerful platform for precision farming applications and future growth.

- Built in PDF reader: store and read any PDF document such as operator manuals
- RS232 connection for GPS receivers or sensors



Switchbox

Operates spray and boom functions by intuitive layout for maximum comfort and short reaction times.



- Internet connection via a wireless USB stick or router
- Integrated web browser

IsoMatch GEOcontrol Brings Clear Benefits

IsoMatch GEOcontrol is an additional software application within the IsoMatch Tellus that helps you to control all ISOBUS compatible Kverneland Group machines such as sprayers, spreaders and seeders! Combined with a GPS receiver it fulfils the future needs in terms of easy, smart and efficient farming. Easy operation and driver comfort due to the automatic implement control. You can stay focused on driving, while IsoMatch GEOcontrol lightens the workload. Reduced overlap and redundant tracks results in increased quality of work and efficiency by cost savings in time, fuel, fertiliser, pesticides and seeds.

Section control

Automatic switching on and off implement sections on headlands, boundaries and already covered areas to minimise overlap.

Variable rate control

Automatically adjusts the implement application rate based on input from the field prescription or crop sensors.

Documentation

Saves all operational job data and field maps for exchange via USB to farm management information systems.

Manual guidance

- Advised driving position using guidance lines (straight, curved or combined) in the field and on headlands
- Extendable using the optional IsoMatch InLine light bar, to place guidance in line of sight
- Smart boundary recording: independent from the working width, even without any implement corrected
- Boundary shrinking: create new inner boundaries by setting the desired width of the headland
- Manual guidance for all operations, includes non-electric or non-ISOBUS implements. e.g. cultivators, mowers, tedders etc.
- Headland control: create headland boundary and headland guidance lines.



ISOMATCH GEOcontrol

- Easy and comfort of operation, due to not having to manually switch on or off sections or change the application rate. You can focus 100% on the driving in the field.
- More efficient work and avoiding overlap leads to cost savings of 5-10% on e.g. fertiliser, pesticides and seed. Better growing conditions and the increased yield.
- With IsoMatch GEOcontrol, working at night time becomes very easy. IsoMatch GEOcontrol reduces the workload considerably.

Boom Guide

Make Your Life Easy



Maintain your boom height!

ISO Boom Guide is our automatic boom height control system that helps you to maintain your chosen spraying height. Ultrasonic sensors control the sprayer's hydraulics to guide the boom over the crop canopy or soil surface. This unique sensor technology provides excellent guidance in many different and challenging field conditions, making it easier for the operator to stay focussed on spraying.

Boom Guide Comfort

The two ultrasonic sensors on the boom can control the spray height via the central slope correction and boom lift functions. This cost-effective system is suited to gentle slopes, uneven crop conditions and lower driving speeds.

Boom Guide Pro

This advanced system uses three ultrasonic sensors to control left- and right-hand boom sections independently for the ultimate guidance in the most challenging field conditions. It can deliver positive and negative lateral movement on each side of the boom to follow the contours in every condition!

Advantages of Boom Guide:

- Less drift: more constant and correct nozzle height
- Increased capacity: allows faster spraying speeds, also in the dark
- Driver comfort: less fatigue with easier focus on spraying
- Integrated ErgoDrive functionality: automatic lifting and lowering on headland turns
- Crop and Soil mode selection: closely follow the top of a closed canopy or of follow the soil surface in an uneven, open canopy or row crop situation
- Safe transport: ultrasonic sensor automatically fold with boom in its transport position
- ISOBUS compatible: easy plug and play operation with ISOBUS compatible (tractor) terminals



Joystick:

Joystick option for relaxed spraying:

- In combination with IsoMatch Tellus (not in combination with FMC or Focus II)
- Eight buttons at three levels allow to control 24 functions

Boom Guide Comfort

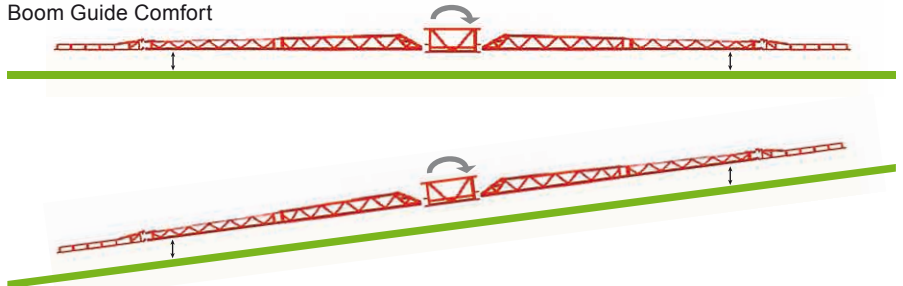

Boom Guide Pro

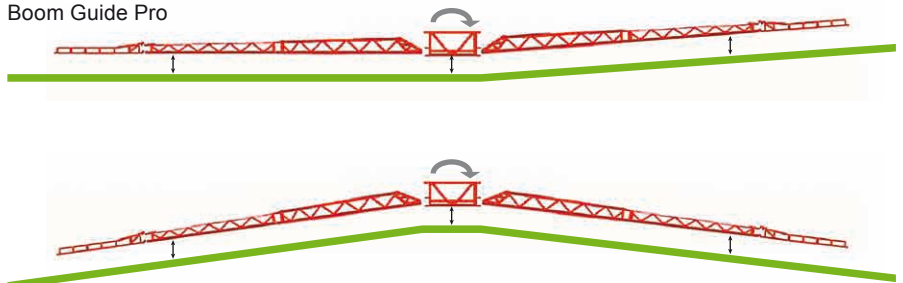

We Care about Your Crop!

Environmental FOCUS: ENFO priming and rinsing system is standard on all our spray computers

This smart technology optimises filling and cleaning of the spray lines. Accurate application, no waste of chemicals and saving water are the benefits for you and your environment.



Automatic Priming of spray lines: before spraying starts the spray lines are filled with chemicals exactly up to the nozzle by automatic section shut off. This means no waste of chemicals and accurate application from the start of spraying.

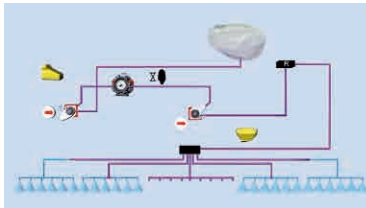

Automatic Rinsing of spray lines: after finishing or interruption, pesticides are automatically flushed out of the spray lines. This means using up to the last litre of mixture and rinsing the spray lines with a minimum of clean water consumption.

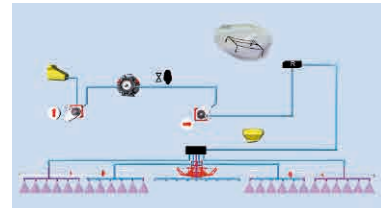

Sprayer Test Hall for Top Quality!



A highly qualified team of sprayer specialists tests every Ikarus S, and of course all other sprayers leaving the factory, in our own test hall to meet the latest environmental regulations. Our testers are certified for all of the following test procedures.



NSTS: National Sprayer Testing Scheme is the relevant authority in UK for sprayer homologation.



JKI: Official homologation for Germany, delivered by the Federal Biological Research Centre of Germany, now JKI Institute.



ENTAM: Homologation is in process. ENTAM is the European Network for

Testing Agricultural Machines. JKI of Germany and Cemagref of France are among others, official members of ENTAM.



SKL: Official homologation for Benelux, delivered by the SKL foundation for agricultural machinery in Wageningen.



NY: Official homologation for Norway, delivered by the Norwegian Food and Safety Authority.

iM FARMING

smart efficient easy **FARMING**



iM FARMING makes mechanical work smarter, more efficient and simpler. The use of ISOBUS technology makes machinery easier to connect, operate, control and monitor.

Maximum return from your investments, that is the core of Kverneland Group's iM FARMING solutions. iM FARMING describes and presents our offering on ISOBUS machines and solutions for electronic steering of implements. All aimed at giving an insight into the benefits and efficiency of our extensive offering, adapted to your requirements. That is what you can expect from Kverneland Group. Now and in the future. Intended to make life easier for farmers.

► Precision Spraying

Do you also want to spray a less as possible, at the right moment, at the right spot? That's why we have developed IsoMatch GEOcontrol. This smart and modern technology prevents waste of expensive chemicals and ensures perfect alignment on the headlands and in the triangles. Overlap is a thing of the past, which not only saves on crop protection agents, it also ensures a more equal crop yield and quality. Each plant receives exactly the same amount of crop protection.

► ISOBUS compatible

For even more operator comfort we have some other features available on our sprayer range. Boom Guide is an ultrasonic boom height control system operating the boom lift, slope correction and independent slope correction cylinders. iXclean Pro is our full electrical valve management system were all the functions can be controlled from the operators seat.

- 100% ISOBUS compatible
- Minimise overlap
- Parcel registration and data storage
- Up to 10% saving on pesticides
- Automatic switching ON/OFF through IsoMatch GEOcontrol



iM Ready
ISOBUS THAT'S WHAT I CALL SMART WORKING

iM inControl
ONE TERMINAL TO CONTROL ALL OF MY ISOBUS MACHINES

iM Global
WITH GPS IT'S SIMPLE AND MORE EFFICIENT

iM Intelligent
EASY, I JUST USE INTELLIGENT MACHINERY

IsoMatch GEOcontrol and SPRAYERcontrol

Would you like to have some clear benefits? You just have to buy the IsoMatch Tellus Terminal, a license and one of our ISOBUS compatible sprayers. Save 5% to 10% on your spraying costs and control and optimize your spraying process with IsoMatch GEOcontrol. Working at night? No worries, be at the forefront of environmental constraints. It is now possible with our applications!



iXtrack



iXter



Ikarus S



IsoMatch InLine



Manual guidance



Section control



Variable rate control



Documentation

► IsoMatch GEOcontrol

Once you have an IsoMatch Tellus Terminal you can simply unlock the IsoMatch GEOcontrol application (after you have purchased a license key) and you get access to all precision farming applications: automatic switching on and off implement sections, variable rate control, manual guidance and easy exchange of data between the IsoMatch Tellus and your PC. To get familiar and convince yourself about the customer benefits of IsoMatch GEOcontrol you are entitled to 10 hours free of use of the application, before purchasing a license. No doubt for us, you will quickly become an enthusiastic follower of this new technology!



IsoMatch Global



IsoMatch Eye

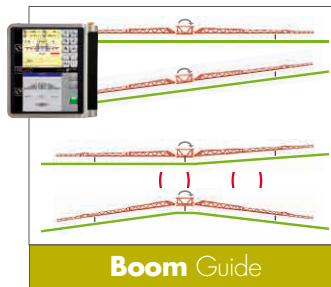

Boom Guide



iXclean Pro



HSS Boom

The Professional Side Folding Boom



Boom features:

- Professional hose guide and a cover for the valves
- Different hydraulic packages available
- Balancing system adjustable for flatland or hilly conditions
- Three-Part-Compact-Side-Folding spray booms (27/28/30m)

Safety tip-end: Simple and reliable, stable during spraying.

All HSS booms have a transport width of 2.50m and the overall height is below 4m. Even the 30m version fits in these transport dimensions. Narrow roads, hedges and trees do not cause trouble. Peace of mind and safety for the driver are ensured.





Hydraulic cylinders folded in at work for maximum strength. Mechanical locking by smart mechanism for total rigidity. All parts can be adjusted for optimal performance during the whole lifetime of the boom.

HSS boom (m)	Sections	Section deviation
18	5	6-9-6-9-6
18	7	6-5-5-4-5-5-6
20	5	8-8-8-8-8
20	7	5-6-6-6-6-6-5
21	5	9-8-8-8-9
21	7	6-6-6-6-6-6-6
24	7	6-6-9-6-9-6-6
24	9	4-4-4-9-6-9-4-4-4
27	7	6-9-9-6-9-9-6
27	9	6-6-6-6-6-6-6-6-6
28	7	7-9-9-6-9-9-7
28	9	7-6-6-6-6-6-6-6-7
30	9	6-3-9-9-6-9-9-3-6

Spraying width for different folding principles			
HSS boom (m)	# of sections	Symmetric folding (m)	Asymmetric folding (m)
18	5	12	15
20	5/7	12	16
21	5/7	12	16.5
24	7/9	12	18
27	7	21-12	24
27	9	21-9	24
28	7	21-12	24,5
28	9	21-9	24,5
30	9	21-12	25,5



Manual or electric border nozzles are available.

HC Boom

Multiple Folding Vertical Booms for All Circumstances



The HC boom range is tried and tested. Extremely strong and reliable

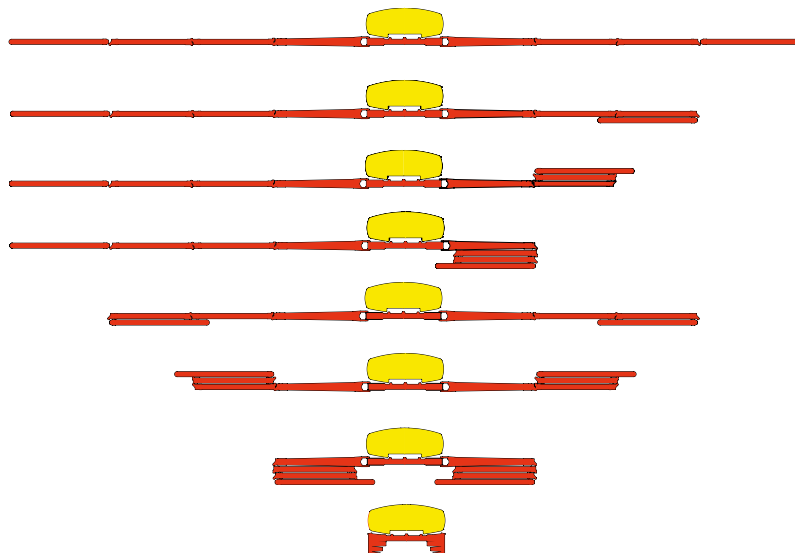
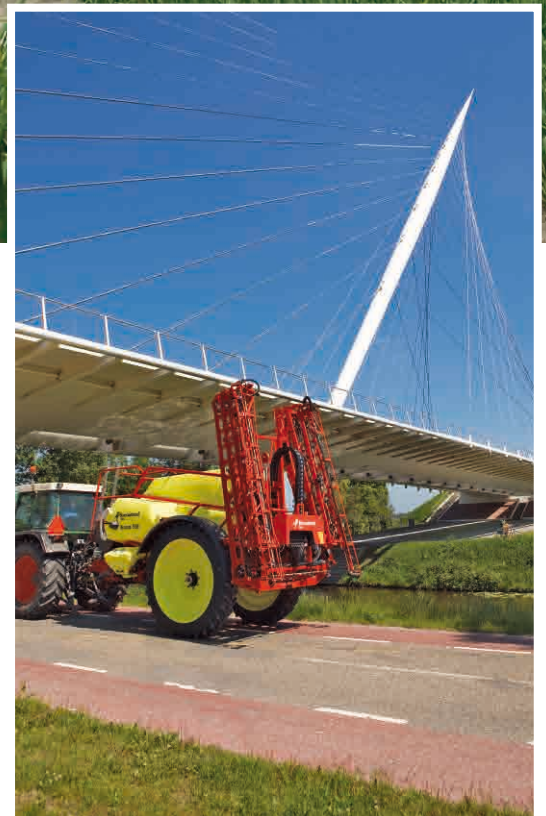

Multiple folding possibilities:
Symmetrical folding, asymmetric and one side spraying is possible.

Safe on the road:
All HC booms have a transport width of 2.5m and the height is below 4m.





The boom has been designed for 100% integration of spray lines and nozzles, for light weight and maximum strength.

Swing compensation:
A stable pattern at high speed.

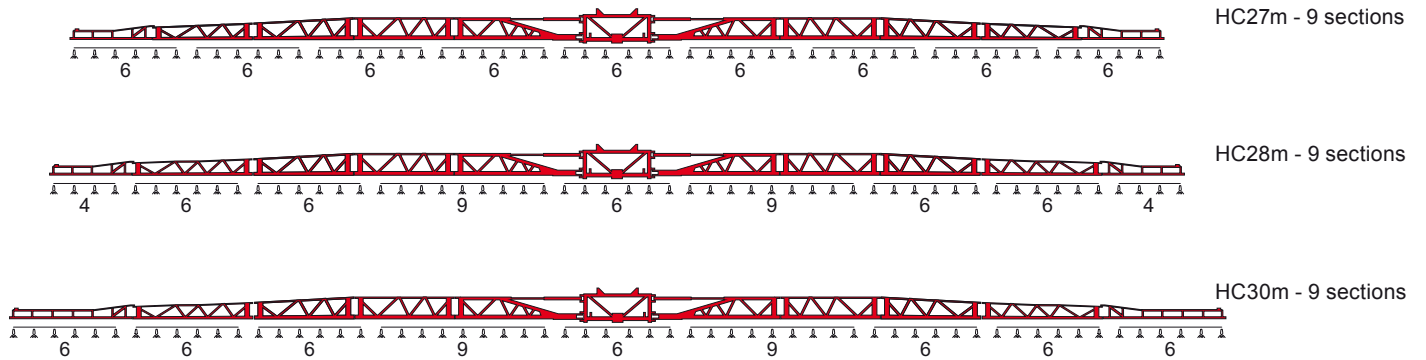

HC boom (m)	Sections	Section deviation	HC boom (m)	Sections	Section deviation
18	5	6-9-6-9-6	21	9	5-4-4-6-4-6-4-4-5
18	7	5-5-6-4-6-5-5	24	7	6-6-9-6-9-6-6
20	5	8-8-8-8-8	24	9	6-5-5-6-4-6-5-5-6
20	7	5-6-6-6-6-6-5	27	7	6-9-9-6-9-9-6
20	7	4-4-8-8-8-4-4	27	9	6-6-6-6-6-6-6-6-6
20	9	4-4-4-6-4-6-4-4-4	28	7	8-8-8-8-8-8-8
21	5	9-8-8-8-9	28	9	4-6-6-9-6-9-6-6-4
21	7	6-6-6-6-6-6-6	28	9	7-6-6-6-6-6-6-6-7
21	7	7-7-5-4-5-7-7	30	9	6-6-6-8-6-8-6-6-6

Kverneland Rau Ikarus S

Technical Specifications

Ikarus S	S28	S38
1. Tank size		
Nominal tank capacity (l)	2800	3800
Maximum main tank capacity (l)	3010	4000
Clean water tank with level indicator (l)	300	300
Hand wash tank (l)	20	20
2. Empty weight (total machine incl. boom)		
... with HSS 18m	2865kg	3055kg
... with HSS 20m	2910kg	3100kg
... with HSS 21m	2920kg	3110kg
... with HSS 24m	2960kg	3150kg
... with HSS 27m	3030kg	3220kg
... with HSS 28m	3040kg	3230kg
... with HSS 30m	3070kg	3260kg
... with HC 18m	3090kg	3280kg
... with HC 20m	3140kg	3330kg
... with HC 21m	3160kg	3350kg
... with HC 24m	3190kg	3380kg
... with HC 27m	3340kg	3530kg
... with HC 28m	3370kg	3562kg
... with HC 30m	3380kg	3570kg
3. Measurements		
Width (total machine incl. boom)	HSS 18-30m = 2.57m - HC 18-30m = 2.55m	
Height (total machine incl. boom)	HSS 18-30m = 3.98m - HC 18-30m = 3.98m	
Length (total machine incl. boom)	HSS18-21/27-28-30m = 5.66m - HSS24m = 6.02m - HC18m = 5.55m - HC20m = 5.70m - HC21m = 5.75m - HC24m = 5.80m - HC27-30m = 6m	
4. Drawbar		
Hitch or Top linkage fixed		▲ ¹
Hitch or Top linkage with auto steering (oil circuit needed)		▲ ²
Weight set for hitch or top linkage (HC boom only)		▲ ¹
5. Pulling eye		
Pulling eye Ø 40mm		▲ ¹
Pulling eye Ø 50mm		▲ ²
Ball coupling Ø 80mm		▲ ³
6. Wheel axle		
Fixed axle 1.50 - 1.80m without brake		▲ ¹
Fixed axle 1.50 - 1.80m with brake (up to 25km/h)		▲ ²
Sliding axle 1.50 - 2.25m with brake (up to 40km/h)		▲ ³
Sliding axle 1.50 - 2.25m with suspension and brake (up to 40km/h)		▲ ⁴
Hydraulic or air brake		●
7. Pumps		
Piston-diaphragm pump 200/250/400 l/min		▲ ¹
8. Electronics		
8.1 Basic spray computer		
FMC 5, 7 or 9 sections, 2-way valves, for pre select hydraulics (incl. FMC control box)		▲ ¹
FMC 5, 7 or 9 sections, 2-way valves, for oil circuit hydraulics (incl. FMC control box)		▲ ²
8.2 ISOBUS electronics		
FMA 5, 7 or 9 sections, 2-way valves, for oil circuit hydraulics (excl. control box)		▲ ³
8.2.1 Controls for ISOBUS electronics		
Switch box		▲ ¹
Focus II and Switch box		▲ ²
ITH (connection cable tractor side)		●
8.2.2 ISOBUS controls for ISOBUS electronics		
Switch box		▲ ¹
IsoMatch Tellus and Switch box		▲ ²
Joystick for IsoMatch Tellus		●
9. Other basics		
Wide angle PTO shaft 6 splines, manual parking jack, high pressure agitation system		standard
10. Options (factory fitted)		
Electrical level indicator		●
iXclean Comfort (incl. electrical level indicator)		●
iXclean Pro (incl. electrical level indicator)		●
Quick filling (not in combination with iXclean Comfort)		●
Boom Guide Comfort or Pro (only possible in combination with FMA electronics and IsoMatch Tellus)		●
11. Accessories (also loose available)		
Starguide IV		■
Chemical inductor		■
Mud guards (400/550/700 mm)		■
Hydrant filling		■
Suction hose 3"		■
Manual or electric border/verge nozzle		■
Outside cleaning set		■
Clean cloth locker		■
Urea sieve		■
Pump out connection		■
Boom lights and rotating beacon for HSS boom		■

▲¹ - ▲² - ▲³ = one of these choices must be selected ● = option (factory fitted), free to select ■ = Accessory, loose available



The steel parts of our sprayers are protected by a Duracoat powder paint coating. The result is a sealed extremely hard wearing and attractive finish.

Booms	HSS	HC
1. Basic boom functionality		
Working width	18 / 20 / 21 / 24 / 27 / 28 / 30m	18 / 20 / 21 / 24 / 27 / 28 / 30m
Material	Steel	Steel
Folding principle	(compact horizontal folding)	vertical folding
2. Spray sections		
Standard	5 / 5 / 5 / 7 / 7 / 7 / 9	5 / 7 / 7 / 7 / 9 / 9 / 9
Alternative 1 (two sections more than standard)	7 / 7 / 7 / 9 / 9 / 9 / 9	7 / 9 / 9 / 9 / - / - / -
Alternative 2 (two sections less than standard)	- / - / - / - / - / - / -	- / 5 / 5 / - / 7 / 7 / -
3. Spray jets		
Monojet	▲ ¹	▲ ¹
Trijet	▲ ²	▲ ²
Pentajet	▲ ³	▲ ³ only for HC 27-30m
4. Transport height		
Transport height in average (dependent on wheels)	3.70m	3.90m
5. Boom hydraulics		
Hydro-package HSS 18-24 Basic 1 contains pre-select for: -symmetric boom reduction -slope correction *1DA tractor valve for highlift and 1DA tractor valve for boom functions needed	▲ ¹ Requires: 3 valves hydraulic block	
Hydro-package HSS 18-24 Comfort 1 contains oil circuit for: -lift -symmetric boom reduction -slope correction *1DA tractor valve needed	▲ ² Requires: 5 valves hydraulic block	
Hydro-package HSS 18-24 Comfort 2 contains oil circuit for: -lift -symmetric and asymmetric boom reduction -hydraulic locking -slope correction *1DA tractor valve needed	▲ ³ Requires: 6 valves hydraulic block	
Hydro-package HSS 18-24 Comfort 3 contains oil circuit for: -lift -symmetric and asymmetric boom reduction -hydraulic locking -slope corrections -independent slope correction *1DA tractor valve needed	▲ ⁴ Requires: 8 valves hydraulic block	
Hydro-package HSS 27-30 Basic 1 contains pre-select for: -symmetric boom reduction (1st + 2nd + tipend) -slope correction *1SA tractor valve for highlift and 1DA tractor valve for boom functions needed	▲ ¹ Requires: 5 valves hydraulic block	
Hydro-package HSS 27-30 Comfort 1 contains oil circuit for: -lift -symmetric boom reduction (1st + 2nd + tipend) -slope correction *1DA tractor valve need	▲ ² Requires: 5 valves hydraulic block	
Hydro-package HSS 27-30 Comfort 2 contains oil circuit for: -lift -symmetric boom reduction -asymmetric boom reduction (tipends only) -hydraulic locking -slope correction *1DA tractor valve need	▲ ³ Requires: 8 valves hydraulic block	
Hydro-package HSS 27-30 Comfort 3 contains oil circuit for: -lift -symmetric boom reduction -asymmetric boom reduction (tipends only) -hydraulic locking -slope correction -independent slope correction *1DA tractor valve need	▲ ⁴ Requires: 10 valves hydraulic block	
Hydro-package HC 18-30 Comfort 2 contains oil circuit for: -lift -slope correction -independent slope correction -hydraulic locking -asymmetric boom reduction (left & right) *1DA tractor valve need		▲ ¹ Requires: 8 valves hydraulic block

▲¹ - ▲^{...} = one of these choices must be selected ● = option (factory fitted), free to select ■ = Accessory, loose available

Information provided in this brochure is made for general information purposes only and for worldwide circulation. Inaccuracies, errors or omissions may occur and the information may thus not constitute basis for any legal claim against Kverneland Group. Availability of models, specifications and optional equipment may differ from country to country. Please consult your local dealer. Kverneland Group reserves the right at any time to make changes to the design or specifications shown or described, to add or remove features, without any notice or obligations. Safety devices may have been removed from the machines for illustration purposes only, in order to better present functions of the machines. To avoid risk of injury, safety devices must never be removed. If removal of safety devices is necessary, e.g. for maintenance purposes, please contact proper assistance or supervision of a technical assistant.

© Kverneland Group Nieuw-Vennep BV



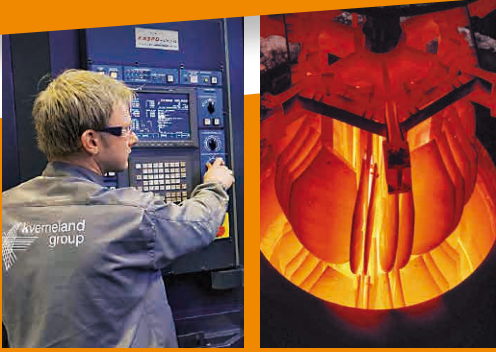
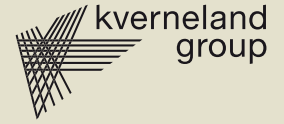

Kverneland Group

Kverneland Group is a leading international company developing, producing and distributing agricultural machinery and services.

Strong focus on innovation allows us to provide a unique and broad product range with high quality. Kverneland Group offers an extensive package aimed at the professional farming community, covering the areas of soil preparation, seeding, forage and bale equipment, spreading, spraying and electronic solutions for agricultural tractors and machinery.



Original Spare Parts

Kverneland Group spare parts are designed to give reliable, safe and optimal machinery performance - whilst ensuring a low cost life-cycle. High quality standards are achieved by using innovative production methods and patented processes in all our production sites.

Kverneland Group has a very professional network of partners to support you with service, technical knowledge and genuine parts. To assist our partners, we provide high quality spare parts and an efficient spare parts distribution worldwide.



 **Watch us on YouTube**
www.youtube.com/kvernelandgrp

Kverneland Group
N-4355 Kverneland
Norway
Phone: + 47 51 42 94 00
Fax: + 47 51 42 94 01
contact@kvernelandgroup.com

 **Like us on facebook**
www.facebook.com/KvernelandGroup
www.facebook.com/iMFarming

Kverneland Group Canada Inc.
1200, rue Rocheleau
Drummondville (Québec), J2C 5Y3, Canada
Phone: +1 819 477 2055
kvcanada@kvernelandgroup.com

 **Follow us on Twitter**
[#KvernelandGroup](https://twitter.com/KvernelandGroup)
[#iM_Farming](https://twitter.com/iM_Farming)

www.kverneland.com

