

**Kverneland Taarup
8000 Tedder Series**



Efficient and Gentle Spreading



The Right Tedder for Every Farm Size

Kverneland Taarup's tedder range is suitable for all sizes of operations. With working-widths ranging from 4.6m to 13.3m and with mounted and trailed versions, the Kverneland Taarup 8000 series offers a tedder to suit all requirements and farm sizes.





CompactLine

The CompactLine tedders feature a maintenance friendly gearbox with only one grease nipple. The gearbox is flanged to the frame that have no supporting function, and therefore is not subjected to any strain.

ProLine

The ProLine tedders feature a uniquely designed self-contained rotor gearbox. Wear on an enclosed and oil-immersed gearbox is reduced to a minimum. The main crown wheel in each gearbox is mounted directly to the casing, by means of a large diameter radial bearing. They have no supporting function, and therefore are not subjected to any strain.

The advantages

- Working widths from 4.6m right up to 13.3m.
- Low maintenance gearbox on the CompactLine range for smaller and medium sized farms.
- Maintenance-free gearbox on the ProLine range for the toughest conditions.
- Largely dimensioned oscillation dampers for excellent running characteristics and working result.
- An exceptionally solid design of the chassis which allows the tedder to withstand the most severe loads.
- 10mm strong tines with 80mm coil diameter for unsurpassed flexibility.
- XXL-rotor plate with a diameter of no less than 500mm for excellent fixation of the tine arms.

With models ranging from 4.6m to 13.3m, Kverneland Taarup's range of tedders is designed to meet the requirements of any tedding operation.

Rotary Tedders Straight from the Inventor...



50 Years of Experience



In 1961 a completely new concept in the hay making was introduced with the very first rotary tedder. It was invented by Fahr in Gottmadingen (Germany), today known as the Kverneland Group Gottmadingen Hay tools competence centre. The very first rotary tedder - the KH series was available with either 2, 4 or 6 rotors and truly revolutionized the process of hay making. It was instantly recognized as a very efficient and accurate solution for turning and drying the crop.

Since the introduction of the first tedder more than 250.000 tedders have been sold out of Gottmadingen, making the Kverneland brand one of the most successful tedder worldwide. Today the Kverneland 8000 tedder range is benefitting from more than 50 years of experience, offering the most complete and attractive tedder range in the market.

The 8000 series Advantages

- Working widths from 4.6m right up to 13.3m
- Low maintenance gearbox on the CompactLine range for smaller and medium sized farms
- Maintenance-free gearbox on the ProLine range for the toughest conditions
- Generously dimensioned oscillation dampers for excellent running characteristics and working result
- An exceptionally solid design of the chassis, which allows the tedder to withstand the most severe loads
- 10mm strong tines with 80mm coil diameter on ProLine, offering unsurpassed flexibility
- XXL-rotor plate with a diameter of no less than 500mm for excellent fixation of the tine arms



The very first rotary tedder KH4 was introduced in 1961.

ProLine

Solid Design - Maintenance Free Operation

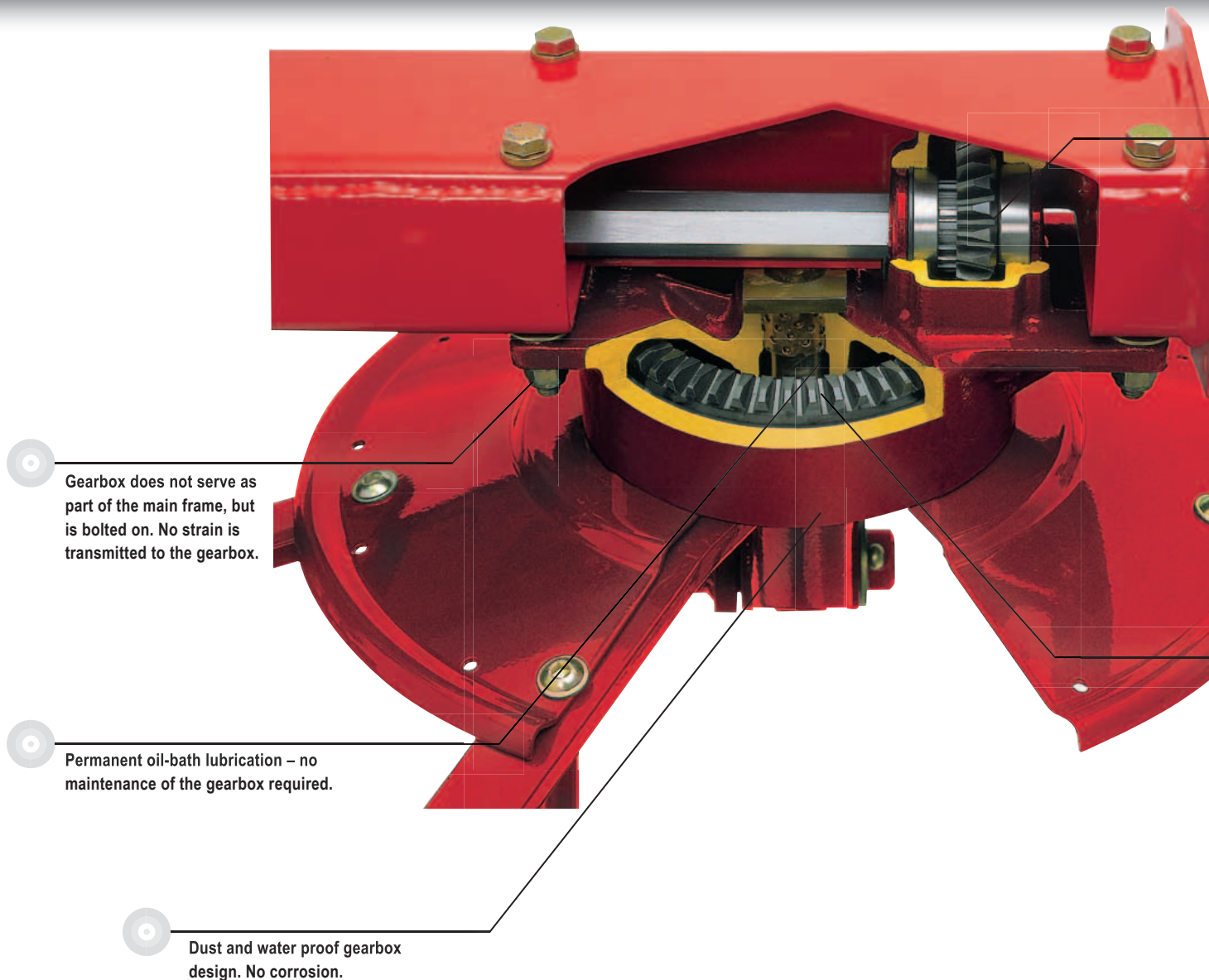

A Strong Reliable Heart

Kverneland ProLine tedders feature a uniquely designed self-contained rotor gearbox. The ProLine gearbox requires no maintenance, and is situated in an enclosed oil-bath, set up to ensure permanent lubrication. No service or maintenance of the ProLine gearbox is needed.

The gearboxes do not serve as part of the frame, but are bolted onto the fully welded main frame. This ensures that no load and strain from frame or tine arm vibrations will be transmitted by the gearbox, adding to significant longer lifetime.

The ProLine gearboxes features reliable crown and pinion drives positioned in one housing. The main crown wheel in each gearbox is mounted directly to the casing by means of double bearing. The double bearings on both sides of the hexagonal drive shaft keeps the shaft securely in place, even when operating in heavy duty wet crops.

Double bearing on both sides of the drive shaft for highest durability to withstand the most severe conditions.

Crown wheel and pinion positioned in one housing for very reliable drive.

Double universal joints give smooth and efficient transfer of power.

Box shaped mainframe with only one welding seam for maximum rigidity.

Greasable pivoting points with large diameter guarantee a very strong and reliable construction.

Heavy Duty Main Frame Design

The tedders are built around a rugged new box section main frame, made out of one piece of metal with only one welding seam – for maximum rigidity. The frame design is fully enclosed at the top edge for maximum strength – an exceptionally solid design, which allows the tedders to withstand the most severe loads.

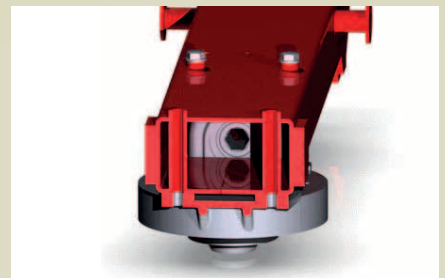

The large drive shafts and double U-joints give smooth, efficient transfer of power through the frame allowing each rotor to accurately follow field contours and rotate in all positions.



Greasable pivoting points are extremely wide and mounted in double bush bearings for maximum dependability.

Super-C Tines – Even Spread, Clean Job

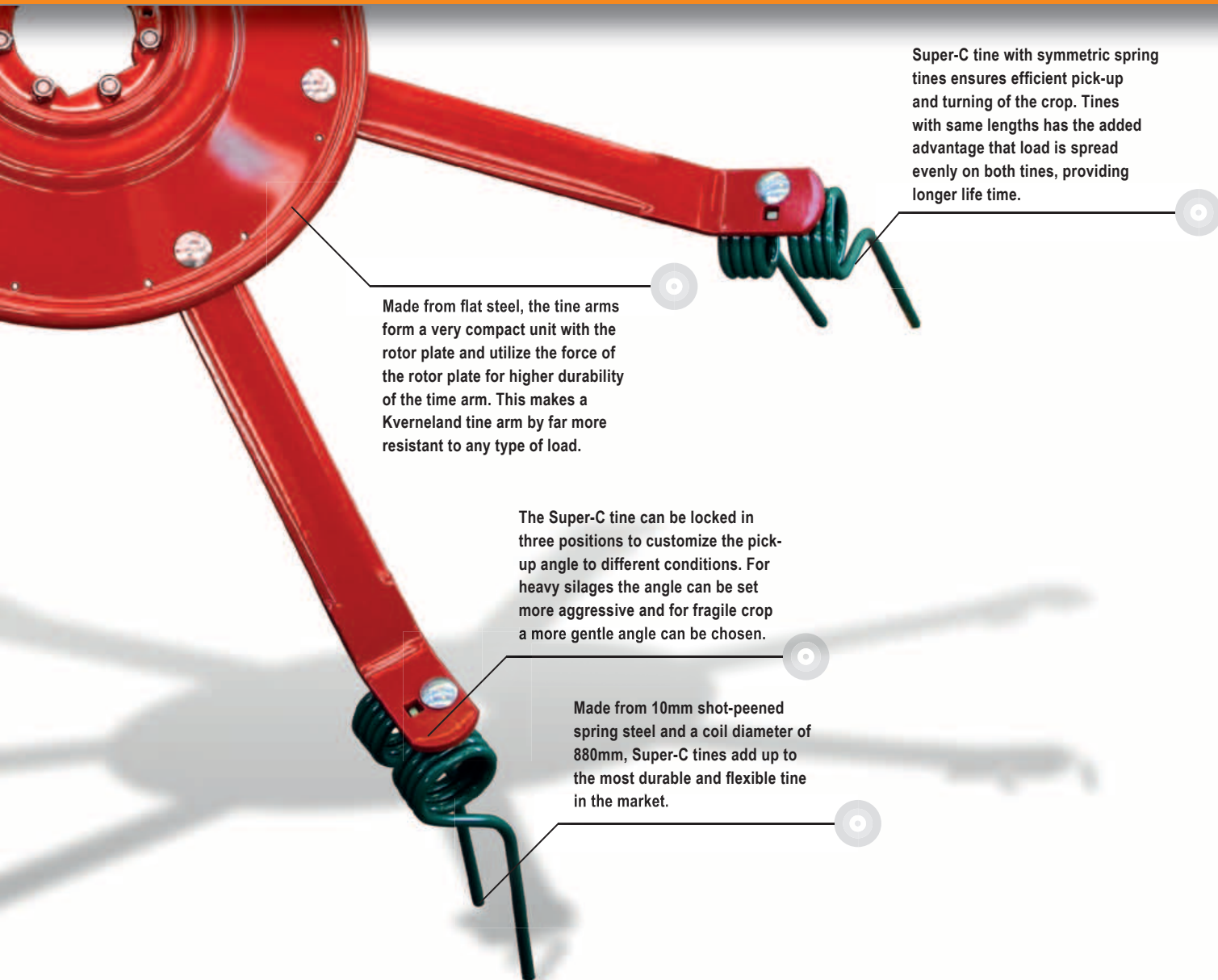

Super-C tine with symmetric spring tines ensures efficient pick-up and turning of the crop. Tines with same lengths has the added advantage that load is spread evenly on both tines, providing longer life time.

Made from flat steel, the tine arms form a very compact unit with the rotor plate and utilize the force of the rotor plate for higher durability of the time arm. This makes a Kverneland tine arm by far more resistant to any type of load.

The Super-C tine can be locked in three positions to customize the pick-up angle to different conditions. For heavy silages the angle can be set more aggressive and for fragile crop a more gentle angle can be chosen.

Made from 10mm shot-peened spring steel and a coil diameter of 880mm, Super-C tines add up to the most durable and flexible tine in the market.

Take the Lead in Beating the Weather

Kverneland tedders help you produce high quality crop, even under difficult weather circumstances. Ever changing weather conditions often leave a very tight time window to prepare the crop. When the weather proves to be flexible, it is vital that your gear and equipment is just as flexible.

The Kverneland tedders are the right tool to accomplish uniform and rapid drying action of the crop. The Kverneland Super-C tines, working with generous overlap thanks to the rotor design, always leave an airy and evenly spread crop, speeding up the drying process so you can chop or bale the crop in time. Kverneland tedders allow you to instantly react to unpredictable weather conditions.



Optional third wheel lead to even more accurate track following and better tedding action.

The Super-C Tine

In order to produce high quality silage or hay, the crop must be spread evenly across the field to facilitate a uniform drying process. In addition soil contamination is a no go. The symmetric Kverneland Super-C tines of identical length efficiently pick up the crop and turn it for a very efficient crop flow. The crop is spread evenly and thrown over a wide distance, to ensure that the wet crop is placed on top of dry crop.

Tines with same lengths has the added advantage that load is spread evenly on both tines, providing longer life time.

The Kverneland Super-C tines are made of 10mm shot-peened spring steel. Spring diameter coils have 20% larger diameters than conventional designs for added service life, even when tedding large quantities of crop.



Setting the Right Spreading Angle

Simple three-way adjustment of wheel height, allows the optimum spreading angle to be achieved according to crop conditions, helping you to produce high quality forage.



Setting the rotors to the right spreading angle will considerably improve the spreading action and speed up the drying process. Set a steep angle for aggressive conditioning effect or choose the more flat angle for more gentle treatment of dry or very fragile material.



ProLine tedders are fitted with 10mm shot-peened spring steel combined with a coil diameter of 80mm that adds up to the most durable and flexible tine in the market.



Generous overlap ensures that crop is spread evenly.

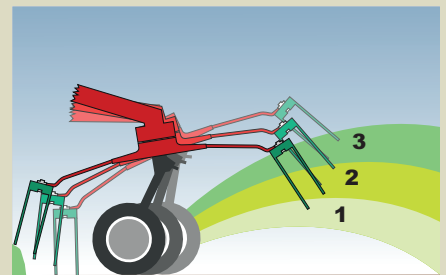

Easy adjustment of spreading angle via pin holes, not tools required.

Oscillation Dampers for Smooth and Even Crop Distribution



Vibration Dampers

The Kverneland oscillation dampers ensure excellent ground contour following and tedder flotation. The construction of the oscillation dampers results in a smooth and even distribution of the grass, due to the constant tine distance to the ground. The distant linkage point means that it offers excellent running characteristics compared to conventional oscillation dampers.

The fact that the linkage is positioned low on the headstock results in a more effective damping action during transport.

- Widely spaced mounting points
- no risk of 'hunting'
 - Excellent running characteristics
 - Low-positioned linkage on the head-stock for more effective damping action during transport
- No risk of the tedder running under the tractor on downhill work, excellent tedding at all times through constant tine spacing to the ground
 - Maximum stability in transport position
- no further lock of headstock required.

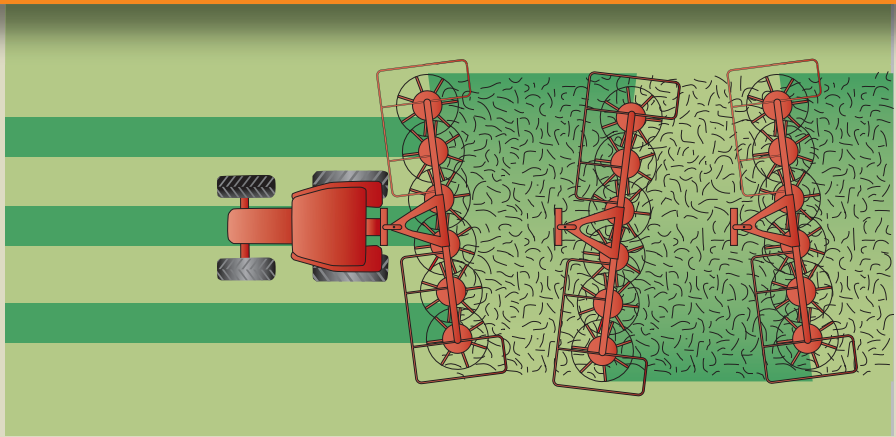

Conventional systems

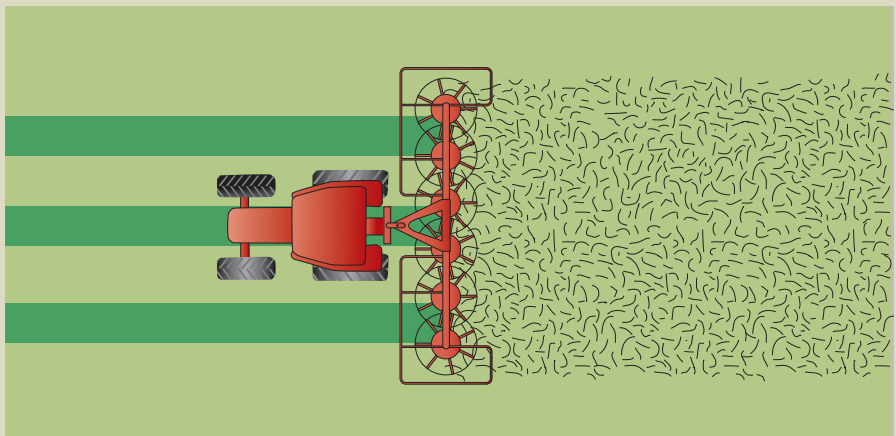

Kverneland Oscillation dampers



Compact and Robust Design



Kverneland Taarup 8460 with a working width of 6.05m.

Low maintenance

Kverneland Taarup offers 5 versions of compact tedders with low maintenance requirements and a working-width ranging from 4.6m to 8.05m. Maintenance friendly features include 500mm rotor plates and an easy-to-maintain gearbox. All tedders can be adjusted centrally, to move the machine to the desired position for border tedding.

Minimum Power Requirements

The strong but compact design of these tedders makes them the ideal solution, for farmers handling medium quantities of grass or hay. The tedders have been designed to work well with smaller tractors, especially the trailed Kverneland Taarup 8452 T.



Kverneland Taarup 8452 with 5.2m working width.



The angle for border tedding is set from the tractor cab.



As an option the tedders can be equipped with a third wheel, to improve the ground contour followings.



Despite its 8m working width, the Kverneland 8480 will fold to just under 3m, making it a very compact unit for transport



The two outer rotors are fitted with the new HexaLink finger clutch, a simple yet efficient drive system that permits these rotors to turn into a 180° position for transport.



All tedders fold hydraulically from working to transport position.

The Ideal Hay Making Tedders

Kverneland Taarup 8460 and 8480 come with a strong package of features, such as 2 vibration dampers, strong V-shaped central unit and central adjustment for border tedding. They offer considerable working width with their combination of 6/8 rotors and 6.05m/8.05m working width.

The very small rotors are especially designed for optimized performance while producing dry hay. The compact rotors,

in combination with a big overlap, ensure complete pick-up of the grass and equal distribution over the entire working width. Both tedders are fitted with a central adjustment device for setting the machine at the correct angle for border tedding.

This is set mechanically from the tractor cab and is done in very few seconds. Optionally hydraulic operation is available too.

Extreme, Reliable Performance



Minimum wear and maintenance is achieved on the ProLine series, due to the uniquely designed, fully oil-immersed gearbox.

Designed for long working days

Kverneland Taarup 8055, 8068 and 8076 are high-quality tedders with working widths ranging from 5.5-7.6m. All tedders are supplied with a pivoting 3-point headstock, ensuring very stable and strong performance.

The strong construction and oil-bath gearbox makes the machines reliable and efficient, and suitable for long working days. They are supplied with a transport carrier as an option, making it possible to operate the tedders in combination with low-horsepower tractors.

A high number of features as standard

Kverneland Taarup 8055, 8068 and 8076 are supplied with many standard features. Oscillation dampers ensure excellent running characteristics and even and smooth flotation. Central adjustment for border tedding ensures that no grass is lost because of ditches or fences.



Kverneland Taarup 8076 C with 7.6m working width.

Four rotor tedder with long working life

Kverneland Taarup 8055 is a reliable 4 rotor tedder that offers all the unique features of larger machines. It comes with a very strong construction and oil bath gearbox. With 7 tines per rotor, the tedder offers more tines than most comparable tedders. This means that Kverneland Taarup 8055 is a tedder that provides excellent working performance at higher working speeds.



Border tending is operated mechanically from the tractor cabin and is supplied as standard on all 3 machines. It only takes a few seconds to place the tedder in the right position.



Kverneland Taarup 8055, 8068 and 8076 are easily converted from transport to working position and fold hydraulically. Transport width is less than 3m.



The Kverneland Taarup 8076 can be supplied with a transport carrier, thus allowing operating the tedder in combination with low horse power tractors.

High Performance - Low Power Requirements



6 rotors, each with 7 tines ensure excellent working results.

Performance at High Speed

Kverneland Taarup 8583 T and 85111 T offer wide working widths of 8.3m and 11.0m respectively, but they are still ideal for lower horsepower tractors thanks to the trailed concept. They are fitted with the maintenance-free oil-immersed ProLine. Both tedders have low lift and input requirements. Their design minimises compaction and operating costs. Certainly a great advantage in times of escalating fuel prices.

Maintenance Reduced to a Minimum

The new 8583T and 85111T are extremely pleasant to work with. Maintenance requirements have been reduced to a minimum with the new ball bearings, with which the individual framework construction units are connected.

The ball bearings of the hinges are now life span lubricated. In combination with the ProLine gearbox, which is situated in an enclosed oil-bath ensuring constant lubrication, maintenance of the entire tedder is reduced to a minimum.

Easy Transport

Kverneland Taarup 8583 T and 85111 T are both easily converted from working into transport position. Wheels are fixed during transport, ensuring very smooth and stable running.

These trailed tedders offer all the comfort of a 3-point linkage machine and are easily converted from transport to work position, without leaving the tractor seat.

The rotor wheels have been upgraded to 18" to ensure even more stability during work and operation. Both models are approved for 40km/h.



Kverneland Taarup 85111 T offers both pin-hitch or linkage drawbar attachment.



During transport the tedder simply follows easily and smoothly behind the tractor.

Pin-Hitch or Drawbar Attachment

85111 T and 8583 T offer the unique option of either pin-hitch or drawbar attachment. You simply refit a pin for continental pin-hitch attachment or linkage drawbar attachment. Continental pin-hitch attachment will not put the PTO-shaft at risk, and makes for very easy attachment without difficulties.



The working height of Kverneland Taarup 8583 T is set mechanically. This ensures that the machine is easily adjusted to the ground conditions in question.



In standard position the wheels are pivoting, but they can be easily fixed for hilly conditions.

Setting a New Standard for Mounted Tedders!



The 8090 models offer an extensive 9m tedding width with supreme flotation, due to the oscillation dampers fitted as standard.

High capacity

Kverneland Taarup 8090 is setting new standards for mounted tedders. With 9m working width it offers efficient and gentle spreading. The high performance of the machine, means it is possible to achieve cost-efficient tedding.

Reliable construction

Oscillation dampers are supplied as standard features on Kverneland Taarup 8090, and ensure excellent running characteristics and even and smooth flotation. Kverneland Taarup 8090 has a pivoting 3-point headstock, ensuring very stable and strong working performance.

The strong construction of the central unit (V-shaped frame), the oil-bath gearbox and the extra large tines make it very reliable and durable.



For border tedding the machine is swung at an angle to ensure no loss of grass, and all operations are carried out from the tractor cab.



The Kverneland Taarup 8090 folds hydraulically for transport position without need of leaving the tractor seat.



Despite a working width of 9m the Kverneland Taarup 8090 is very compact in transport, with a width of less than 3m.



The 8090 C is the optimal solution for use with a low power tractor.

Kverneland Taarup 8090 C with transport running gear

The standard specification includes a hydraulic border tedding system for your convenience. In road transport, tedder weight rests on the running gear, rather than on the tractor's rear axle. The optimized oil-immersed driveline makes for a low input requirement, so you can easily

use a small tractor and still work a wide working width - the ideal solution that saves fuel and running costs. The running gear folds hydraulically and towards the centre of gravity for good balance. All folding is fully automatic, to eliminate the risk of operator error. One double-acting spool is required to operate the tedder.



11-14m Working Power



8 rotors, each with 7 tines ensure excellent working results.

It's all about performance!

Kverneland Taarup 80110 C offers high performance for farmers and contractors looking for first-class tedding performance. All you need is a single and a double acting valve to control the whole machine. 8 rotors each with 7 tine arms can handle 4 swaths from a 3m mower in a gentle and effective way.

Easy handling

Kverneland Taarup 80110 C is very easy to use. All operations are run hydraulically, and can be controlled from the tractor cab. The tedder comes with a hydraulic adjustment for border tedding, to prevent loss of grass due to ditches or fences. Despite its size, the tedder is very easy to run. It is supplied with transport carrier as standard, making it possible to operate the machine in combination with low horsepower tractors.

Unique transport solution

Kverneland Taarup 80110 C and 85140 C offer a unique transport solution that improves total work of the tedder. In transport position the outer rotors are folded forward onto a carrier frame. In this way transport height for 80110 C and 85140 C is only 3.35m, and a transport width of less than 3m is achieved. The carrier frame allows the tedders to move forward quickly and easily when going from one field to another. This not only saves time but improves the total efficiency of the tedding process.



13.3m working width with easy handling and first-class performance.



For border tedding the right outer arm is moved at the correct angle, to avoid loss of grass.



The outer rotors are fixed during transport and there is no load on the carrier frame.



All operations are run hydraulically, including the unfolding process.

Kverneland Taarup 85140 C - Massive Output

10 Rotors, transport carrier and 13.3m working width characterises Kverneland Taarup 85140 C. This is a professional solution which combines wide working width with maximum stability, easy maintenance and excellent manoeuvrability.

85140 C - Characteristics in Short

- Strongest tine on the market with 10mm diameter and 80mm coil.
- 7 tine arms for optimal pick-up and distribution of material.
- Sturdy and largely dimensioned frame.
- Gear units flanged to the frame - no carrying function.
- 3-step tool free adjustment of rotor inclination for varying working conditions.

Minimum Maintenance

All vital parts are enclosed in a permanent oil bath for extreme durability and stability. The bearings offer a further innovation, with which the individual framework construction units are connected. The ball bearings are life span lubricated. This absolutely maintenance-free kind of storage guarantees maximum stability and life span.

Technical Specifications

Models	8446	8452	8452 T	8055	8460	8068	8076	8076 C	8480	8583 T	8090
Dimensions and Weights											
Working width* (m/feet)	4.60(15'1")	5.20(17'1")	5.20(17'1")	5.50(18'1")	6.05(19'10")	6.80(22'4")	7.60(24'1")	7.60(24'1")	8.05(26'4")	8.30(27'3")	9.00(29'6")
Width, working position (m/feet)	4.90(16'1")	5.40(17'9")	5.40(17'9")	5.80(19')	6.30(20'8")	7.13(23'5")	7.98(26'2")	7.98(26'2")	8.35(27'4")	8.63(28'4")	9.33(30'7")
Transport width (m/feet)	2.84(9'4")	2.89(9'6")	2.87(9'5")	2.90(9'6")	2.75(9')	2.98(9'9")	2.98(9'9")	2.98(9'9")	2.90(9'2")	2.90(9'9")	2.98(9'9")
Transport length (m/feet)	2.16(7'3")	2.12(7'3")	2.54(8'6")	2.30(7'7")	1.85(6'1")	2.17(7'3")	2.37(7'10")	3.80(12'6")	1.90(6'23")	5.60(18'4")	2.17(7'3")
Transport height (m/feet)	2.44(8')	2.64(8'8")	2.64(8'8")	2.80(9'2)	3.10(10'2")	3.58(11'9")	3.85(12'8")	3.85(12'8")	3.15(10'33")	1.20(3'11")	3.45(11'4")
Weight approx. (kg/lbs)	500(1102)	530(1170)	410(904)	640(1411)	670(1444)	855(1885)	890(1962)	1200(2645)	960(2116)	900(1984)	1100(2425)
Capacity theor. (ha/h)	3.7	4.2	4.2	4.4	4.8	5.4	6.1	6.1	6.4	6.6	7.2
Linkage											
Pivoting 3-point headstock	Cat. I+II	Cat. I+II	-	Cat. I+II	Cat. I+II	Cat. II	Cat. II	Cat. II	Cat. II	-	Cat. II
Tow bar / Hitch	-	-	•	-	-	-	-	-	-	•	-
Two point lower linkage	-	-	-	-	-	-	-	-	-	-	-
Oscillation dampers	•	•	-	-	-	-	-	-	•	-	-
- integr. locking device	-	-	-	•	•	•	•	•	•	-	•
Rotors/Tines/Safety Frames											
Number of rotors	4	4	4	4	6	6	6	6	8	6	8
Number of tine arms per rotor	6	6	6	7	5	6	7	7	5	7	6
Tine loss prevention equipm.	0	0	0	0	0	0	0	0	0	0	0
Spreading angle adjust. (3 pos.)	•	•	-	•	-	•	•	•	•	-	•
Mech. central wheel adjust.											
for border tedding	•	•	-	•	•	•	•	•	•	•	•
Same, hydraulic	0	0	-	-	0	0	0	0	0	0	0
Low maintenance gearbox	•	•	•	-	•	-	-	-	•	-	-
Oil-bath gearbox	-	-	-	•	-	•	•	•	-	•	•
Wheel/Axles											
Tyres	16x6.5-8	16x6.5-8	16x6.5-8	16x6.50-8	16x6.50-8	16x6.5-8	16x6.5-8	16x6.5-8	16x6.5-8	18x8.5-8	16x6.5-8
Tyres, central unit	-	-	-	-	-	-	-	18.5x8.5-8	-	-	18.5x8.5-8
Front gauge wheel	0	0	-	0	0	0	0	•	0	-	0
Anti-wrapping cones	•	•	•	•	•	•	•	•	0	•	•
Carrier frame	-	-	-	-	-	-	-	-	-	-	-
Tandem axles	0	0	-	0	-	0	0	-	0	-	-
Warning panels	0	0	0	0	0	0	0	-	0	-	-
-, with integr. lighting	0	0	0	0	0	0	0	•	0	•	•
*(DIN 11220)											
• = Standard 0 = Optional - = Not available											

Information provided in this brochure is made for general information purposes only and for worldwide circulation. Inaccuracies, errors or omissions may occur and the information may thus not constitute basis for any legal claim against Kverneland Group. Availability of models, specifications and optional equipment may differ from country to country. Please consult your local dealer. Kverneland Group reserves the right at any time to make changes to the design or specifications shown or described, to add or remove features, without any notice or obligations. Safety devices may have been removed from the machines for illustration purposes only, in order to better present functions of the machines. To avoid risk of injury, safety devices must never be removed. If removal of safety devices is necessary, e.g. for maintenance purposes, please contact proper assistance or supervision of a technical assistant. © Kverneland Group Kerteminde AS

8090 C	80110 C	85111 T	85140 C
9.00(29'6")	11.00(36'1")	11.00(36'1")	13.30(43'8")
9.33(30'7")	11.32(37'2")	11.32(37'2")	13.65(44'9")
3.80(12'6")	2.98(9'9")	2.98(9'9")	2.98(9'9")
2.17(11'10")	5.90(19'4")	7.25(23'11")	5.90(19'4")
3.75(11'4")	3.30(11')	1.25(4'1")	3.35(11')
1400(3087)	1620(3527)	1100(2400)	2300(5071)
7.2	8.8	8.8	11.2
Cat. II	-	-	Cat. II
-	-	•	-
-	•	-	•
-	-	-	-
-	-	-	-
8	8	8	10
6	7	7	7
0	0	0	0
•	•	-	•
•	-	-	-
•	•	-	•
-	-	-	-
•	•	•	•
16x6.5-8	16x6.5-8	18x8.5-8	16x6.5-8
18.5x8.5-8	18.5x8.5-8	-	18.5x8.5-8
•	-	-	-
•	•	•	•
10.0x75-15	10.0x75-15	-	10.0x75-15
-	-	-	-
-	-	-	-
•	•	•	•

The Right Tedder for Every Cutting Width



	1.60 / 1.80 m	2.00 / 2.10 m	2.40 m	2.80 m	3.00 m	3.20 / 3.30 m	4.00 m
Model 8446							
Model 8452 (T) Model 8452							
Model 8055							
Model 8460							
Model 8068							
Model 8076 Model 8076 C							
Model 8480							
Model 8583 T							
Model 8090 Model 8090 C							
Model 80110 C Model 85111 T							
Model 85140 C							

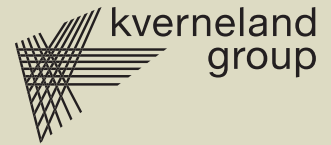

Kverneland Group

Kverneland Group is a leading international company developing, producing and distributing agricultural machinery and services.

Strong focus on innovation allows us to provide a unique and broad product range with high quality. Kverneland Group offers an extensive package aimed at the professional farming community, covering the areas of soil preparation, seeding, forage and bale equipment, spreading, spraying and electronic solutions for agricultural tractors and machinery.



Original Spare Parts

Kverneland Group spare parts are designed to give reliable, safe and optimal machinery performance - whilst ensuring a low cost life-cycle. High quality standards are achieved by using innovative production methods and patented processes in all our production sites.

Kverneland Group has a very professional network of partners to support you with service, technical knowledge and genuine parts. To assist our partners, we provide high quality spare parts and an efficient spare parts distribution worldwide.



 **Watch us on YouTube**
www.youtube.com/kvernelandgrp

 **Like us on facebook**
www.facebook.com/KvernelandGroup
www.facebook.com/iMFarming

 **Follow us on Twitter**
[@KvernelandGroup](https://twitter.com/KvernelandGroup)
[@iM_Farming](https://twitter.com/iM_Farming)

Kverneland Group UK Ltd.
Walkers Lane, Lea Green, St. Helens
Merseyside, WA9 4AF
Phone + 44 1744 8532 00

Kverneland Group Ireland Ltd.
Hebron Industrial Estate
Kilkenny, Ireland
Phone + 353 56 51597

Kverneland Group Canada Inc.
1200, rue Rocheleau
Drummondville (Quebec)
J2C 5Y3, Canada
Phone +1 819 477-2055, Fax +1 819 477 9062

www.kverneland.com

