

EARLY RISER 1200 SERIES PLANTER



# EARLY RISER<sup>®</sup>

1200 SERIES PLANTER







# EARLY RISER 1200 SERIES PLANTER

4 Models | 6–31 Rows | 7" × 7" Frame Size

EARLIER EMERGENCE. UNIFORM STANDS. PHOTOCOPY PLANTS.

1200 series Early Riser planters are designed with field-proven technology from the meter to the seed trench and have set the industry standard since 1981. Engineered to deliver accurate and more uniform seed placement, 1200 series Early Riser planters are reliable and productive in a range of conditions to help you get more done during optimal planting windows and produce higher yields.

## 1200 SERIES PLANTERS

Agronomic Design™	4
Uniform Emergence	5
Agronomic Drivers	6-7
First-to-Market Features	8-9
Early Riser Row Unit	10-11
Advanced Seed Meter (ASM)	12-13
Advanced Farming System (AFS)	14-15
1245 Pivot-Transport	16-17
1235 Mounted Stack-Fold	18-19
1215 Rigid Mounted & 1225 Rigid Trailing	20-21
Fertilizer & Granular Chemical	22-23
Attachments & Options	24-25
Precision Planting® Components	26-29
Product Specifications	30-31

# A PROVEN DESIGN FOR HIGHER YIELDS.

## EVERY PLANT COUNTS.

That's why 1200 series Early Riser planters are built on Agronomic Design principles with trusted, field-proven row unit designs that continue to set industry standards and meet the increasing demands of today's operations. Unparalleled accuracy and maximum seed-to-soil contact are driven by multiple patented features you won't find on competitive planters. Season after season, Early Riser planters are engineered to make the most of your planting windows to promote better stands, more uniform emergence and, most important, higher yields.



# FASTER, MORE UNIFORM EMERGENCE.

Accurate seed populations, precise seed depth control, uniform soil density and consistent in-row spacing are key to achieving early, even emergence to give you increased profitability.



## UNMATCHED ACCURACY.

- The 1200 series Early Riser planters set the industry benchmark for consistent row spacing and seed placement accuracy to help achieve uniformity in:
  - Seed-to-soil contact and soil density
  - Seed depth
  - Emergence
  - Ear length
- An **Advanced Seed Meter (ASM)** is engineered to deliver population accuracy, with consistent row spacing and seed singulation.
- **Accu-Stat advanced seed sensing technology** enables the operator to make immediate seed placement adjustments for optimal performance.

## PROVEN TECHNOLOGY.

- Proven planter technologies are engineered to help achieve maximum agronomic performance, including:
  - Ground drive and variable-rate hydraulic drive
  - Section and overlap control with chain drive, cable drive or cable drive with individual row clutches
  - Spring row unit down pressure and air row unit down pressure
- **Advanced Farming Systems (AFS)** helps reduce overlaps and skips, manage inputs by prescription, and monitor planter performance — all from the single-screen AFS Pro 700 display.
- Intuitive operation enables quick-and-easy transport from field to field with fewer, simpler adjustments.

## MAXIMUM UPTIME.

- Built strong to work all day long and over multiple planting seasons.
- Designed to be nimble and flexible, with fewer and easier adjustments and less daily maintenance.
- AccuDrive cable seed meter drive system and efficient seed handling with the Case IH bulk-fill system brings more uptime, reliability and agronomic benefits.

# BETTER THAN PICKET FENCE STANDS. PHOTOCOPY PLANTS.

We often hear about achieving picket fence crop stands, which refers to uniform spacing between corn plants. While many planter manufacturers focus on in-row seed spacing and accurate populations, agronomists agree there are six agronomic principles that impact what many call photocopy plants, which are the most effective way to impact your yield.



## SIX PRIMARY AGRONOMIC DRIVERS OF SEED PLACEMENT ACCURACY WHEN PLANTING.

Producers should consider six agronomic drivers of seed placement accuracy at planting time. Depending on the type of seed and field conditions, certain drivers may have more or less importance:

- 1 Proper seed depth
- 2 Uniformly correct seed depth across the planter and throughout the field
- 3 Good seed-to-soil contact
- 4 Uniformly correct soil pressure all around the seed
- 5 Accurate seed population
- 6 Accurate in-row seed spacing

primary drivers of  
**Photocopy Plants:**  
 potential to impact corn yields by  
**9%–22%**<sup>1</sup>

drivers of  
**Picket Fence Stands:**  
 potential to impact corn yields by  
**2%–4%**<sup>2</sup>

1. Yield impact statistics based upon Purdue University Department of Agronomy Publication AGRY-91-01 "Stand Establishment Variability in Corn".  
 2. Yield impact statistics based upon Purdue University Department of Agronomy Publication AGRY-91-01 "Stand Establishment Variability in Corn".  
 Based on a 200-bushel yield potential and 26,000 to 30,000 seeds per acre with spacing variability with standard deviation of about 2 inches.

## YIELD COMPARISON:

Competitions' Definition of Accuracy – Picket Fence Stands



**1 = one more plant, emerged uniformly or spaced accurately and contributing to yield every 17 ft. 6 in. = 1,000 more plants per acre**  
 1,000 × 0.4 lb. (grain weight of an average ear) = **400 lbs. per acre**  
 400 lbs. per acre/56 lbs. per bushel = **7 bpa increase**  
 7 × \$3.50 × 1,000 acres = **\$24,500 per year**

Case IH Definition of Accuracy – Picket Fence Stands With Photocopy Plants



# EARLY RISER PLANTER: AGRONOMIC BY DESIGN. THE REWARD: INCREASED YIELD AND CASH FLOW.

In side-by-side trials comparing the row unit of the Early Riser planters with competitors, Case IH has collected more than 162,000 measurements. Net Effective Stand Percentage (NESP) data—a measure of photocopy plants—demonstrates the row unit of the Early Riser planters produces a 6% to 10% improvement over conventional row units. Thanks to Case IH Agronomic Design, Early Riser planters consistently produce earlier, more uniform emergence and result in higher yield potential.

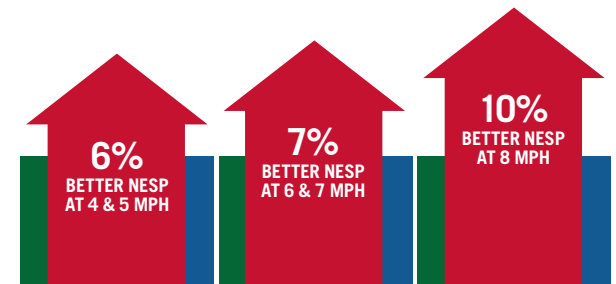

## NET EFFECTIVE STAND PERCENTAGE (NESP).

$$\text{NESP} = \frac{\text{TOTAL PLANT POPULATION} - \text{LATE-EMERGING PLANTS} - \text{POORLY SPACED PLANTS}}{\text{TOTAL PLANT POPULATION}}$$

(plants two or more leaves behind)      (non-picket fence stands)

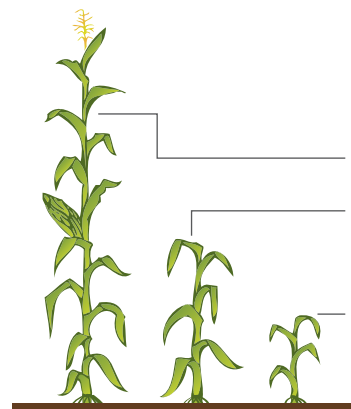

### Identifying Late-Emerging Plants

**Full Potential**—Plants at the same growth stage, where they should be.

**Partial Potential**—Plants one to two leaves behind are actually half “weed.” They do not add to productivity, and they take nutrients from 100% plants.

**No Potential or Weeds**—Any plants that are three or more leaves behind.

## NESP (PHOTOCOPY PLANTS) IMPROVEMENT WITH EARLY RISER PLANTERS COMPARED WITH CONVENTIONAL PLANTERS.

Case IH plots in six states show the row unit of the Early Riser planters, in combination with the Advanced Seed Meter, delivers a 6-10% Net Effective Stand advantage over conventional row units with like options.

The total Early Riser planter system provides, on average, **three days earlier emergence** and, at 4-5 mph planting speeds, **6% more photocopy plants**. If planting corn at 34,000 population, that translates into **10.9 bushels/acre**.

# KEY AGRONOMIC FEATURES TO MARKET.

Since 1981, Case IH has pioneered planter features that deliver functionality, efficiency and accuracy of an Early Riser row unit. Producers who may not need a high-tech planter can still achieve early, more uniform emergence. The 1200 series Early Riser planter is proven to deliver unparalleled plant stands and earlier emergence — on average, three days earlier than competitors.





## SUPERIOR PERFORMANCE.

### ■ Pulled Equalizing Gauge Wheels With Soil Retention Groove — *Introduced 1981*

Prevent soil push and minimize row unit bounce at higher speeds, making it possible to effectively operate in adverse conditions. They also save the moist, loose soil coming out of the trench to cover the seed. Because the grooves also act as a relief area, the gauge wheels do not compress the trench wall, minimizing compaction and making it easier to create uniform soil pressure around the seed. This directly eliminates the need for row coulters tillage to provide loose soil.

### ■ Furrow-firming Point & Seed Shoe — *Introduced 1981*

Furrow-firming point and seed protection shoe eliminate the loose bulk soil left in the seed trench caused by the opener disk. This allows the seed to drop to the bottom of the true “V” trench from the Early Riser planter, improving depth accuracy. And, because no seed wheels or firmers are used in an attempt to press sticky-coated seed into the bulk soil, seeds aren’t dragged or rolled and the integrity of the seed spacing is maintained.

### ■ Narrow Offset Disk Openers — *Introduced 1981*

Penetrate the toughest soils like a sharp knife. Our 10.5-degree staggered double disk openers (versus the competition’s 14-degree nose-to-nose disks) cut through soil and residue better, facilitating uniform depth and providing a narrow seed trench for less soil compaction and sidewall smear. There is no need for row coulters that poke residue into the seed zone and throw moist soil in front of the gauge wheels and opening disk, causing them to rise up, which effects consistent depth.

## TWO-STAGE CLOSING SYSTEM.

### ■ Inverted Closing Disk — *Introduced 1981*

The inverted disk places the moist soil from the bottom of the seed trench back on top of the seed and then gently zips the seed trench closed from the bottom up. This reduces compaction, providing uniform soil density and enhancing moisture conductivity to the seed. The disk also creates a water preference path to the root zone area for improved water management.

### ■ Zero-pressure Ribbed Press Wheel — *Introduced 1981*

The zero-pressure ribbed press wheels seal the trench, preserving moisture, and provide stress crack relief in crusting soils to aid in young plant emergence. The angled treads act as water channels, directing water to absorption paths created by the closing disk.

## PROVEN PLANTING TECHNOLOGY.

### ■ Largest Flat Seed Disc — *Introduced 1999*

Drops seed from the flat side of the disc. Runs slower and smoother through a wider range of speeds for greater seed placement accuracy and higher populations—up to 60,000 seeds at 8 mph with corn.

### ■ Adjustable Singulation System — *Introduced 1999*

Singulates on both sides of the seed disc hole, eliminating doubles and triples, and then drops the seed in the middle of the seed tube, for unmatched population and spacing accuracy.

### ■ Set-It-and-Forget-It Vacuum Seed Meter System — *Introduced 1999*

Minimizes bothersome seed disc changes and tedious vacuum tweaks throughout the season for unmatched ease of use.



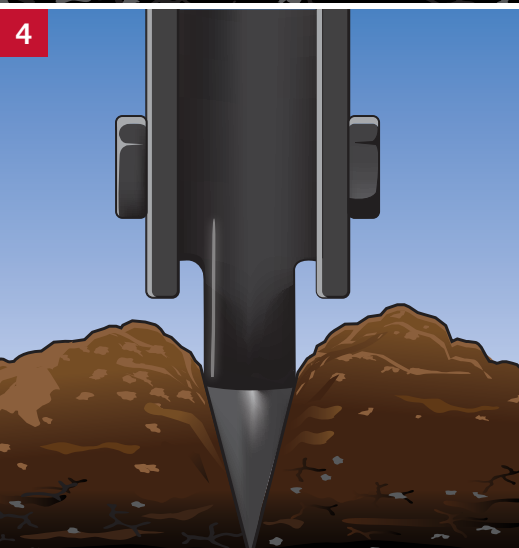
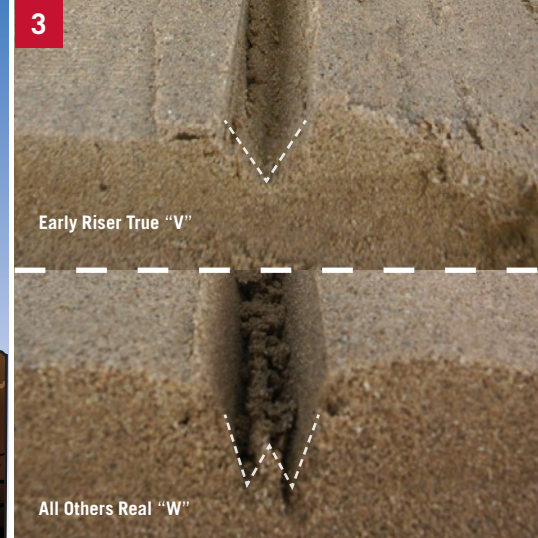
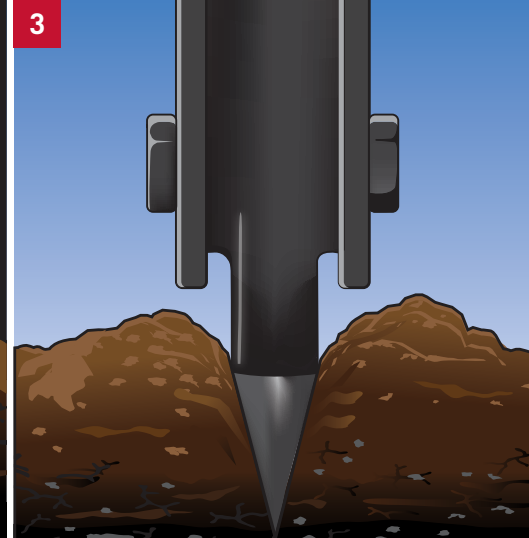
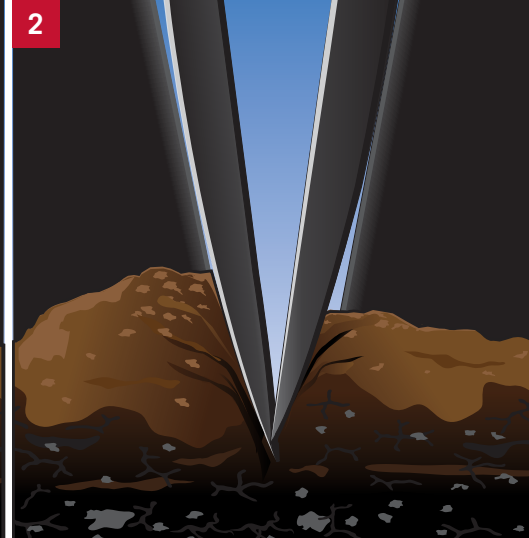

# 12 UNIQUE FEATURES

SET THE INDUSTRY STANDARD FOR EARLIER, MORE UNIFORM EMERGENCE

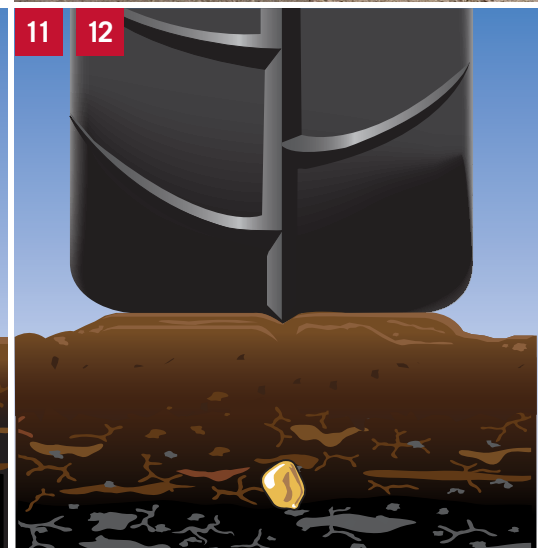
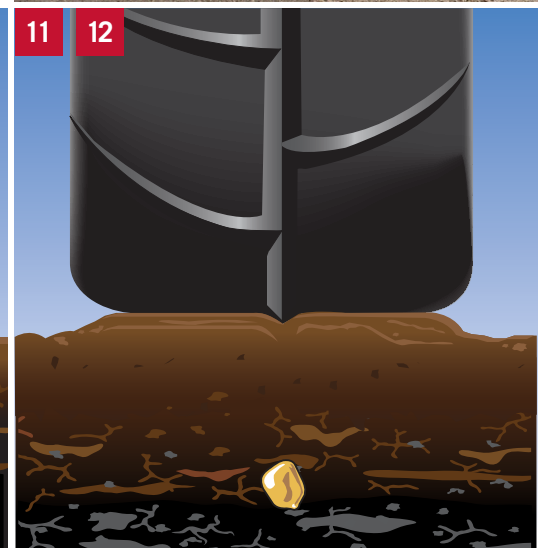
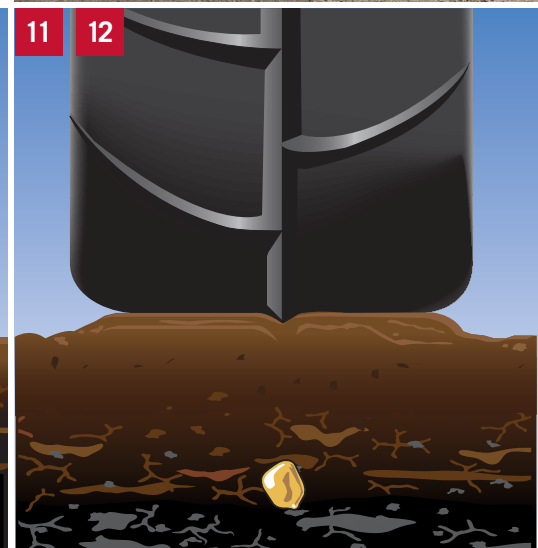
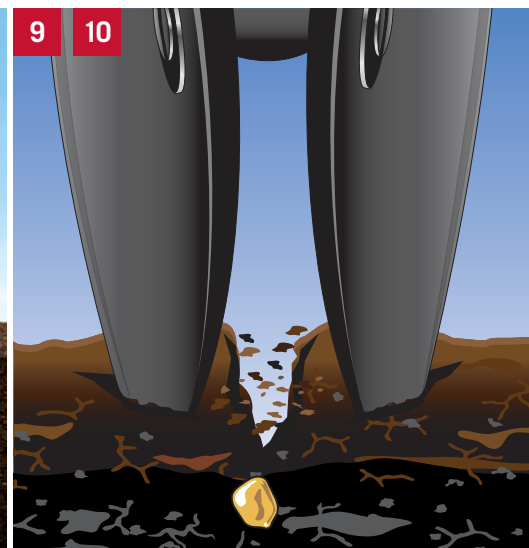
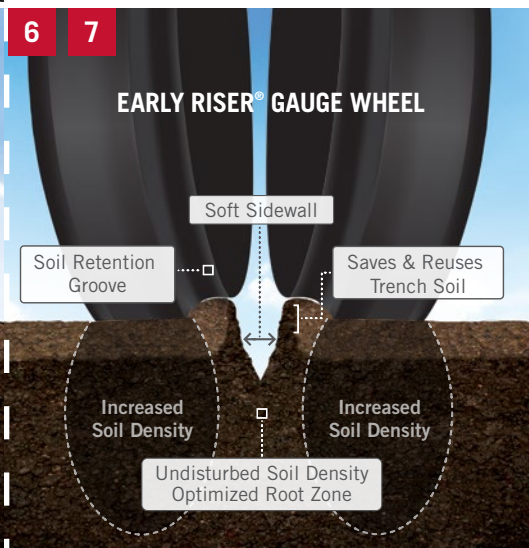
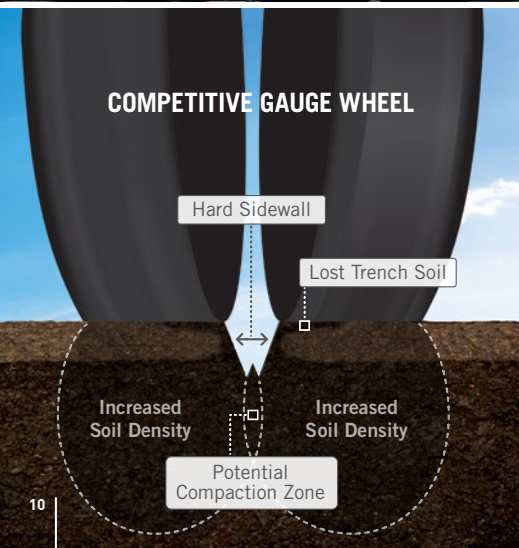
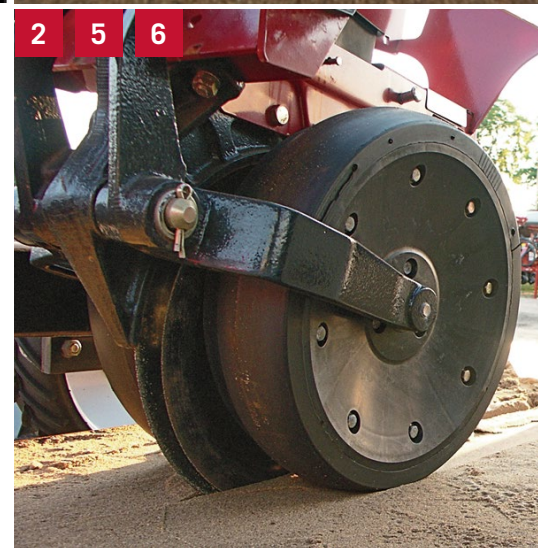

# A ROW UNIT THAT SETS THE STANDARD.

Case IH Early Riser planters are designed with agronomics in mind and have multiple patented features. The legendary row unit of the Early Riser planters has 12 unique features that all contribute to earlier, more uniform emergence as well as the Advanced Seed Meter for accurate in-row spacing and population control.

FEATURE	WHAT IT DOES	RESULT	AGRONOMIC ADVANTAGE
<b>1</b> Narrow, 10.5-degree Openers	Displaces less soil; narrower cut	Less sidewall compaction than other planters with 14-degree openers	Minimizes compaction and seed trench smear for more robust root system
<b>2</b> Leading Edge Offset Openers	Slices through residue and penetrates hard soils	Prevents residue in the furrow	Proper seed depth and good seed-to-soil contact
<b>3</b> Furrow-firming Point	Forms a clean, V-shaped trench	Unlike the W-shaped trench of other planters, there's no ridge or loose soil	Proper seed depth and 360° uniform soil density around the seed
<b>4</b> Seed Protection Shoe	Acts as a retaining wall, preventing loose soil from falling into trench before seed	More uniform seed delivery to furrow	Uniformly correct seed depth across the planter AND throughout the field
<b>5</b> Walking/Pulled Gauge Wheels	Rides up and over obstacles, as opposed to hitting and bouncing over them; similar to the action of a wheel barrow being pulled vs. pushed while at the same time cutting row unit vertical travel in half	Less row unit bounce; more accurate depth	Uniformly correct seed depth across the planter AND throughout the field
<b>6</b> Reduced Inner Diameter Gauge Wheel Tires	Allows displaced soil from opener to move up and out to the sides of the trench. Soil is easily folded down on top of the seed later	Less sidewall compaction	Reduces compaction at bottom of trench for more robust root
<b>7</b> Gauge Wheel Weight Distribution	Gauge wheel profile carries row unit/planter weight 1-3/4 to 2" away from the edge of the seed trench wall	Avoids compression of soil density at the base of the trench and underneath the seed, leaving the seed in a non-compacted state	Emerging plants are healthier, more robust and not as affected by potential tractor or planter-produced compaction
<b>8</b> Zero Indexed Depth Settings (Not Pictured)	Enables all rows to be set to the same depth at 1/8" increments	All seeds planted to same depth across rows	Uniformly correct seed depth across the planter AND throughout the field
<b>9</b> Inverted Furrow Closing Disks	Replaces soil into furrow from both sides so moist soil covers the seed; last soil out is the first soil back in, zipping the trench closed from the bottom up	Improved seed-to-soil contact and proper soil pressure around seed	Uniformly correct soil density all around the seed
<b>10</b> Inverted Closing Disk Grooves	Creates water infiltration paths to the root area on either side of the seed trench	Rain or irrigation water goes quickly where it is needed most	Better water utilization and less erosion foster emergence and more robust root
<b>11</b> Zero-pressure, Internal Dual Rib Sealing Tire	Seals the trench and returns the soil to a similar condition and density as prior to the disk openers disturbing the area	Proper soil pressure 360° around seed and better utilization of moisture	Uniformly correct soil density; minimizes moisture evaporation
<b>12</b> "Cracking" and Water Channel Ribs—Sealing Tips	Sets soil cracking line and channels water to infiltration paths	Defines soil crack in crusting conditions and controls water	Minimizes crusting impact on emergence, slows erosion and channels water to the root zone

# CONSISTENT METERING. EXCEPTIONAL CROP VERSATILITY.

The proven Case IH Advanced Seed Meter (ASM) is engineered to deliver population accuracy with consistent in-row spacing and seed singulation. When equipped with the optional AccuDrive cable drive, producers can plant a wide variety of seed types and sizes. With the largest diameter in the industry, the ASM seed disc also offers more holes than the competition for maximum versatility at higher plant populations.

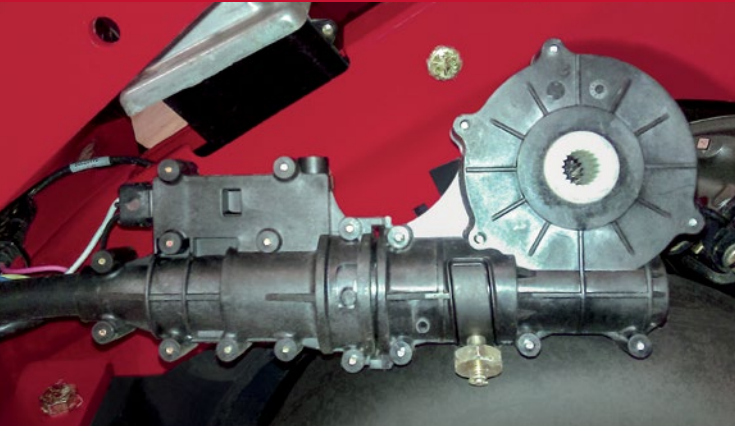

## PROVEN DURABILITY.

- Engineered and carefully built for accuracy, efficiency and trouble-free service in all field conditions, including no-till, minimum-tillage and more.
- More than 40 years of durability testing on the AccuDrive assemblies.
- All the gear components are lubed for life and do not require any upkeep.

## VERSATILITY FOR ALL CROPS.

- The ASM with AccuDrive system meters all corn hybrids and soybean varieties, along with popcorn, cotton, sugar beets, peanuts, edible beans, sweet corn, canola, wheat, sorghum and sunflowers.
- One corn seed disc handles all corn varieties while two soybean seed discs handle all soybean varieties.
- AFS control-equipped planters automatically maintain their target vacuum settings regardless of oil or environmental temperature changes through the day.
- Optional electric drive clutch allows overlap control and row-by-row shut-off for planters up to 16 rows. Planters over 16 rows shut off in pairs. A factory-supplied, dealer-installed attachment allows for row-by-row shut-off for 1200 series planters up to 32 rows.

## PRODUCTIVITY AND RELIABILITY BUILT IN.

- Choose seed based on genetics, quality and price—not the seed size preferences of your planter.
- With the ASM's flat-disc design, seed tumble caused by seed pockets is minimized, providing accurate seed release, more controlled seed drops and improved in-row seed spacing.
- The ASM is built for efficient and trouble-free service.

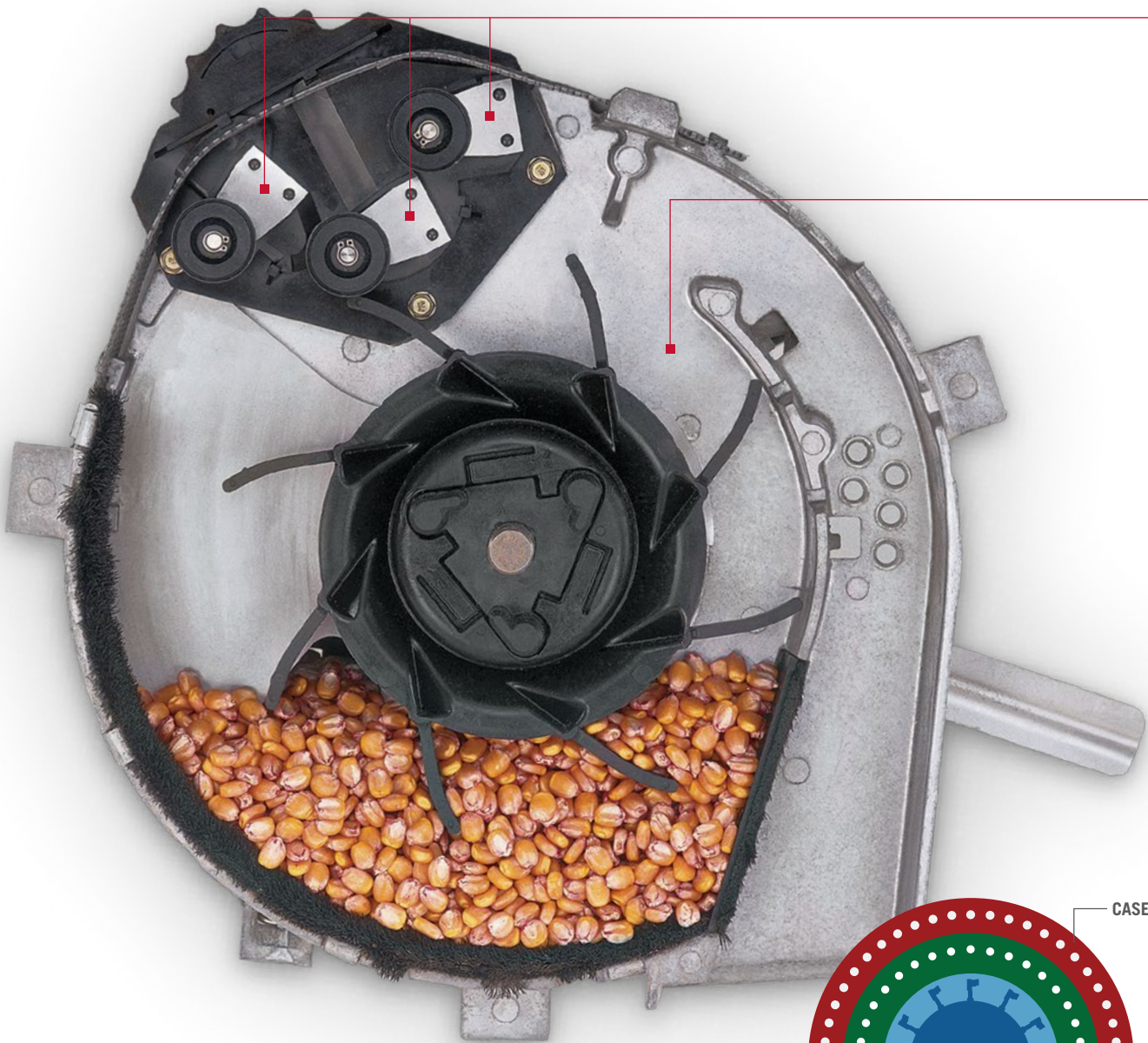

**VIRTUALLY ELIMINATES SKIPS AND DOUBLES.**

- The Case IH seed metering system with three spools singulates on each side of the seed, virtually eliminating skips and doubles and further improving in-row spacing and population accuracy.

**MAKING SEED BRIDGING OBSOLETE.**

- An eight-fingered rotating agitator prevents treated and coated seeds from bridging at the bottom of the meter.

**SEED DELIVERY. PERFECTED.**

- Seed is held only by vacuum—not by seed pockets plus vacuum.
- Eliminates seed tumbling, for more accurate delivery.
- Seed travels precisely down the seed tube and into the furrow.

**SET IT AND FORGET IT.**

- No seed disc changes or vacuum tweaks for corn.
- ASM performs well with treated seeds.
- Meter settings remain the same year after year regardless of seed size.

**MORE HOLES. MORE ACCURACY.**

- Our large-diameter flat corn discs feature 48 holes—for greater accuracy and efficiency.
- Disc rotates more slowly (minimizing centrifugal force) and smoothly, especially when planting higher populations at faster travel speeds.
- Compared with competitors' seed meters which:
  - Have smaller discs with fewer holes and compensate by running their seed disc faster and/or slowing down travel speed
  - This compromises the accuracy of seed placement and/or affects planter productivity
- With the slower seed release of the Early Riser planter, you'll experience greater accuracy, increased productivity and greater profit potential.

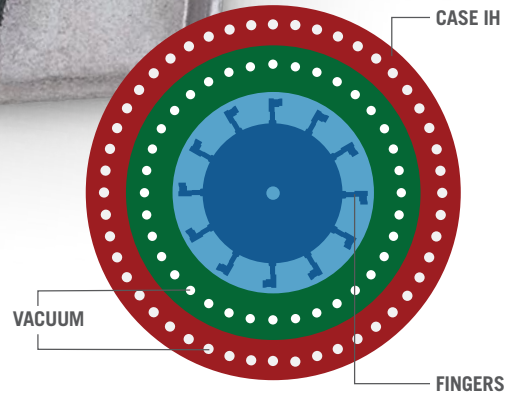

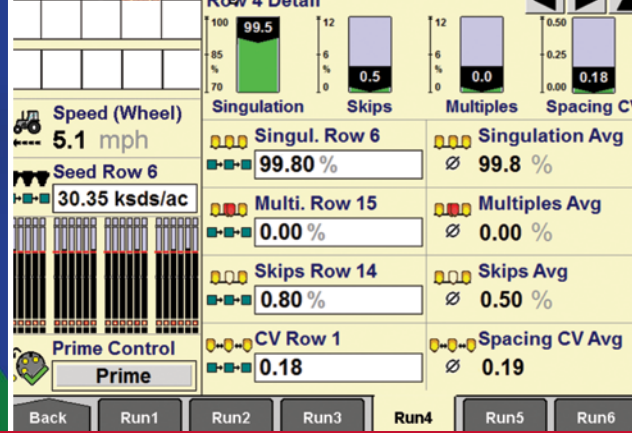
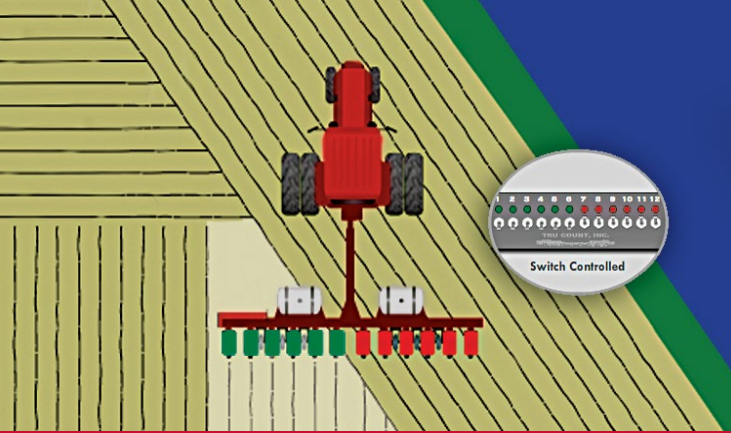

## ADVANCED FARMING SYSTEM (AFS) PRECISION TO MATCH YOUR NEEDS.

Case IH Early Riser planters were the first to offer variable-rate fertilizer and variable-rate seeding. Reduce overlaps and skips or manage your inputs by prescription, based on soils and topography, or monitor planter performance, with the Case IH AFS Pro 700 display and AFS Connect™.



### SAVE SEED WITH AFS ACCUROW CONTROL CLUTCHES.

- AFS AccuRow provides GPS-based row unit shut-off capabilities.
- Automatically disengage rows to avoid overlap and adjust planting rates from the cab.
- Maintenance-free electric row clutch provides precise seed meter engagement/disengagement and single-row groupings.

### ADVANCED SEED SENSING AND SOFTWARE TECHNOLOGY.

- AFS Pro 700 display with Accu-Stat monitors and maps seed activity live, down to each individual row from seed singulation to skips, multiples and spacing variations.
- Provides the spacing coefficient of variation (CV) that gives you the ability to compare the quality of spacing between different populations.
- AFS Accu-Stat is available for corn, popcorn, sugar beets and sunflower crops.

### AFS PRO 700 DISPLAY.

- Connect to GPS with single display for field mapping and prescription farming, control row unit shut-off, and manage variable-rate seed and fertilizer placement.
- Early Riser 1215, 1225 and 8-row 1235 models come standard with the Early Riser IV monitor and offer the AFS Pro 700 display as an option.
- The 1245 and 12/16-row 1235 Early Riser planters come with the AFS Pro 700 display standard.

FEATURE	AFS PRO 700 DISPLAY	EARLY RISER IV MONITOR
<b>EARLY RISER PLANTER FEATURES</b>	<b>ALL MODELS</b>	<b>1215, 1225 &amp; 1235 MODELS</b>
Rate Sensitive Alarm	✓	✓
High/Low Population Warning	✓	✓
Seed Population	✓	✓
Seed Spacing	✓	✓
Row Failure	✓	✓
Average Population	✓	✓
Seed Counter (Row)	✓	✓
Seed Rate Bar (Graph)	✓	✓
Acre Counter (Field)	✓	✓
Total Acreage (Season)	✓	✓
Lifetime Area	✓	N/A
Ground Speed	✓	✓
Area/Hr	✓	✓
Vacuum Rate	✓	N/A
Vacuum Control	✓	N/A
Bulk-fill Fan Rate	✓	✓
Bulk-fill Fan Control	✓	N/A
Bin Level Indicator	✓	N/A
Metric/US Unit Support	✓	✓
Bin Level Alarm	✓	✓
Liquid Fertilizer Control—Single Channel (1245 Only)	✓	N/A
In-cab Pneumatic Down Pressure Control	✓	N/A
Maximum Number of Rows	20 Rows per Section	16
Maximum Number of Seed Drive Sections	4	2 (Frame Box Control)
GPS Control of Seed Drive Shut-off (Overlap & Boundary Control)	✓	N/A
GPS Control of Individual Row Shut-off (AccuRow Control)	✓	N/A
<b>FOLD AND ROW MARKER CONTROL</b>	<b>DISPLAY CONTROL</b>	<b>FRAME BOX CONTROL</b>
1215 Early Riser Planter	✓	✓
1225 Early Riser Planter	✓	✓
1235 Early Riser Planter	✓	✓
1245 Early Riser Planter	✓	N/A
<b>MAP-BASED PRESCRIPTION CONTROL—SEED (VARIABLE DRIVE OPTION ONLY) AND FERTILIZER</b>		
1215 Early Riser Planter	N/A	N/A
1225 Early Riser Planter	✓	N/A
1235 Early Riser Planter	✓	N/A
1245 Early Riser Planter	✓	N/A
Rate Recording Capable (as Applied)	✓	N/A
Accu-Stat: Singulation, Skips, Doubles, Spacing CV Reporting & Recording	✓	N/A
Record Position of Field Marks	✓	N/A
Video Camera Inputs (Total of Three Cameras)	✓	N/A
Compatible With Case IH Combine and Autoguidance AFS Systems	✓	N/A

Note: Case IH 1200 series Early Riser planters are not compatible with ISO11783 displays. All AFS 12\*5 series planters should be operated with the AFS Pro 700 display.

# 1245 *EARLY RISER*

PIVOT-TRANSPORT PLANTER



ROW SPACING	12R 30" (762 MM)		16R 30" (762 MM)		12/23R 30/15" (762/381 MM)		16/31R 30/15" (762/381 MM)		24R 20" (508 MM)	
Frame Size	7" x 7" (18 cm x 18 cm)									
Sections	3									
Hydraulic Seed Drives	2					4				
Main Frame / Wing Tires	(4) 16.5Lx16.1 10PR / (2) 7.60 15 6PR					(4) 16.5Lx16.1 14PR / (2) 7.60 15 6PR				
Wing Flex	± 11°									
Section Flex Points	3R-6R-3R		4R-8R-4R		5R-13R-5R		7R-17R-7R		6R-12R-6R	
Transport L x W x H (With Gran Chem)	38' x 12' 9" x 10' (11.6 x 3.9 x 3 m)		47' x 12' 9" x 10' (14.3 x 3.9 x 3 m)		38' x 12' 9" x 10' (11.6 x 3.9 x 3 m)		47' x 12' 9" x 10' (14.3 x 3.9 x 3 m)			
Min. HP Needed	150 PTO hp		180 PTO hp		210 PTO hp		250 PTO hp		230 PTO hp	
Min./Max. Tractor Hydraulics	13 gpm w-PTO pump/39 gpm					26 gpm w-PTO pump/58 gpm				



# A TWIST ON NARROW-ROAD TRANSPORT.

Designed to easily transition from its fully operational width of 40 feet to a mere 12 feet wide in transport, 1245 Early Riser pivot-transport planters are easy to transport, service and store. Whether you're planting split-row or narrow-row configurations, quickly prepare for transport on command from the comfort of your cab.

## EASY NARROW TRANSPORT.

With the ability to pivot to a narrow transport width and reopen to a ready-to-plant position with the press of a button, every 1245 Early Riser planter saves you time.

## SPLIT-ROW CONFIGURATIONS.

Convert from corn to soybean planting with a few simple adjustments. Get two-planters-in-one efficiency with the ability to plant corn in 12 or 16 rows with 30-inch spacing, and soybeans in 23 or 31 rows with 15-inch spacing.

## NARROW-ROW CONFIGURATIONS.

Reap the yield and agronomic benefits of 20-inch ultranarrow-row-spacing configurations. Increased plant populations use available light more efficiently, and canopy occurs earlier in the season for better weed control and decreased herbicide costs.



# 1235 *EARLY RISER*

STACK-FOLD PLANTER



ROW SPACING	8R 38" (965 MM)	8R 40" (1016 MM)	12R 30" (762 MM)	12R 36" (914 MM)	12R 38" (965 MM)	12R 40" (1016 MM)	16R 30" (762 MM)
Frame Size	7" x 7" (18 cm x 18 cm)						
Sections	3						
Seed Drives	1 Mech Std.; (1 Opt. Hyd.)		2 Hyd Std.; (1 Mech Opt.)			3 Hyd Std.; (3 Mech Opt.)	
Wing Flex	±-8°						
Section Flex Points	2R-4R-2R		3R-6R-3R			4R-8R-4R	
Transport W x H (With Markers)	19' 4" x 11' 11" (5.9 x 3.6 m)		21' 5" x 12' 11" (6.5 x 3.9 m)	26' 4" x 13' (8 x 4 m)		26' 10" x 13' (8.2 x 4 m)	
Hitch	Cat III or IVN						
Min. HP Needed	150 PTO hp		200 PTO hp	205 PTO hp		185 PTO hp	
Max. Tractor Hydraulics	16 gpm						

# STACKABLE. TRACKABLE. PRACTICAL. PRODUCTIVE.

Move faster through — and between — your fields. That's the powerful productivity edge you get with 1235 Early Riser mounted stack-fold planters. The heavy-duty 1235 planter offers stack-and-go portability with in-field trackability, especially on beds and short headlands. Configurations are available to meet the demands of a variety of farms, large and small, with no-till or conventional seedbeds.

## QUICK, CONVENIENT STACKING.

Narrower than a rigid bar planter, a stack-fold design keeps hoppers upright, so there's no need to empty wing hoppers when moving between fields. Simply use one hydraulic remote to quickly stack wings over center.

## EASY TURNS.

Standard gull-wing packages, available on 30-foot and larger versions, provide additional wing clearance while turning and aid in leveling the unit when going back into planting position.

## IMPROVED FLOTATION.

Optional dual gauge wheels are available for working on beds or when additional row unit flotation is required (wide-row spacing only).



# 1215 & 1225 *EARLY RISER*

RIGID MOUNTED & RIGID TRAILING PLANTERS



ROW SPACING	1215 EARLY RISER								1225 EARLY RISER	
Row Spacing	6R 30" (762 mm)	6R 36" (914 mm)	6R 38" (965 mm)	6R 40" (1016 mm)	8R 30" (762 mm)	8R 36" (914 mm)	8R 38" (965 mm)	8R 40" (1016 mm)	6R 30" (762 mm)	8R 30" (762 mm)
Frame Size	7" x 7" (18 cm x 18 cm)									
Sections	1									
Seed Drives	1 Mech								1 Mech or 1 Hyd	
Main Frame Tires	N/A									
Transport W x H (With Markers)	19' 4" x 9' 10" (5.9 x 3 m)	20' 11" x 9' 4" (6.4 x 2.8 m)	21' 9" x 9' 4" (6.6 x 2.8 m)	22' x 9' 4" (6.7 x 2.8 m)	24' 4" x 9' 4" (7.4 x 2.8 m)	26' 11" x 11' 4" (8.2 x 3.5 m)	28' 1" x 11' 4" (8.6 x 3.5 m)	28' 8" x 11' 4" (8.7 x 3.5 m)	17' 3" x 11' 2" (5.3 x 3.4 m)	25' x 9' 5" (7.6 x 2.9 m)
Hitch	Cat III or IIIN								Fixed or Folding Drawbar	
Min. HP Needed	80 PTO hp				100 PTO hp				75 PTO hp	100 PTO hp
Max. Tractor Hydraulics	16 gpm									

# COMPACT AND MANEUVERABLE.

Designed to give you maximum maneuverability in smaller fields, Early Riser 1215 rigid mounted and 1225 rigid trailing planters deliver big planter productivity and precision with a smaller footprint — and a lower investment.

## CUSTOMIZE TO FIT YOUR FARM.

A variety of options are available to add and fit the unique needs of your operation, such as attachments to facilitate liquid or dry fertilizer, or insecticide application.

## 1215 RIGID MOUNTED PLANTERS: SOLID, STREAMLINED DESIGN.

Designed to give you maximum maneuverability in smaller fields, the Early Riser 1215 6- and 8-row rigid mounted planters are perfect for planting cotton, small-seeded peanuts, soybeans and corn. The durable, dependable design features a 3-point mounted bar for pick-up-and-go convenience and fast, easy transport.

## 1225 RIGID TRAILING PLANTERS: GREAT THINGS COME IN SMALL PACKAGES.

Whether you have tight or terraced fields, the Early Riser 1225 planters fit the bill. Compact and streamlined, these machines are available in 6- and 8-row configurations with 30-inch row spacing that's perfect for smaller fields. With a rugged 7 x 7-inch tool bar frame and tough mechanical drive (variable rate hydraulic drive optional), the 1225 planter is built for lasting durability and reliable performance.



# TOOLS AND ATTACHMENTS TO FIT THE WAY YOU FARM.

Is your soil sticky, hard or rocky? What's your preferred agronomic practice—conventional, mulch-till, min-till, or no-till? What mix of fertilizer and treatments do you need to promote faster, earlier seed growth? Here are some of the attachments for Early Riser planters that can help answer those questions. Your Case IH dealer can help you spec out your planter to get the job done the way you want it.

## DRY FERTILIZER AND CHEMICAL ATTACHMENTS AND OPTIONS.

### DRY FERTILIZER.

- Planter-mounted dry fertilizer is available on 6- and 8-row rigid trailing configurations of the 1225 Early Riser planter only.
- Dry fertilizer hoppers hold from 600 to 900 lb. each, depending on the planter configuration.
- Choose from 45 application rates and low-, high- or extra-high-rate augers.
- Perfect for conventional- and mulch-till conditions, the double-disk opener places your exact rate in the right place.
- For no-till fields, opt for the single-disk opener with 17 in. rippled coulter.
- A knife scraper can be added to keep openers clean.
- Optional gauge wheels allow for placement 3 or 4 in. deep.

### GRANULAR CHEMICAL APPLICATIONS.

- Granular chemical hoppers hold 70 lb. of either herbicide or insecticide, or 35 lb. of each when used with a conversion divider.
- Large dials are easy to set and adjust to your desired rates.
- Several application attachments are available, allowing the ability to surface apply, apply in-furrow or T-band your insecticide (granular chemical is available on all configurations).
  - For insecticide application, a front or rear insecticide spreader puts chemical in a narrow band either before and/or after the press wheel.
  - An in-furrow hose places insecticide in the seed trench.
  - Add a closed handling SmartBox® system to reduce operator exposure.
- For herbicide application, a rear-mounted herbicide spreader handles distribution over the closed furrow.
  - Add a herbicide windshield when banding on windy days. You can follow application with a spring-tooth incorporator to help mix soil and chemicals.



## LIQUID FERTILIZER ATTACHMENTS AND OPTIONS.

### LIQUID FERTILIZER.

Promote faster, earlier seed growth by applying liquid starter fertilizer during planting.

- Large-capacity polyethylene tanks hold 70 to 230 gallons each and can be mounted on the toolbar or your tractor, depending on the planter configuration.
- A bulk-fill system allows easy single-point filling.
- Planter-mounted liquid fertilizer is available on 1225 6- and 8-row rigid trailing configurations as well as 12- and 16-row 1245 pivot-transport planters with on-row hoppers.
- Some planter models can be equipped with a Case IH piston pump meter or a high-output diaphragm pump for greater reliability and lower maintenance.
- Liquid pump capacities range from 5 to 25 gallons per acre on 30 in. row spacing with six orifice sizes available to match your gallons-per-acre requirement and planting speed.
- Tractor-mounted fertilizer tank and plumbing kits are available.

### OPTIONS TO MEET YOUR NEEDS:

- A double-disk opener works well in conventional- and mulch-till fields.
- The single-disk no-till opener with fertilizer knife features a durable, 17-in. (432 mm) rippled coulters and parallel linkage for mulch-till and no-till field conditions.
- A single-disk opener with liquid injection (pivot planters only) allows you to place fertilizer right where you need it. The opener's flex-mounted injection nozzle and 25-wave coulters blade work well with most soil management practices and soil types.
- Parallel linkage ensures stability for optimum placement.



# ATTACHMENTS AND OPTIONS TO SUIT YOUR SOILS.

Case IH offers a number of row unit attachments and options designed to increase the versatility and performance of your Early Riser planter in a variety of soils or situations. From heavy-duty down pressure springs that provide extra force in hard soil conditions to rotary scrapers designed to prevent excess dirt buildup, Case IH row unit attachments and options help you achieve the most productive, efficient and accurate planting while protecting your equipment.



## GUARD ATTACHMENTS.

To prevent residue-wrap and damage from dirt clods, guard attachments are available. The drive-wheel chain guard protects critical components from residue and clods in mulch-till and no-till fields.

## BAR ROCK GUARD.

With the bar rock guard, you can keep rocks from wedging between the drive wheel and gauge wheel. Used in combination with a wheel cover, this prevents rocks and dirt clods from damaging the tire valve stem.

## DOWN PRESSURE SPRING.

Add a heavy-duty down pressure spring (available through CNH Industrial Parts & Service) to the dual closing disks for extra force to cover the seed trench in hard soils.





### **NARROW NO-TILL RESIDUE MANAGER.**

Matches performance of floating row cleaners for 30-in. rows. Dual managers power through the toughest residue without creating undesirable soil disturbance. High-strength steel arms can be set to float and follow the soil contour or locked down to hold the wheels firmly in place. Comes standard with depth bands.



### **TINE RESIDUE MANAGER.**

Sweep away residue from the path of openers with the Early Riser tine residue manager. Each 13-in. (330 mm) steel wheel has 16 fingers to clear stalks and trash out of the way. Adjust working depth shallow enough for minimal soil disruption. Available in both a fixed configuration and a floating configuration with depth bands.



### **NO-TILL RESIDUE MANAGER.**

No-till residue managers are for heavy, no-till residue situations. Available in both a fixed configuration and a floating configuration with depth bands.

# SIMPLE TECHNOLOGY TO MAXIMIZE YOUR FARM.

Your Case IH 1200 series Early Riser planter comes ready to integrate Precision Planting technology for the latest in precision agriculture technology. You get one chance each season to plant your crop, so make sure your planter is ready to perform. The 20|20® monitor, vSet®, vDrive®, DeltaForce®, SpeedTube®, Conceal® and FurrowForce™ are just a few of the Precision Planting products that can further improve the performance of your Case IH 1200 series planter.

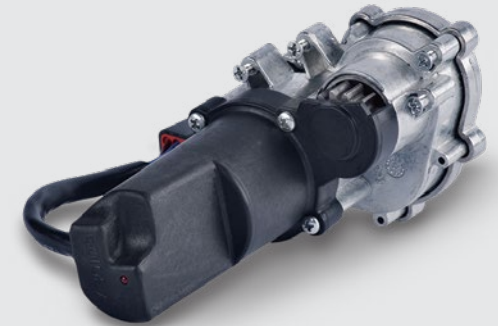

## 20|20.

Data drives decisions.

Using data to help drive decisions on your farm is nothing new to you, but you need the right data for the job. The 20|20 monitor gives you the real-time data you need to make better decisions for your next pass for your next season and throughout the future of your operation.

- Powers most Precision Planting systems from population, downforce, liquid, multi-hybrid and high-speed planting
- Senses and monitors the furrow, seeding, spacing and liquid application
- Provides a foot-by-foot agronomic view of your field
- Helps you make better decisions in the moment

## vSet.

Effortless meter accuracy.

We know that you want to have great-looking crop stands. To do that, you need a meter on your planter that never makes a mistake. But many meters need a certain seed size or quite a bit of adjustments to do a decent job.

- Requires no meter adjustments with different seed sizes
- Incredibly accurate with singulation accuracy in corn and soybeans of over 99% with no adjustment to vacuum, disk or the singulator
- Easy to maintain

## vDrive.

Electric drive that gives you a picket fence stand.

Fixing issues that pop up on mechanical drive systems can cause costly downtime while planting. Downtime means frustration, loss of ideal planting hours and missed family activities.

- Replaces the mechanical drive system, saving you from a bearing going out or having a chain issue
- Allows you to save on seed with row shut-off at a boundary or where you have already planted
- Works with the vSet meter to provide you a picket fence stand, no matter the crop
- Pairs with the 20|20 monitor to simplify how seed and insecticide meters operate

# HIT THE PLANTING WINDOW AND PROVIDE THE HIGHEST YIELD.

Favorable planting conditions may be short-lived so you must take advantage of your planting window and reduce planting variables.



## **vApplyHD®**

**Accurate liquid control made simple.**

vApplyHD is the industry-first, on-row liquid control product that incorporates flow measurement and control into a single device. The row-by-row features include turn compensation, swath, automatic flow balancing and variable rate prescription execution. The module is easy to install, simple to use and designed with industry-leading flexibility. The vApplyHD module is used, without modification, from the lowest pop-up rates on the planter to the highest sidedress rates, across the full range of speeds.

- Easy to install and simple to use
- Improves application distribution
- Reduced hardware complexity

## **DeltaForce.**

**Automated downforce control that has been proven on hundreds of thousands of rows.**

Determining what downforce setting to use is challenging, especially when you have known and unknown variability in the field. You know one setting for the whole field isn't right, so why not install a system that can take the guesswork out of it for you?

- Replaces the springs or airbags with hydraulic cylinders and load cells to measure weight on the row unit gauge wheels
- Measures, then adds or removes weight on the row unit automatically, so gauge wheels always have consistent weight on them.
- Adjusts your planter's downforce to changing field environments on each row
- Gets every seed in the ideal environment

## **SpeedTube.**

**Hit the planting window, all while keeping seeds under control and in their place.**

Every farmer knows time and weather play a vital role in your season. A planter equipped with SpeedTube allows you to double planting speed without sacrificing seed placement, so you can cover more acres per hour when it's go time.

- Hits the planting window that provides the highest yield
- Controls the seeds so there is no bouncing in the tube and no tumbling in the furrow
- Allows more acres to be covered during the ideal planting window without the need for larger planters or more manpower

# CREATE THE PERFECT ENVIRONMENT FOR SEEDS TO THRIVE.

The ideal environment should be one where fertilizer is placed consistently and there is no evidence the planter ever created a furrow, placed seed and closed the furrow.

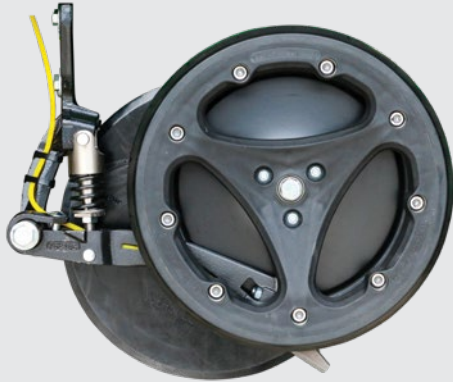

## **Conceal.**

Planter nitrogen placement without the headaches.

Broadcasting nitrogen before planting is an inefficient means of getting fertility to the plant. We only plant a row every few feet, so why spread fertilizer evenly across the entire field? Apply nitrogen at the right time, in the right way.

- Puts either a single or a dual band of nutrients down beside the row
- Consistently places fertilizer the same distance from the seed
- Places the fertilizer at a consistent depth relative to the seed

## **FurrowForce.**

Create the perfect environment for seeds to thrive.

FurrowForce changes closing entirely, addressing all aspects of managing soil density through the unique design as an automated two-stage closing system with integrating sensing. The first stage closes the trench from the bottom up to eliminate air pockets, and the second stage stitch wheels firm the soil for moisture retention, fully managing the seedbed environment for consistent germination.

- No slotting or air pockets
- Mellow path to the surface
- Moisture retention in loose soil



1225 CASE II EARLY RISER

CASE II

CASE II

## EARLY RISER 1200 SERIES PLANTER SPECIFICATIONS

EARLY RISER MODEL	1215 RIGID MOUNTED								1225 RIGID TRAILING				1235 STACK FOLD						1245 PIVOT TRANSPORT					
<b>CONFIGURATION</b>																								
Rows	6R	6R	6R	6R	8R	8R	8R	8R	6R	8R	8R	8R	12R	12R	12R	12R	16R	12R	16R	12/23R	16/31R	24R		
Spacing (in.)	30"	36"	38"	40"	30"	36"	38"	40"	30"	30"	38"	40"	30"	36"	38"	40"	30"	30"	30"	30"/15"	30"/15"	20"		
Spacing (mm)	762	914	965	1016	762	914	965	1016	762	762	965	1016	762	914	965	1016	762	762	762	762/381	762/381	508		
<b>HITCH</b>																								
2-Point Hitch	Optional with available lift assist wheels								N/A				Optional with available lift assist wheels						N/A					
3-Point Hitch	Standard								N/A				Standard						N/A					
Fixed Drawbar	N/A								Standard										N/A					
Folding Drawbar	N/A								Available										N/A					
Hydraulic Telescope Drawbar									N/A										Standard					
<b>SEED FEEDING SYSTEM</b>																								
On-row Hopper 1.9 bu									Standard										Optional		N/A			
Bulk-fill Standard bu									N/A												80			
<b>DRIVES</b>																								
Mech Trans	1 Standard												Available						N/A					
Hydraulic Drive	N/A								1 Available				2 Standard		3 Std.		2 Standard		4 Standard					
Dual Arm Carrying Wheel Support	Standard								N/A				Standard						N/A					
Chain Guards									Available										N/A					
Rock Guards	N/A								Available										N/A					
Hydraulic Supply <sup>1</sup>	N/A								Opt. 14 gpm				N/A						Std. 22 gpm, Opt. 36 gpm		Std. 36 gpm, Opt. 22 gpm			
<b>LIFT ASSIST / FLOTATION</b>																								
Wheel Lift Assist	Available								N/A				Available		Std.		N/A							
Wing Turn Assist (Gull Wing)	N/A												Standard						N/A					
Hi Float Wing Wheels (Standard)									N/A										9.5L x 15					
<b>ROW UNIT</b>																								
4.5 in. (114 mm) Gauge Wheel									Standard								N/A		Standard					
Dual Gauge Wheel	N/A	Available		N/A	Available		N/A	N/A		Available		N/A	Available		N/A									
3.5 in. (89 mm) Narrow Gauge Wheel	Optional																							
Spring Down Pressure									Standard										Available					
Pneumatic Down Pressure									N/A										Standard					
Two-stage Closing System													Standard											
AccuRow Electric Clutch (Factory) <sup>2</sup>													Available											
<b>METER DRIVE</b>																								
Chain Drive									Standard										Available					
AccuDrive Cable Drive									Available										Standard					

N/A = configuration not available. Standard = in base price of the planter. Available = multiple options available. Opt. = option, followed by the optional specification.

EARLY RISER MODEL	1215 RIGID MOUNTED								1225 RIGID TRAILING				1235 STACK FOLD				1245 PIVOT TRANSPORT								
<b>CONFIGURATION</b>																									
Rows	6R	6R	6R	6R	8R	8R	8R	8R	6R	8R	8R	8R	12R	12R	12R	12R	16R	12R	16R	12/23R	16/31R	24R			
Spacing (in.)	30"	36"	38"	40"	30"	36"	38"	40"	30"	30"	38"	40"	30"	36"	38"	40"	30"	30"	30"	30"/15"	30"/15"	20"			
Spacing (mm)	762	914	965	1016	762	914	965	1016	762	762	965	1016	762	914	965	1016	762	762	762	762/381	762/381	508			
<b>MARKERS</b>																									
Markers <sup>3</sup>	Available								Standard				Available				Standard								
<b>MONITOR SYSTEM</b>																									
Early Riser IV Monitor									Standard				Available				N/A								
AFS Pro 700 Display									Available				Standard				AFS Pro 700 Only								
SmartBox <sup>®</sup> Compatible													Optional												
<b>GRANULAR CHEMICAL</b>																									
Granular Chemical <sup>4</sup>																	Available (requires chain drive)								
<b>FERTILIZER SYSTEM</b>																									
Rear Towing Hitch																	N/A								
Dry	N/A								Opt. 1,800 lb.				Opt. 2,400 lb.				N/A								
Liquid With Tanks On-row Hopper	N/A								Opt. 220 gal.				Opt. 280 gal.				N/A				Opt. 400 gal.	N/A			
Liquid With Tanks Bulk-fill																	N/A								
Liquid Without Tanks (Tractor Mtd. Tanks)									N/A								Available								
<b>FERTILIZER COULTERS</b>																									
Double Disk	N/A								Available				N/A				Available								
No-till Coulter With Knife	N/A								Available				N/A				Available								
No-till Coulter With Injector									N/A								Available								
Single Disk																	N/A								
<b>ROW UNIT TILLAGE</b>																									
9.25" Furrowing Disk																	Available								
12" Furrowing Disk																	Available								
12" Notched Disk																	Available								
V-Wings	Available								N/A								Available								
25 Wave Coulter																	Available								
Non-floating Tine Residue Mgr																	Available								
Non-floating No-till Residue Mgr																	Available								
Floating Tine Residue Mgr									N/A								Available <sup>5</sup>								
Floating No-till Residue Mgr									N/A								Available <sup>5</sup>								
Floating Tine Residue Mgr With Coulter									N/A								Available <sup>5</sup>								
Floating No-till Residue Mgr With Coulter									N/A								Available <sup>5</sup>								

<sup>1</sup> Direct Drive (Tractor supplied hydraulics) available on all models.

<sup>2</sup> For use only with AccuDrive cable meter drive.

<sup>3</sup> Available deduct for all standard markers.

<sup>4</sup> Granular chemical comes with a 70-lb. box capacity and (1) meter. The box can be split and dual meters installed. Factory Gran Chem only available with Chain Driven Advanced Seed Meters. Not for use with AccuDrive. SmartBox mounting supports available through parts for use with AccuDrive.

<sup>5</sup> Not available when double disk fertilizer coulters are used.



SAFETY NEVER HURTS!™ Always read the operators manual before operating any equipment. Inspect equipment before using it, and be sure it is operating properly. Follow the product safety signs, and use any safety features provided. CNH Industrial America LLC reserves the right to make improvements in design and changes in specifications at any time without notice and without incurring any obligation to install them on units previously sold. Specifications, descriptions and illustrative material herein are as accurate as known at time of publication, but are subject to change without notice. Availability of some models and equipment builds varies according to the country in which the equipment is used.

©2020 CNH Industrial America LLC. All rights reserved. Case IH is a trademark registered in the United States and many other countries, owned by or licensed to CNH Industrial N.V., its subsidiaries or affiliates. Any trademarks referred to herein, in association with goods and/or services of companies other than CNH Industrial America LLC are the property of those respective companies. Printed in U.S.A. [www.caseih.com](http://www.caseih.com)

CIH20042102