

Rotary Rakes



www.kuhn.com

GA SINGLE-ROTOR RAKES

Trailed and Mounted

NEW
FROM KUHN

GA 4230 T & 4231 T

13'10" (4.2 m) Approximate Working Width



Invest in Quality®



HIGH-QUALITY ROTARY RAKES FROM THE WORLD LEADER



GENTLE, HIGH-QUALITY RAKING

Long, flexible tines touch the crop just once, lifting and placing it neatly into the windrow. This raking action allows the hay to be raked damp and dry down completely in the windrow. For crops such as alfalfa, this gentle handling is especially important as it ensures the leaves will remain intact. This superior windrow formation allows for more efficient harvesting since the crop is not roped as compared to other rakes.

EXCEPTIONAL PERFORMANCE AND LOW MAINTENANCE

The exclusive Masterdrive® gearbox sets the bar for reliability and long life. The patented double reduction design provides the versatility to handle a wide range of crops and high volumes. The result is outstanding performance even in the most challenging conditions.

SAVE TIME AND MONEY

Saving time means reduced production costs. KUHN rotary rakes provide fast, efficient operation while maintaining high-quality raking to maximize the nutrient value of your forage.

ROTARY RAKES

Single-Rotor Rakes
in brief

Models	Working Width	Horsepower Requirement	Windrow Delivery	Rake Type
GA 300 GM	10'6" (3.2 m)	20 hp (15 kW)	Left	Mounted
GA 3200 GT	10'6" (3.2 m)	20 hp (15 kW)	Left	Trailed
GA 3201 GM	10'6" (3.2 m)	20 hp (15 kW)	Left	Mounted
GA 4121 GM	13'5" (4.1 m)	30 hp (22 kW)	Right	Mounted
GA 4230 T	13'10" (4.2 m)	30 hp (22 kW)	Right	Trailed
GA 4231 T	13'10" (4.2 m)	30 hp (22 kW)	Right	Trailed
GA 4321 GM	13'9" (4.2 m)	30 hp (22 kW)	Right	Mounted
GA 4731 T	15'3" (4.7 m)	35 hp (26 kW)	Right	Trailed
GA 5031 T	16'4" (5.0 m)	40 hp (29 kW)	Right	Trailed

UNIFORM AND FLUFFY WINDROWS

Double-curved tine arms are designed to form fluffy and straight windrows for superior raking quality at high speeds. Fluffy windrows allow more air movement through the crop promoting fast and uniform drying!

KUHN rotary rakes achieve this by following two basic principles for ideal windrow formation. First, the tine arms maintain a positive forward position right up to the point where the forage is delivered to the windrow ensuring gentle crop handling and minimal ash incorporation. Second, a steep cam track allows the tines to be raised very quickly to provide additional clearance over the windrow. These principles allow KUHN rotary rakes to create fluffy, uniform windrows that let air and sunlight in for faster drying.

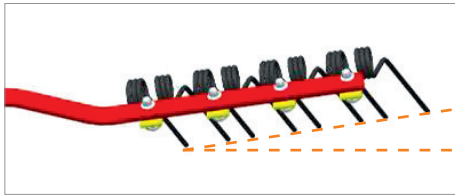

IMPROVED WINDROW FORMATION

On GA rotary rakes, tine arms are not only positioned tangentially, but hyper tangentially (except GA 300 GM and GA 3201 GM), meaning that they reach a 90° angle towards the windrow very late in their rotation. This, combined with the tine arms riding on a steep cam track, allows the tines to be raised very quickly when depositing into a windrow. This is ideal for forming fluffy and straight windrows for superior raking quality at high speeds. Fluffy windrows allow more air movement through the crop promoting faster drying!

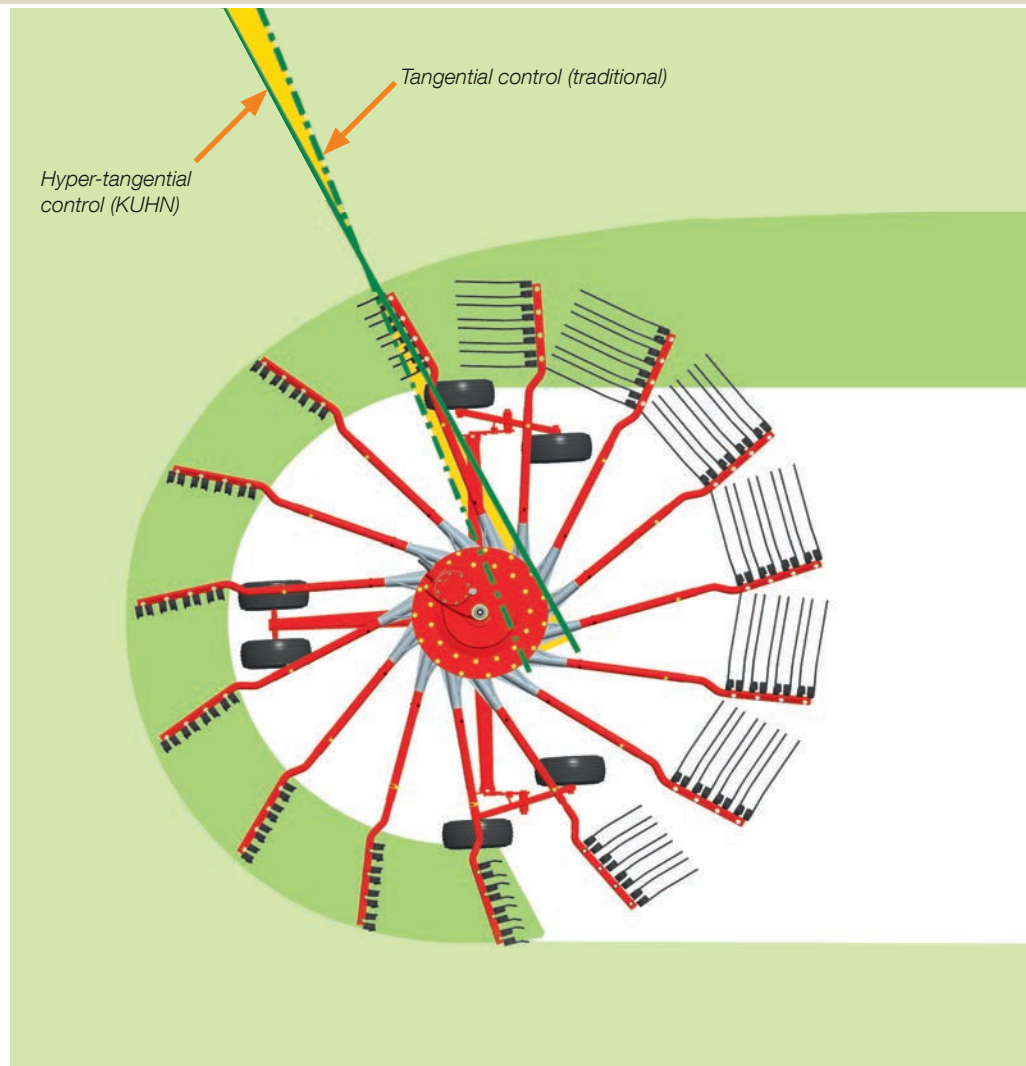

ADVANTAGES OF DOUBLE-CURVED TINE ARMS

The double-curved tine arms on KUHN rotary rakes provide a number of advantages for operators. These rakes create larger and fluffier windrows for easier crop pickup by either a baler or forage harvester. The rake gently lifts the crop by keeping the rake tines parallel with the machine. This means there is virtually no risk of pulling the crop out of the formed windrow or incorporating dirt and ash content into it.



HEAVY-DUTY TINES

KUHN tines rake the crop gently, yet thoroughly, even in dense, heavy crop. Their heat-treated steel construction helps ensure a longer service life and maximum resistance to fatigue. The floating tine attachment features large-diameter coils that reduce the risk of wear.

The tine height is easily and accurately controlled to collect all of the crop and not damage the stubble. As with all rotary rakes, proper tine height adjustment is essential to maximize service life.



CLEANER WINDROWS

The rotor wheels on KUHN rotary rakes are positioned extremely close to the tines. This allows the tines to closely follow ground contours to avoid impurities and produce cleaner windrows.

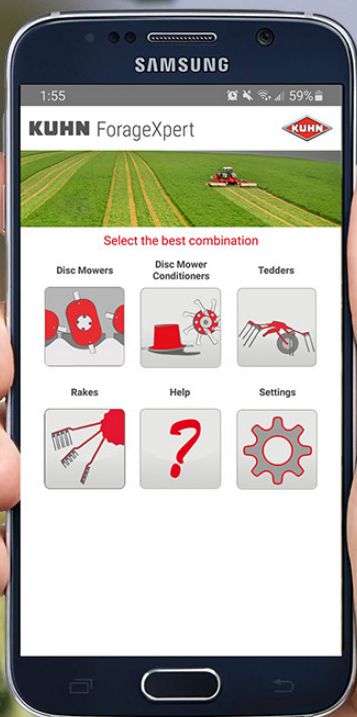

KUHN ForageXpert

This application is available to help you find mowers, mower conditioners, tedders, rakes and mergers to best meet the needs of your operation. It will allow you to optimize your forage harvesting needs according to your current or future equipment purchases.



MASTERDRIVE® GIII GEARBOX CROSS SECTION

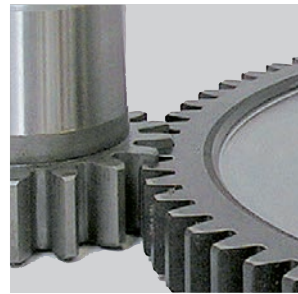
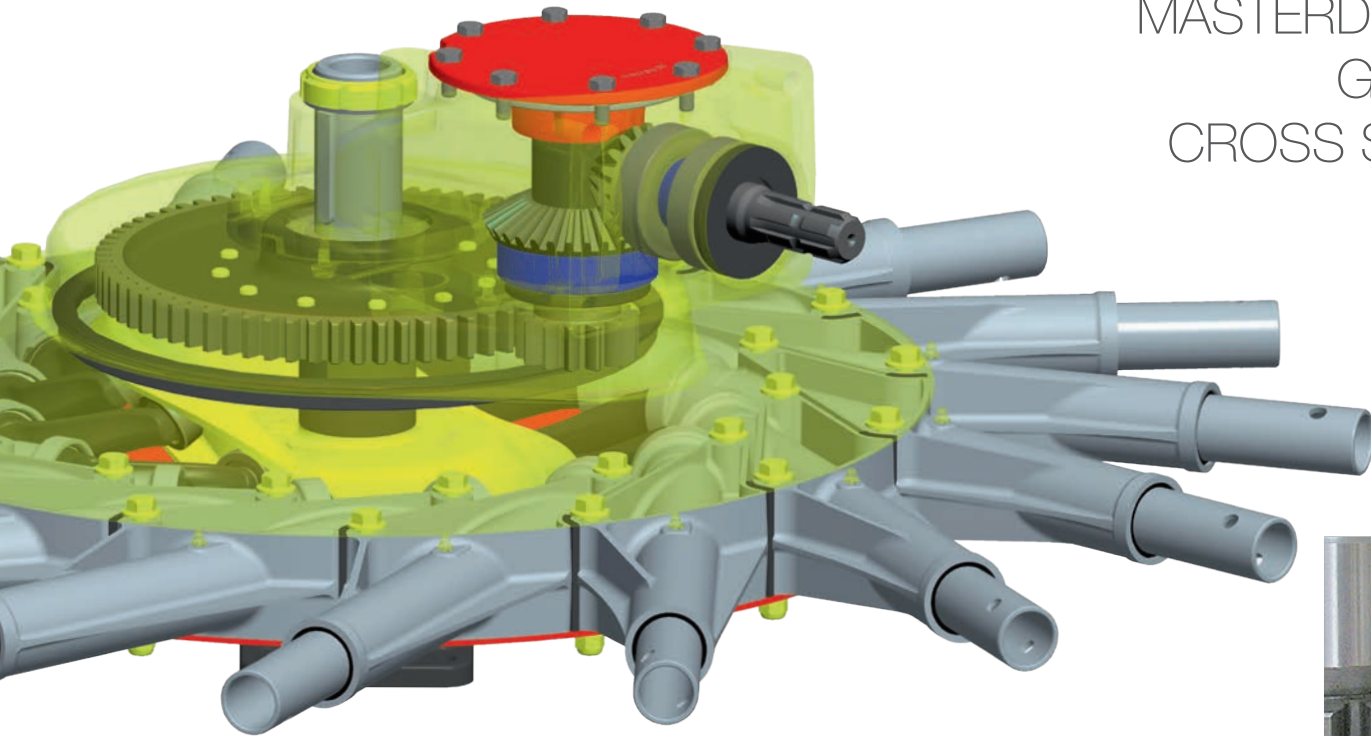

*No uneven contact
when driving over
rough terrain*

THE MASTERDRIVE® GEARBOX: MASTER TOUGH CONDITIONS

Today's agricultural machines need to withstand more stress as working widths increase and there is greater demand for maximum service life. For rotary rakes this is particularly true for the heart of the machine – the rotor drive. KUHN has developed fully enclosed gearboxes for total protection of the drive parts and less wear. The Masterdrive gearbox has an over-built design that provides exceptional reliability and durability during intensive operation.

KUHN PATENT

The Masterdrive gearbox has an exclusive two-stage reduction drive with bevel and bull gears. Tolerances in the bevel reduction are tightly controlled for exceptional reliability and increased life of the entire assembly in difficult conditions.

With this system, wear on the gears is reduced to a minimum and almost no maintenance is required. The two stages also make it possible to include bigger bull gears with more teeth for better power transmission.

	Fully enclosed single-stage gearbox	Masterdrive double-reduction gearbox	Masterdrive GIII double-reduction gearbox
GA 300 GM	●	-	-
GA 3200 GT	●	-	-
GA 3201 GM	●	-	-
GA 4121 GM	-	●	-
GA 4230 T	-	-	●
GA 4231 T	-	-	●
GA 4321 GM	-	●	-
GA 4731 T	-	-	●
GA 5031 T	-	-	●

MAXIMUM STABILITY IN ALL CONDITIONS

The nutritional quality of forage is the most important factor in achieving higher feed performance. Faster harvesting, without reducing forage quality, is the key to lower costs and increased milk production or a higher rate of gain. KUHN rotary rakes are built with key features to help you make these goals a reality.

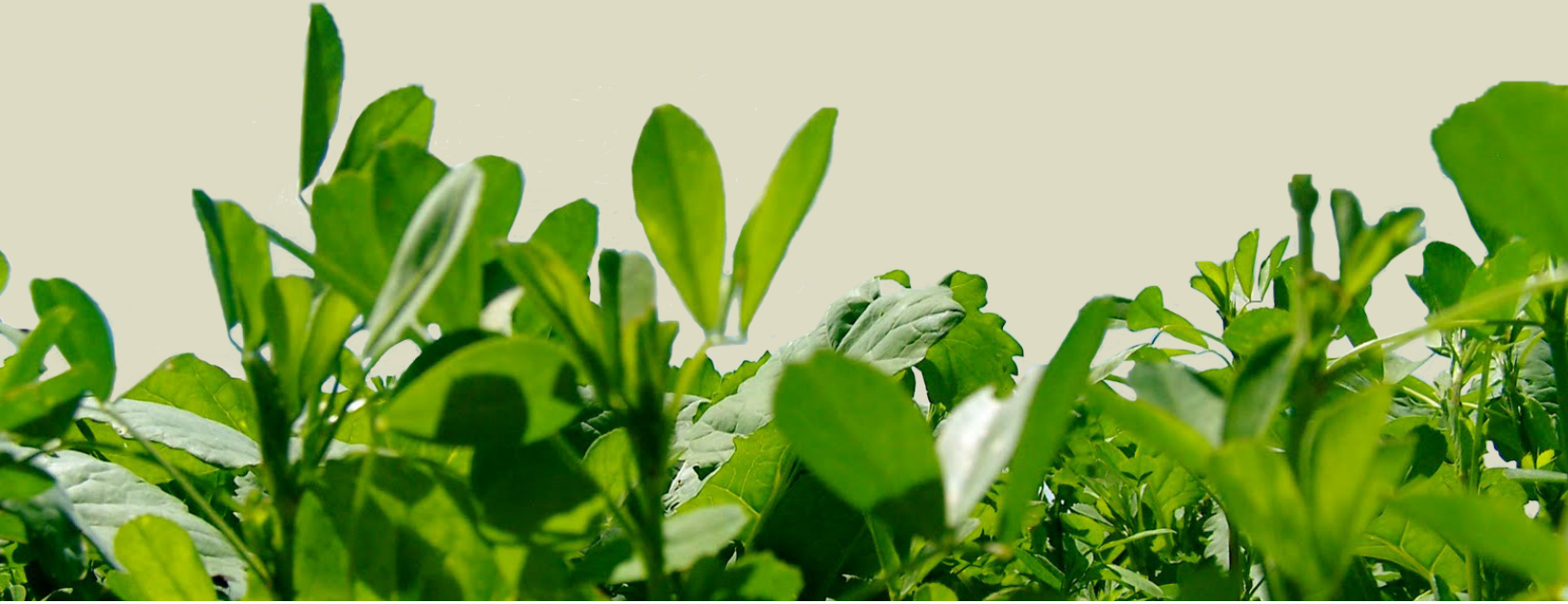

TRAILED MACHINES FOR FAST HOOKUP

The simple clevis hitch, offered on GT and T models, allows you to quickly hookup and go. The design of the tongue keeps the clevis connecting point square with the drawbar on hydraulic lift models.



MOUNTED FLEXIBILITY WITH TRAILED PERFORMANCE

Most of KUHN's mounted rotary rakes feature a pivoting headstock (GM models) and perform in the same way as a trailed machine when raking. Working while turning does not alter the raking quality or windrow shape. This allows you to make faster turns with complete safety and helps ensure faster, easier harvesting even in tight field corners.



CUSHIONED SUSPENSION

The headstock suspension is standard on GA 4321 models and optional on 4121 models. This suspension system acts as a cushion while maneuvering in the field and improves stability when working on slopes. When raising the rake, the dampener smoothly and automatically centers itself behind the tractor. For the GA 4321 model, a second dampener can be added for working in very hilly areas.



ROTARY RAKES GA 300 GM

DECADES OF PROVEN RELIABILITY

As the pioneer of rotary rakes with guided tine arms, KUHN rotary rakes have always been considered the premier rotary rakes available on the market. The 3-point mounted GA 300 GM is no exception to this rule. With these machines you can obtain superior raking performance, while keeping the leaves of your crop intact and allowing you to harvest at its peak nutritional value.



NO MAINTENANCE REQUIRED

The tine arm drive components are housed in a fully enclosed gear case and do not require any special maintenance. For additional durability, the tine arm holders are fixed on both the upper and lower gear case covers.

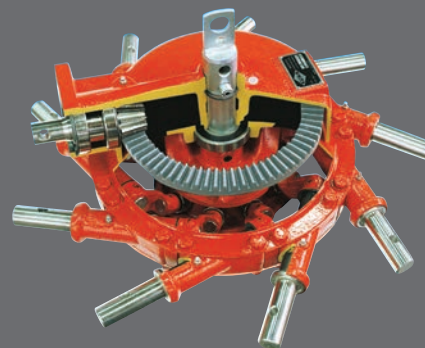

GEARBOX
fully enclosed,
single-stage
bevel gear

NO COMPROMISES IN RAKING QUALITY

The nine tine arms of the GA 300 GM follow a cam profile that provides high clearance over the windrow. The pivoting headstock allows increased maneuverability and improved terrain following.

FULLY EQUIPPED FOR LOW AND MEDIUM HORSEPOWER TRACTORS

The GA 3201 GM and GA 3200 GT are the right machines for farms with smaller acreage and low or medium horsepower tractors. Equipped with nine tine arms, these rakes feature a 10'6" (3.2 m) working width.



CV PTO

For maximum maneuverability without PTO chatter, the GA 3200 GT is fitted with a CV PTO as standard equipment. This allows the tightest turns in field corners without the worry of driveline chatter and wear.



ADJUSTABLE WINDROW CURTAIN

The windrow width can be varied to match your crop conditions by moving the curtain in and out. The curtain height and the front-to-rear positioning can also be adjusted to meet your specific needs.

GA 3200 GT – straight horizontal adjustment (shown above)
GA 3201 GM – parallelogram adjustment



SIMPLE HEIGHT ADJUSTMENT

For optimum raking, the tines should be set as low as needed to cleanly rake the crop without touching the ground. As stubble height varies, the height of the tines can also be adjusted.

(GA 3200 GT only)

MEETING THE CHALLENGE OF VARYING FIELD CONDITIONS

When your operation requires a larger raking width, a heavy-duty design is critical for reliable performance and long service life. KUHN rotary rakes meet this challenge with the exclusive Masterdrive® gearbox for all single-rotor models above a 13' (4 m) working width.

ULTIMATE PRODUCTIVITY

These mounted rotary rakes feature three important advantages — larger working widths, faster working speeds and increased maneuverability for outstanding productivity.



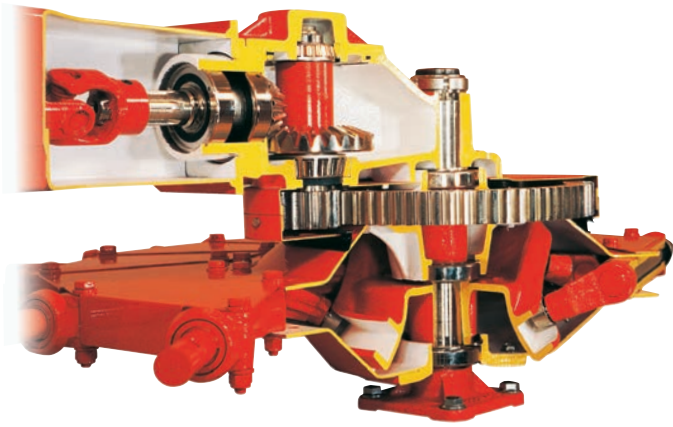

MASTERDRIVE®

The KUHN exclusive Masterdrive® double-reduction gearbox is designed for all types of crops, larger rotors, and demanding conditions. The fully enclosed Masterdrive double-reduction gearbox incorporates a two-stage reduction drive for increased durability and reliability with a longer service life and lower power requirement. The large gears and gear teeth are meshed together with tight clearances to minimize wear and provide the best overall power transmission for maximum efficiency.

CONSISTENT RAKING QUALITY

The right guard and windrow deflector can be easily raised and lowered with the assistance of the convenient spring design.

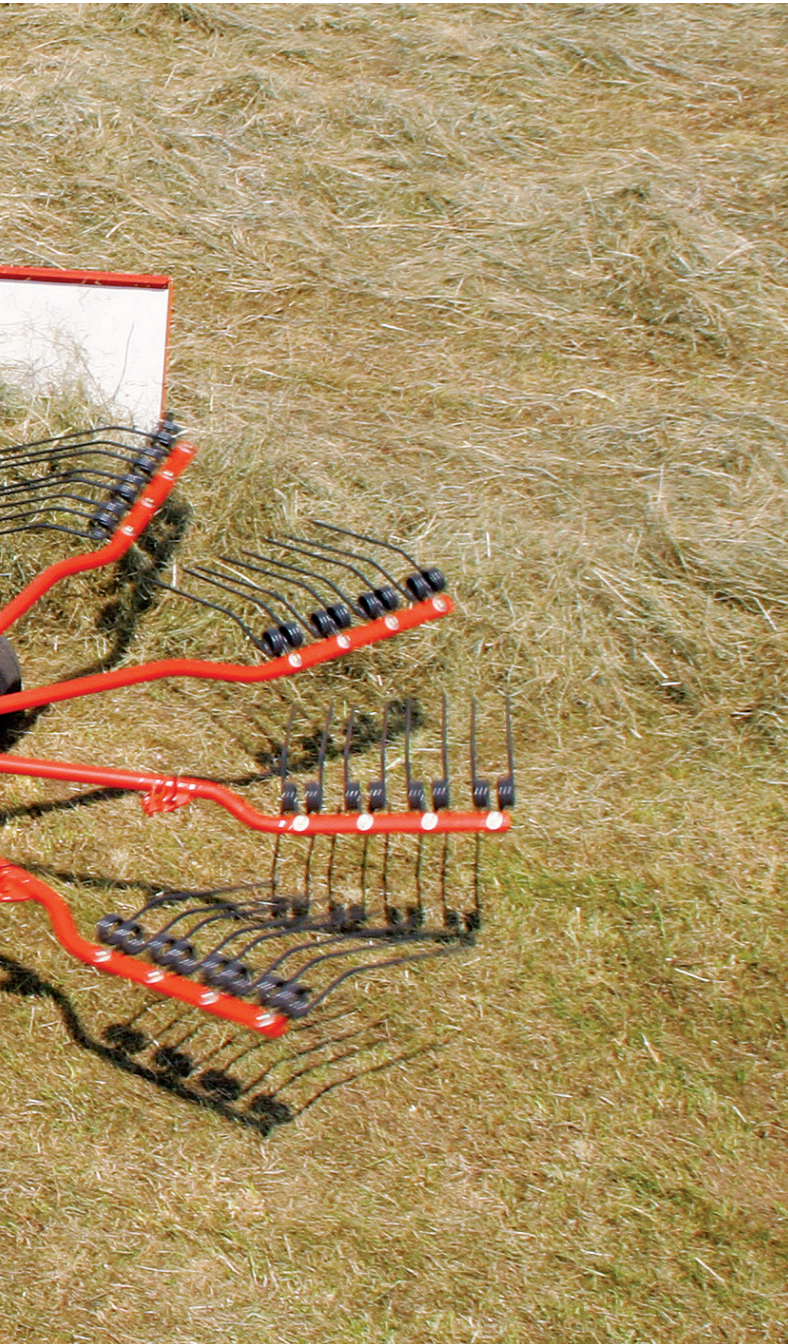

OUTSTANDING RAKING PERFORMANCE

The greater number of tine arms allows you to work at higher speeds while maintaining a slower rotor speed. This helps ensure that the crop is raked both cleanly and gently. The double-curved tine arm design increases capacity and enables optimum raking quality. The result is well-formed, airy windrows that decrease drying time and improve harvest efficiency.



RIGHT-HAND DELIVERY

For maximum operator efficiency and comfort, right-hand delivery is ideal. All KUHN single-rotor rakes above a 13' (4 m) working width feature right-hand delivery as standard due to the double-reduction gearbox. You can monitor raking quality and make adjustments at the same time with both the windrow and tractor controls conveniently located on your right side.



ROTARY RAKES GA 4230 T / 4231 T



THE RAKE YOU LOVE WITH ADDED RELIABILITY AND DURABILITY

With a working width of 13'10" (4.2 m), the KUHN GA 4230 T and GA 4231 T single-rotor rotary rakes build on the popularity of the prior generation of KUHN's single-rotor rakes. The Masterdrive® GIII double-reduction gearbox has been incorporated into these models. The gearbox features the KUHN exclusive double reduction drive that not only provides the ergonomic benefits of right-hand swath delivery, but also improves the power flow through the gearbox. These new models have a lighter, but stronger construction with aluminum rake arm housings, large cam bearings and a cam track designed to reduce peak loads. They maintain the KUHN double bend tine arms that offer clean raking and excellent capacity for consistent, fluffy windrows.



NARROW TRANSPORT WIDTH

Road transport can be accomplished with complete peace of mind — simply store the tine arms in the convenient rack at the front of the machine and fold up the guards vertically. Lighting and turn signals can also be added for additional visibility when traveling on the road. Lights are optional.

(Tine arm removal not possible on GA 4230 T)

HYDRAULIC LIFT AND HEIGHT CRANK

The GA 4230 T and GA 4231 T come with a standard hydraulic raise/lower function for headland turning. The working height stop is adjusted by a simple hand crank, making any adjustments to field conditions quick and easy. A cylinder on the tongue ensures the rake lowers its rear first similar to a plane touching down, this ensures the tines do not contact the ground when raking.

PERFECT GROUND FOLLOWING

Equipped with standard bogie axles, GA trailed rotary rakes are designed to handle uneven ground. They smooth out bumps and holes keeping the distance between the ground and tines constant. The close positioning of the wheels to the tines provides smooth operation. The ultimate benefit is high-quality forage and no crop loss, while working at higher speeds without sacrificing stability.

INCREASE YOUR OPERATION'S PRODUCTIVITY

The trailed KUHN GA 4731 T and 5031 T rotary rakes with working widths of 15'3" (4.6 m) and 16'4" (5.0 m) were designed for operators looking to increase their productivity. These rakes are fit with rotors featuring KUHN's patented Masterdrive® GIII double-reduction gearbox that has been tested in the heaviest of forages.





EXTREMELY USER FRIENDLY

With some rakes, switching between field and road transport can be tedious. The GA 4731 T and 5031 T have been designed to include larger arm holders and a centralized locking system for maximum efficiency in and out of the field. The optional hydraulic folding windrow curtain and guard makes the transition from working position to transport quick and easy.



HIGH GROUND CLEARANCE

When raised in the headland position, there is 24" (61 cm) of clearance between the tines and ground to pass over previously made windrows without disturbing them.



MASTERDRIVE® GIII ROTOR PROVIDES GREATER RELIABILITY

The patented KUHN Masterdrive GIII double-reduction gearbox is designed for heavy crops, tough field conditions, and intensive use. Key components have been improved to build lighter, yet stronger rotors such as: aluminum alloy housings, optimized cam track minimizing force on the follower bearing, larger follower bearing diameter reducing rotation speed and pressure on the cam, tine arms with large-dimension bearings, sturdier pivoting tine support shaft, reinforced main shaft, and reinforced mounting of tine arms on tine holders. The Masterdrive GIII's ability to move heavy wet crop, handle dry hay gently, and neatly windrow corn stalks is unrivaled in the industry.



ROTARY RAKES GA 4731 T / 5031 T

EXCEPTIONAL WINDROW FORMATION IN A MATTER OF MINUTES

Get in and out of the field faster with these trailed, single-rotor rakes as they make an excellent windrow in a matter of minutes. These rakes create well-formed, light and fluffy windrows that allow air to pass through the entire windrow leading to an even and consistent drydown.



EASILY ADJUST THE WORKING HEIGHT

The adjustment setting for working height **(1)** and rotor leveling **(2)** is extremely easy to do with the crank handle on the machine. With this feature, you can precisely set the raking height in order to maximize the crop pickup while minimizing the collection of foreign material.



STABILITY IN HILLY CONDITIONS

When in hilly conditions, the GA 4731 T and GA 5031 T have solid stability with tandem axles and the added benefit of having cushioned suspension thanks to a shock absorber on the machine. Ground following is also ideal because of the proximity of the tandem axles and the wheels to the tines, keeping them engaged in the hay and off the ground.



SIMPLE OPERATION

With a low horsepower requirement, an easy folding windrow curtain, and one single-acting hydraulic valve to raise and lower the machine, these rakes are extremely easy to operate.



MAKE WINDROWS WITH EASE

Set the desired windrow width with the easily adjustable windrow curtain to match up to any piece of harvesting equipment being used. Let the tines and tine arms do the rest by gathering the crop and placing it in a well-formed, light and fluffy windrow.



Customized to Fit Your Operation

OPTIONAL EQUIPMENT



HYDRAULIC FOLDING GUARDS AND WINDROW WIDTH ADJUSTMENT

Select models (see specifications page) feature optional hydraulic control of the folding guards (1) as well as the windrow width (2) from the comfort of the tractor seat.



ADDED SUPPORT FOR SUPERIOR GROUND FOLLOWING

All mounted KUHN rotary rakes can be fitted with an additional prop wheel at the front of the rotor. This additional wheel provides improved raking performance and enhanced following of changing ground contours.



SMOOTHER RAKING

GA 4321 GM mounted models are available with an optional second dampener. This will allow these models to run more smoothly over bumpy ground and hilly fields.

Model Specifications

MOUNTED ROTARY RAKES	GA 300 GM	GA 3201 GM	GA 4121 GM	GA 4321 GM
Hitch Type	3-Point – Cat 1 and 2	3-Point – Cat 1 and 2	3-Point – Cat 1 and 2	3-Point – Cat 2
Number of Tine Arms	9	9	10	12
Number of Tines Per Arm	3	3	4	4
Removable Tine Arms	–	Standard	Standard	Standard
Foldable Safety Guards	–	Standard	Standard	Standard
Transport Width (Arms Removed)	–	5'9" (1.8 m)	5'8" (1.7 m)	6'4" (2 m)
Working Width (Including Windrow)	10'6" (3.2 m)	10'6" (3.2 m)	13'5" (4.1 m)	13'9" (4.2 m)
Approximate Windrow Width	2'7"–3'11" (0.8 m–1.2 m)	2'7"–3'11" (0.8 m–1.2 m)	4'3" (1.3 m)	4'3" (1.3 m)
Clean Swept Width	7'3" (2.2 m)	7'3" (2.2 m)	9'2" (2.8 m)	9'7" (2.9 m)
Rotor Diameter	8'8" (2.7 m)	8'8" (2.7 m)	10'6" (3.2 m)	11'1" (3.6 m)
Dampener	–	–	Optional	Optional
Hydraulic Rotor Lift	–	–	–	–
Fully Enclosed Gearbox	Enclosed gearbox	Enclosed gearbox	Masterdrive® Gll gearbox	Masterdrive® Gll gearbox
PTO Speed	540 RPM	540 RPM	540 RPM	540 RPM
Minimum PTO Power Requirement	20 hp (15 kW)	20 hp (15 kW)	30 hp (22 kW)	30 hp (22 kW)
Tandem Axle	Optional	Optional	Optional	Standard
Prop Wheel	Optional	Optional	Optional	Optional
Tires	15 x 6–6	15 x 6–6	16 x 6.5–8	16 x 6.5
Road Lights and Signaling	Optional	Optional	Optional	Optional
Machine Net Weight	631 lbs (286 kg)	820 lbs (372 kg)	1,190 lbs (540 kg)	1,547 lbs (702 kg)

TRAILED ROTARY RAKES	GA 3200 GT	GA 4230 T	GA 4231 T	GA 4731 T	GA 5031 T
Hitch Type	Drawbar	Drawbar	Drawbar	Drawbar	Drawbar
Number of Tine Arms	9	11	11	13	15
Number of Tines Per Arm	3	4	4	4	4
Removable Tine Arms	–	–	Standard	Standard	Standard
Foldable Safety Guards	–	–	Standard	Standard	Standard
Transport Width (Arms Removed)	–	–	6'5" (2.0 m)	7'7" (2.3 m)	7'7" (2.3 m)
Working Width (Including Windrow)	10'6" (3.2 m)	13'10" (4.2 m)	13'10" (4.2 m)	15'3" (4.6 m)	16'5" (5.0 m)
Approximate Windrow Width	2'7"–3'11" (0.8 m–1.2 m)	4'3" (1.3 m)	4'3" (1.3 m)	2'4"–4'11" (0.7–1.5 m)	2'4"–4'11" (0.7–1.5 m)
Clean Swept Width	7'3" (2.2 m)	9'2" (2.8 m)	9'2" (2.8 m)	11' (3.4 m)	12' (3.7 m)
Rotor Diameter	8'8" (2.7 m)	10'6" (3.2 m)	10'6" (3.2 m)	12' (3.7 m)	13' (4 m)
Hydraulic Rotor Lift	Mechanical	Standard	Standard	Standard	Standard
Fully Enclosed Gearbox	Enclosed gearbox	Masterdrive® Glll gearbox	Masterdrive® Glll gearbox	Masterdrive® Glll gearbox	Masterdrive® Glll gearbox
Wide Angle PTO Shaft	Standard	Standard	Standard	Standard	Standard
PTO Speed	540 RPM	540 RPM	540 RPM	540 RPM	540 RPM
Minimum PTO Power Requirement	20 hp (15 kW)	30 hp (22 kW)	30 hp (22 kW)	35 hp (26 kW)	40 hp (30 kW)
Safety Chains	Standard	Standard	Standard	Standard	Standard
Tandem Axle	Optional	Standard	Standard	Standard	Standard
Tires	18 x 8.5–8	18 x 8.5-8	18 x 8.5-8	18 x 8.5–8	18 x 8.5–8
Road Lights and Signaling	Optional	Optional	Optional	Standard	Standard
Machine Net Weight	661 lbs (300 kg)	1,257 lbs (570 kg)	1,316 lb (597 kg)	2,330 lbs (1,057 kg)	2,630 lbs (1,193 kg)

*Tines arms cannot be removed on the GA 3200 GT and GA 4230 T.



COMPLEMENTARY PRODUCTS

MORE PRODUCTS TO MEET YOUR NEEDS

With over 700 models of equipment, we have the most complete implement line in the industry. Whether you have a small or large operation, we have a broad range of models and options to help fit your diverse needs.



1. Mowers
2. Mower Conditioners
3. Tedders
4. Round Balers
5. Bale Processors
6. TMR Mixers

MyKUHN

THE LINK TO MY SUCCESS

www.mykuhn.com

For more information about your nearest KUHN dealer and other KUHN products, visit our website at www.kuhn.com



Visit our YouTube channel to watch our latest product videos.



Your KUHN dealer

KUHN NORTH AMERICA, INC.
 Corporate Headquarters
 1501 West Seventh Avenue - Brodhead, WI 53520

Information given in this document is only for informational purposes and is non-contractual. Our machines are in compliance with North American safety standards. In our literature, and for improved illustration of certain details, some safety devices may not be in operating position. When operating these machines, these devices must be operated in accordance with the requirements indicated in the operator's manuals and assembly manuals. We reserve the right to change any designs, specifications or materials listed without further notice. Machines and equipment in this document can be covered by at least one patent and/or registered design. Trademarks cited in this document may be registered in one or several countries.

Find us on