

Robex

# 140w-9A

With Tier 4 Interim Engine installed

**HYUNDAI HEAVY INDUSTRIES**

MOVING YOU FURTHER



Photo may include optional equipment



**HYUNDAI**  
CONSTRUCTION EQUIPMENT AMERICAS, INC.

# PRIDE AT WORK

Hyundai Heavy Industries strives to build state-of-the-art earthmoving equipment to give every operator maximum performance, more precision, versatile machine preferences, and proven quality.

*Take pride in your work with Hyundai!*



# Robex 140w-9A

## Machine Walk-Around



\*Photo may include optional equipment

### Engine Technology

Proven, reliable, fuel efficient, low emission and low noise  
Cummins Tier 4 interim & EU stage III B engine

### Hydraulic System Improvements

New patented hydraulic control for improved controllability / Improved control valve design for added efficiency and smoother operation / New auto boom and swing priority system for optimum speed / New auto power boost feature for additional power when needed / Improved arm-in and boom-down flow regeneration system for added speed and efficiency

### Pump Compartment

Industry-leading, powerful, reliable Kawasaki designed, variable volume in-line axial piston pumps  
New compact solenoid block equipped with 3 solenoid valves, 1 EPPR valve, 1 check valve accumulator and pilot filter - controls 2 speed travel, power boost, boom priority, safety lock

### Enhanced Operator Cab

#### Improved Visibility

Enlarged cab with improved visibility / See-through upper skylight for visibility and ventilation  
Larger right-side glass, now one piece, for better right visibility  
Safety glass windows on all sides - less expensive than (polycarbonate) and won't scratch or fade  
Closeable sunshade for operator convenience / Reduced front window seam for improved operator view

#### Improved Cab Construction

New steel tube construction for added operator safety, protection and durability  
New window open/close mechanism designed with cable and spring lift assist and single latch release

#### Improved Suspension Seat / Console Assembly

Ergonomic joysticks with auxiliary control buttons for attachment use. Now with new sleek styling  
Heated suspension (option) or air ride suspension (standard) with heat  
New joystick consoles - now adjustable in height by pushing the button  
Integrated seat with consoles - reduce the operator fatigue

#### Advanced 7" Color Cluster with Touch Screen

New Color LCD Display with easy to read digital gauges for hydraulic oil temperature, water temperature, and fuel. Simplified design makes adjustment and diagnostics easier. Also, new enhanced features such as rear-view camera are integrated into monitor.

3 power modes : (P) Power, (S) Standard, (E) Economy, 2 work modes : Dig & Attachment, (U) User mode for operator preference

Enhanced self-diagnostic features with GPS download capability

One pump flow or two pump flow for optional attachment is now selectable through the cluster / New anti-theft system with password capability

Boom speed and arm regeneration are selectable through the monitor.

Auto power boost is now available - selectable (on/off) through the monitor.

Powerful air conditioning and heat with auto climate control

RMS (Remote Management System) works through GPS/satellite technology to ultimately provide better customer service and support.

### Improved Steering Column

Slim-profile steering column capable of telescoping 60 mm and tilting 30 degrees

# PRECISION

Innovative hydraulic system technologies make the 9A series excavator fast, smooth and easy to control.



\*Photo may include optional equipment.

# Computer Aided Power

The engine horsepower and hydraulic horsepower together in unison through the advanced CAPO(Computer Aided Power Optimization) system, flow for the job at hand. Operator can set their own preferences for boom or swing priority, power mode selection and optional work tools at the touch of a button.

The CAPO system also provides complete self diagnostic features and digital gauges for important information like hydraulic oil temperature, water temperatures and fuel level. This system interfaces with multiple sensors placed throughout the hydraulic system as well as the electronically controlled engine to provide the optimum level of engine power and hydraulic flow.

## Power Mode

P (Power Max) mode maximizes machine speed and power for mass production. S (Standard) mode provides a reduced, fixed rpm for optimum performance and improved fuel economy. For maximum fuel savings and improved control, E (Economy) mode provides precise flow and engine power based on load demand. Three unique power modes provide the operator with custom power, speed and fuel economy.

## Work Mode

The work mode allows the operator to select single flow attachments like a hydraulic breaker or bi-directional flow attachments like a crusher. Flow settings unique to each attachment can be programmed from within the cluster.

## User Mode

Some jobs require more precise machine settings. Using the versatile U (User) mode, the operator can customize engine speed, pump output, idle speed and other machine settings for the job at hand.

# Improved Hydraulic System



To achieve optimum precision, Hyundai redesigned the hydraulic system to provide the operator with super fine touch and improved controllability. Improved pump flow control reduces flow when controls are not being used to minimize fuel consumption.

Improved spool valves in the control valve are engineered to provide more precise flow to each function with less effort.

Improved hydraulic valves, precision-designed variable volume piston pumps, fine-touch pilot controls, and enhanced travel functions make any operator running a 9A series look like a smooth operator. Newly improved

features include arm-in and boom-down flow regeneration, improved control valve technology and innovative auto boom and swing priority for optimal performance in any application.

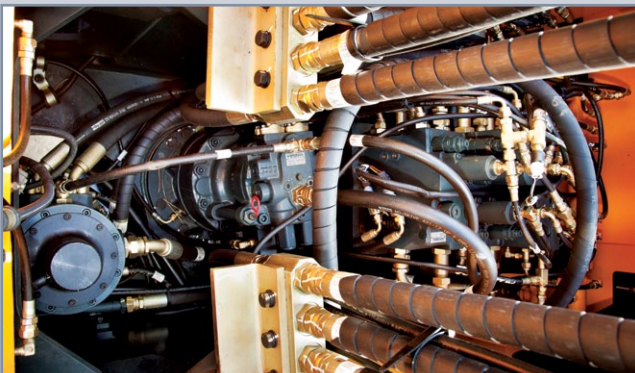

## Auto Boom-swing Priority

This smart function automatically and continuously looks the ideal hydraulic flow balance for the boom and swing motions of the machine. The advanced CAPO system monitors the hydraulic system and adjusts its settings to maximize performance and productivity.

# PERFORMANCE

9A series is designed for maximum performance to keep the operator working productively.



\*Photo may include optional equipment.

## Fully Independent Outrigger System

R140W-9A can be equipped with four independent outriggers (front and rear) or two independent outriggers and a dozer blade (front or rear). Each outrigger and the dozer blade are controlled by a switch and the dozer lever. Each outrigger is equipped with cylinder guards for added protection.

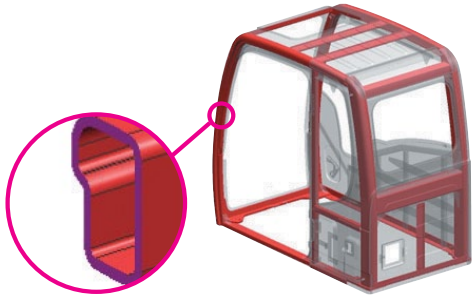

## Structure Strength

The 9A series cabin structure has been fitted with stronger but slimmer tubing for more safety and improved visibility. Low-stress, high strength steel is integrally welded to form a stronger, more durable upper and lower frame. Structural integrity was tested by way of FEM (Finite Elements Method) analysis and long-term durability tests. The optional ROPS(Roll Over Protective Structure) cab can be equipped to enhance operator safety.

## New and Improved Travel System

Auto cruise control system reduces operator fatigue by maintaining a fixed speed when driving distances. A new auto ram lock system is available to improve operating safety. A new creep speed travel system improves maneuverability and fine control. A new optional forward / reverse travel pedal control allows operators to choose to use the travel pedal control while in work mode or lever control when in travel mode.

## CUMMINS QSB 6.7 Engine

The Tier IV, six cylinder, 4 cycle, turbo-charged, charge air cooled, Cummins QSB 6.7 engine provides maximum power, reliability, optimum fuel economy, and reduced emissions. Electronically controlled fuel injection and diagnostic capabilities add to the engines efficiency and serviceability.



# PREFERENCE

Operating a 9A series is unique to every operator. Operators can fully customize their work environment and operating preferences to fit their individual needs.



\*Photo may include optional equipment.

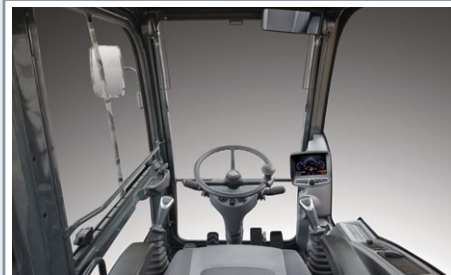

## Wide Cabin with Excellent Visibility

The newly designed cabin was conceived for more space, a wider field of view and operator comfort. Special attention was given to a clear, open and convenient interior with plenty of visibility on the machine surroundings and the job at hand. This well balanced combination of precision aspects put the operator in the perfect position to work safely and securely.



## Operator Comfort

In 9A series cabin you can easily adjust the seat, console and armrest settings to best suit your comfort level. The seat integrated with console absorb console vibration by seat suspension and reduce operator's fatigue. New joystick consoles are adjustable in height by pushing the button. Other preference settings that add to overall operator comfort include the fully automatic high capacity airconditioning system, transparent polycarbonate glass sun roof, large and easy to control sun visor, and the Radio / USB player.



## Reduced Stress

Work is stressful enough. Your work environment should be stress free. Hyundai's 9A series provides improved cab amenities, additional space and a comfortable seat to minimize stress to the operator. A powerful climate control system provides the operator with optimum air temperature. An advanced audio system with USB player, AM/FM stereo and MP3 capabilities, plus remotely located controls is perfect for listening to music favorites. Operators can even talk on the phone with the hands-free cell phone feature. Also, the newly designed optional remote control offers mobile bluetooth-handsfree and radio cable-handsfree function.



## Smart Key System (Option)

User authentication and anti-theft system are reinforced with smart key system. This allows the operator to start the engine with the push of a starter button rather than inserting a key into the ignition.



## Operator - Friendly Cluster

The advanced new cluster with 7 inch wide color LCD with touch screen and toggle switch allows the operator to select his personal machine preferences. Power and work mode selection, self diagnostics, optional rear-view camera, maintenance check lists, start-up machine security, and video functions were integrated into the cluster to make the machine more versatile and the operator more productive.

The newly applied FM transmitter application transmits signal to USB & Radio player with the same frequency as cluster. The player outputs the audio through the internal speaker in the cab. The video & firmware updates are possible with USB host support and an adjustable cluster hinge bracket improves cluster visibility.

### Monitor Tilt Range



# PROFITABILITY

9A series is designed to maximize profitability through improved efficiencies, enhanced service features and longer life components.



\*Photo may include optional equipment.



## Hi-mate (Remote Management System)

Hi-mate, Hyundai's proprietary remote management system, provides operators and dealer service personnel access to vital service and diagnostic information on the machine from any computer with internet access. Users can pinpoint machine location using digital mapping and set machine work boundaries, reducing the need for multiple service calls. Hi-mate saves time and money for the owner and dealer by promoting preventative maintenance and reducing machine downtime.

## Fuel Efficiency

9A series excavators are engineered to be extremely fuel efficient. New innovations like the variable speed fan clutch, two-stage auto decel system and the new economy mode help to conserve fuel and reduce the impact on the environment.

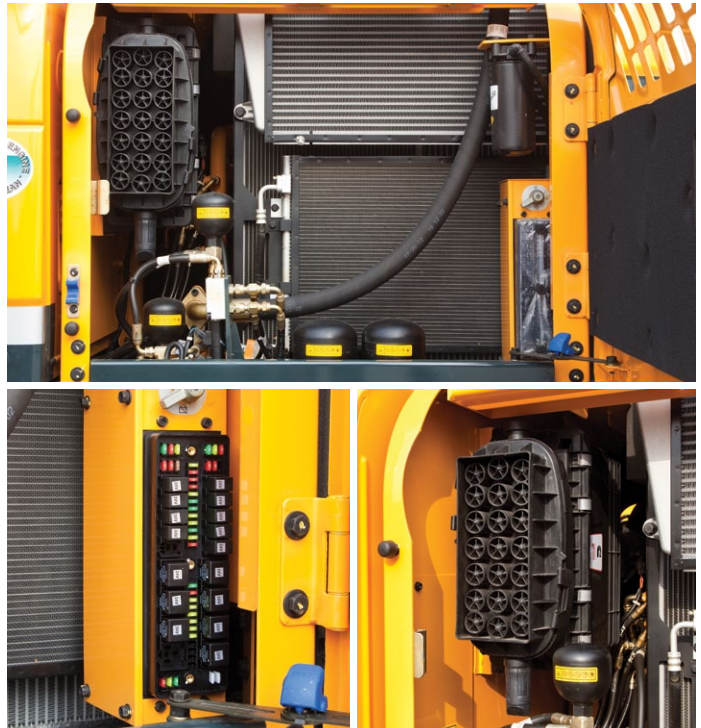

## Easy Access

Ground-line access to filters, lube fittings, fuses, machine computer components and wide open compartments makes service more convenient on the 9A series.



## Long-Life Components

9A series excavators were designed with bushings designed for long-life lube intervals (250 hrs) & polymer shims (wear resistant, noise reducing), long-life hydraulic filters (1,000hrs), long-life hydraulic oil (5,000hrs), more efficient cooling systems and integrated preheating systems which extend service intervals, minimize operating costs and reduce machine down time.

# Specifications

## ENGINE

MODEL		Cummins QSB 6.7	
Type		Water-cooled, 4-cycle diesel, 6-cylinder in-line, Direct injection, Turbocharged, Charge air cooled, Low emission	
Rated flywheel horsepower	SAE	J1995 (gross)	146 HP (109kW) at 2,100 rpm
		J1349 (net)	136 HP (101kW) at 2,100 rpm
	DIN	6271/1 (gross)	148 PS (109kW) at 2,100 rpm
		6271/1 (net)	138 PS (101kW) at 2,100 rpm
Max. torque		74.7 kgf·m(540 lbf·ft) at 1,500 rpm	
Bore X stroke		107 x 124 mm (4.21" x 4.88")	
Piston displacement		6,700 cc (409 in <sup>3</sup> )	
Batteries		2 x 12 V x 100 AH	
Starting motor		24V-4.8kW	
Alternator		24V-95 Amp	

## HYDRAULIC SYSTEM

MAIN PUMP	
Type	Two variable displacement piston pumps
Rated flow	2 X 172 L/min (45.4 US gpm/37.8 UK gpm)
Sub-pump for pilot circuit	Gear pump

Cross-sensing and fuel saving pump system

## HYDRAULIC MOTORS

Travel	Bent - axis pistons motor with brake valve and parking brake
Swing	Axial piston motor with automatic brake

## RELIEF VALVE SETTING

Implement circuits	350 kgf/cm <sup>2</sup> (4,970 psi)
Travel	380 kgf/cm <sup>2</sup> (5,400 psi)
Power boost (boom, arm, bucket)	380 kgf/cm <sup>2</sup> (5,400 psi)
Swing circuit	285 kgf/cm <sup>2</sup> (4,050 psi)
Pilot circuit	40 kgf/cm <sup>2</sup> (570 psi)
Service valve	Installed

## HYDRAULIC CYLINDERS

No. of cylinder bore X stroke	Boom : 2-105 x 1075 mm (4.1" x 42.3")
	Arm : 1-115 x 1138 mm (4.5" x 46.8")
	Bucket : 1-100 x 840 mm (3.9" x 33.1")
	Blade : 2-100 x 236 mm (3.9" x 9.3")
	Outrigger : 2-110 x 446 mm (4.9" x 18.7")
	2-PCS boom : 2-105 x 975mm (4.1" x 38.4") Adjust(boom) : 1-145 x 613mm (5.7" x 24.1")

## DRIVES & BRAKES

4-wheel hydrostatic drive. Constant mesh, helical gear transmission provides 2 forward and reverse travel speeds.

Max. drawbar pull	8,500 kgf (18,740 lbf)	
Travel speed	1st	10 km/h
	2nd	39 km/h
Gradeability	35(70 %)	

Parking brake : Independent dual brake, front and rear axle full hydraulic power brake.

- Spring released and hydraulic applied wet type multiple disk brake.
- Transmission is locked at neutral position for parking, automatically.

## CONTROL

Pilot pressure operated joysticks and pedals with detachable lever provide almost effortless and fatiguelless operation.

Pilot control	Two joysticks with one safety lever (LH): Swing and arm, (RH): Boom and bucket (ISO)
Engine throttle	Electric, Dial type
Lights	Two lights mounted on the boom, one under the battery box and one under the cabin

## AXLE & WHEEL

Full floating front axle is supported by center pin for oscillation. It can be locked by oscillation lock cylinders. Rear axle is fixed on the lower chassis.

Tires	9.00-20-14PR, Dual(tube type)
(optional)	9.00-20, Dual(solid type)
	10.00-20-14PR, Dual(tube type)

## SWING SYSTEM

Swing motor	Fixed displacement axial pistons motor
Swing reduction	Planetary gear reduction
Swing bearing lubrication	Grease-bathed
Swing brake(option)	Multi wet disc
Swing speed	11.7 rpm

## STEERING SYSTEM

Hydraulically actuated, orbitrol type steering system actuates on front wheels through the steering cylinders.

Min. turning radius	6,300 mm(20' 8")
---------------------	------------------

## COOLANT & LUBRICANT CAPACITY

	liter	US gal	UK gal	
Re-filling				
Fuel tank	270	71.3	59.4	
Engine coolant	19.5	5.2	4.3	
Engine oil	23.7	6.3	5.2	
Swing device - gear oil	2.5	0.7	0.5	
Axle	Front	13.8	3.65	3.04
	Rear	16.1	4.3	3.5
Hydraulic system (including tank)	210	55.5	46.2	
Hydraulic tank	124	32.8	27.3	

## UNDERCARRIAGE

Reinforced box-section frame is all-welded, low-stress.

Dozer blade and outriggers are available. A pin-on design.

Dozer blade	A very useful addition for leveling and back filling or clean-up work.
Outrigger	Indicated for max. operation stability when digging and lifting. Can be mounted on the front/or the rear.

## OPERATING WEIGHT (APPROXIMATE)

Operating weight, including 4,600mm (15' 1") One-piece boom, 2,100mm (6' 11") arm, SAE heaped 0.58 m<sup>3</sup> (0.76 yd<sup>3</sup>) backhoe bucket, lubricant, coolant, full fuel tank, hydraulic tank and the standard equipment.

## MAJOR COMPONENT WEIGHT

Upperstructure	4,680kg (10,320 lb)
Mono boom(with arm cylinder)	1,030kg (2,270 lb)
Hydraulic adjustable boom (with adjust cylinder and arm cylinder)	1,430kg (3,150 lb)

## OPERATING WEIGHT

	Mono boom	Hyd. adjustable boom
Undercarriage		
Rear dozer blade	13,700 (30,200)	14,100 (31,090)
Rear outrigger	14,100 (31,090)	14,500 (31,970)
Front outrigger and rear blade	14,700 (32,410)	15,100 (33,290)
Front blade and rear outrigger	14,700 (32,410)	15,100 (33,290)
Four outrigger	15,100 (33,290)	15,500 (34,170)

## BUCKETS

All buckets are welded with high-strength steel.



0.23 (0.30)

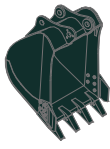

0.40 (0.52)  
0.46 (0.60)

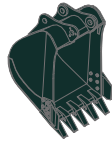

0.52 (0.68)  
0.58 (0.76)



0.65 (0.85)

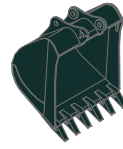

0.71 (0.93)

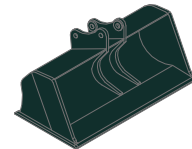

0.45 (0.59)



0.55 (0.72)

SAE heaped m<sup>3</sup> (yd<sup>3</sup>)

Capacity m <sup>3</sup> (yd <sup>3</sup> )		Width mm (in)		Weight kg (lb)	Recommendation m (ft-in)						
SAE heaped	CECE heaped	Without sidecutters	With sidecutters		4.6 (15' 1") Boom				4.9 (16' 1") Boom		
					1.9 (6' 3") Arm	2.1 (6' 11") Arm	2.5 (8' 2") Arm	3.0 (9' 10") Arm	1.9 (6' 3") Arm	2.1 (6' 11") Arm	2.5 (8' 2") Arm
0.23 (0.30)	0.20(0.26)	520(20.5)	620(24.4)	335(740)	●	●	●	●	●	●	●
0.40 (0.52)	0.35(0.46)	750(29.5)	850(33.5)	410(900)	●	●	●	●	●	●	●
0.46 (0.60)	0.40(0.52)	840(33.1)	940(37.0)	435(960)	●	●	●	■	●	●	■
0.52 (0.68)	0.45(0.59)	915(36.0)	1,015(40.0)	460(1,010)	●	●	■	▲	●	■	■
0.58 (0.76)	0.50(0.65)	1,000(39.4)	1,100(43.3)	480(1,060)	●	■	■	▲	■	▲	▲
0.65 (0.85)	0.55(0.72)	1,105(43.5)	1,205(47.4)	500(1,100)	■	▲	▲	-	▲	▲	-
0.71 (0.93)	0.60(0.78)	1,190(46.9)	1,290(50.8)	540(1,190)	▲	▲	-	-	▲	-	-
0.45 (0.59)	0.40(0.52)	1,520(59.8)	1,620(63.8)	410(900)	●	●	■	-	■	■	▲
0.55 (0.72)	0.45(0.59)	1,800(70.9)	1,900(74.8)	585(1,290)	■	▲	▲	-	■	▲	▲

- Ditching bucket
- Slope finishing bucket

- : Applicable for materials with density of 2,000 kg /m<sup>3</sup> (3,370 lb/ yd<sup>3</sup>) or less
- : Applicable for materials with density of 1,600 kg /m<sup>3</sup> (2,700 lb/ yd<sup>3</sup>) or less
- ▲: Applicable for materials with density of 1,100 kg /m<sup>3</sup> (1,850 lb/ yd<sup>3</sup>) or less

## ATTACHMENT

Booms and arms are welded with a low-stress, full-box section design. 4.6m & 4.9m Booms and 1.9m, 2.1m, 2.5m, & 3.0m Arms are available.

## DIGGING FORCE

Boom	Length	mm (ft-in)	4,600 (15' 1")				Remarks
	Weight	kg (lb)	1,030 (2,270)				
Arm	Length	mm (ft-in)	1,900 (6' 3")	2,100 (6' 11")	2,500 (8' 2")	3,000 (9' 10")	[ ]: Power Boost
	Weight	kg (lb)	560 (1,230)	580 (1,280)	610 (1,340)	670 (1,480)	
Bucket digging force	SAE	kN	87.3 [94.8]	87.3 [94.8]	87.3 [94.8]	87.3 [94.8]	
		kgf	8,900 [9,660]	8,900 [9,660]	8,900 [9,660]	8,900 [9,660]	
		lbf	19,620 [21,300]	19,620 [21,300]	19,620 [21,300]	19,620 [21,300]	
	ISO	kN	102 [110.8]	102 [110.8]	102 [110.8]	102 [110.8]	
		kgf	10,400 [11,290]	10,400 [11,290]	10,400 [11,290]	10,400 [11,290]	
		lbf	22,930 [24,890]	22,930 [24,890]	22,930 [24,890]	22,930 [24,890]	
Arm crowd force	SAE	kN	76.5 [83.1]	73.6 [79.9]	62.8 [68.2]	55.9 [60.7]	
		kgf	7,800 [8,470]	7,500 [8,140]	6,400 [6,950]	5,700 [6,190]	
		lbf	17,200 [18,670]	16,530 [17,950]	14,110 [15,320]	12,570 [13,640]	
	ISO	kN	80.4 [87.3]	77.5 [84.1]	65.7 [71.4]	57.9 [62.8]	
		kgf	8,200 [8,900]	7,900 [8,580]	6,700 [7,270]	5,900 [6,410]	
		lbf	18,080 [19,630]	17,420 [18,910]	14,770 [16,040]	13,010 [14,120]	

Note: Boom weight includes arm cylinder, piping, and pin

Arm weight includes bucket cylinder, linkage, and pin

# Dimensions & Working Range

## R140W-9A DIMENSIONS

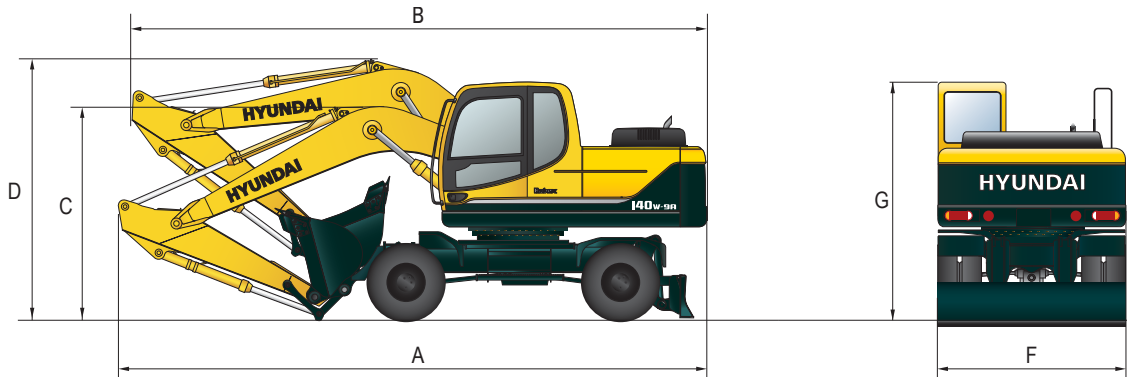

Unit : mm (ft · in)

Mono Boom	4,600(15' 1")			
Arm	1,900 (6' 3")	2,100 (6' 11")	2,500 (8' 2")	3,000 (9' 10")
A Overall length of shipping position	7,760 (25' 6")	7,820 (25' 8")	7,770 (25' 6")	7,830 (25' 8")
B Overall length of traveling position	7,750 (25' 5")	7,760 (25' 6")	7,690 (25' 3")	7,710 (25' 4")
C Height of attachment(shipping position)	2,760 (9' 1")	2,860 (9' 5")	2,810 (9' 3")	3,100 (10' 2")
D Height of attachment(traveling position)	3,500 (11' 6")	3,500 (11' 6")	3,620 (11' 11")	3,600 (11' 10")
F Overall width	2,500 (8' 2")	2,500 (8' 2")	2,500 (8' 2")	2,500 (8' 2")
G Height of cabin	3,140 (10' 4")	3,140 (10' 4")	3,140 (10' 4")	3,140 (10' 4")

## R140W-9A WORKING RANGE

Unit : mm (ft · in)

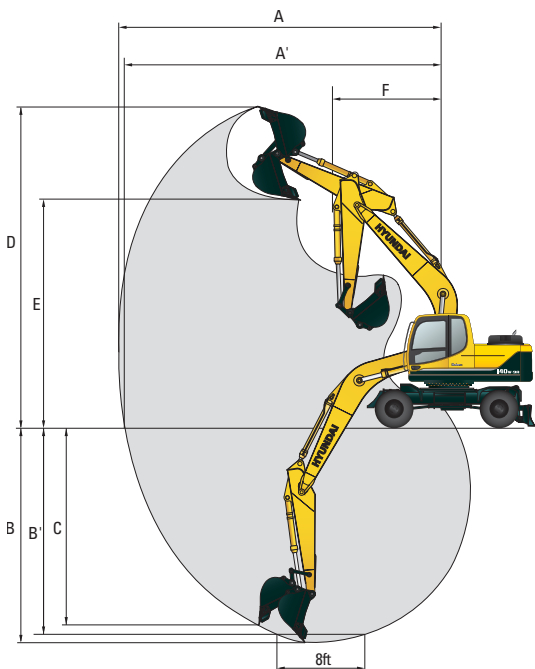

Boom length	4,600 (15' 1")			
Arm length	1,900 (6' 3")	2,100 (6' 11")	2,500 (8' 2")	3,000 (9' 10")
A Max. digging reach	7,750 (25' 5")	7,920 (26' 0")	8,320 (27' 4")	8,780 (28' 10")
A' Max. digging reach on ground	7,530 (24' 8")	7,700 (25' 3")	8,120 (26' 8")	8,590 (28' 2")
B Max. digging depth	4,650 (15' 3")	4,850 (15' 11")	5,250 (17' 3")	5,750 (18' 10")
B' Max. digging depth (8' level)	4,390 (14' 5")	4,600 (15' 1")	5,040 (16' 6")	5,570 (18' 3")
C Max. vertical wall digging depth	4,350 (14' 3")	4,460 (14' 8")	5,030 (16' 6")	5,550 (18' 3")
D Max. digging height	8,400 (27' 7")	8,470 (27' 9")	8,790 (28' 10")	9,070 (29' 7")
E Max. dumping height	5,960 (19' 7")	6,040 (19' 10")	6,350 (20' 10")	6,620 (21' 9")
F Min. swing radius	2,620 (8' 7")	2,670 (8' 10")	2,650 (8' 8")	2,670 (8' 9")

# Dimensions & Working Range

## R140W-9A ADJUSTABLE BOOM

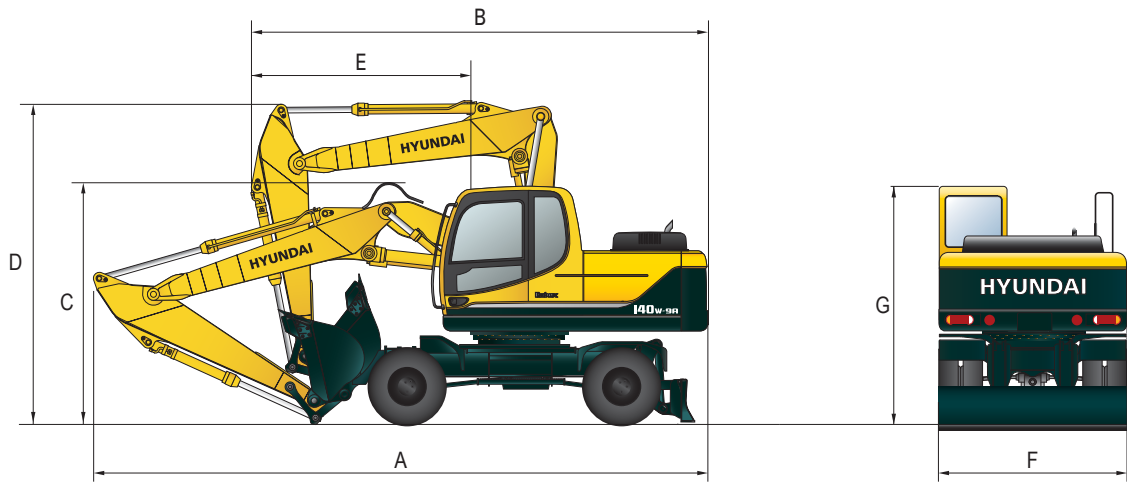

Unit : mm (ft · in)

Hydraulic adjustable Boom	4900(16' 1")		
Arm	1,900 (6' 3")	2,100 (6' 11")	2,500 (8' 2")
A Overall length of shipping position	8,140 (26' 8")	8,170 (26' 10")	8,150 (26' 9")
B Overall length of traveling position	6,090 (19' 12")	6,110 (20' 1")	6,130 (20' 1")
C Height of attachment(shipping position)	2,960 (9' 9")	3,060 (10' 0")	3,070 (10' 1")
D Height of attachment(traveling position)	3,980 (13' 1")	3,980 (13' 1")	3,980 (13' 1")
E End of attachment to steering wheel	2,950 (9' 8")	2,970 (9' 9")	2,990 (9' 10")
F Overall width	2,500 (8' 2")	2,500 (8' 2")	2,500 (8' 2")
G Height of cabin	3,140 (10' 4")	3,140 (10' 4")	3,140 (10' 4")

## R140W-9A ADJUSTABLE BOOM WORKING RANGE

Unit : mm (ft · in)

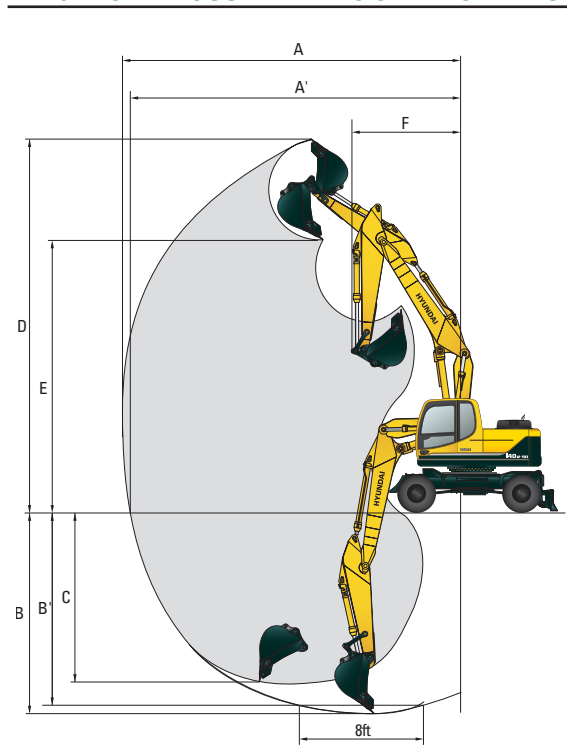

Boom length	4,900 (16' 1")		
Arm length	1,900 (6' 3")	2,100 (6' 11")	2,500 (8' 2")
A Max. digging reach	8,140 (26' 8")	8,310 (27' 3")	8,720 (28' 7")
A' Max. digging reach on ground	7,930 (26' 0")	8,110 (26' 7")	8,530 (28' 0")
B Max. digging depth	4,810 (15' 9")	5,010 (16' 5")	5,410 (17' 9")
B' Max. digging depth (8' level)	4,700 (15' 5")	4,890 (16' 1")	5,310 (17' 5")
C Max. vertical wall digging depth	4,190 (13' 9")	4,360 (14' 4")	4,820 (15' 10")
D Max. digging height	9,100 (29' 10")	9,180 (30' 1")	9,560 (31' 4")
E Max. dumping height	6,620 (21' 9")	6,700 (22' 0")	7,070 (23' 2")
F Min. swing radius	2,660 (8' 9")	2,820 (9' 3")	2,690 (8' 10")

# Undercarriage

R140W-9A WITH REAR DOZER

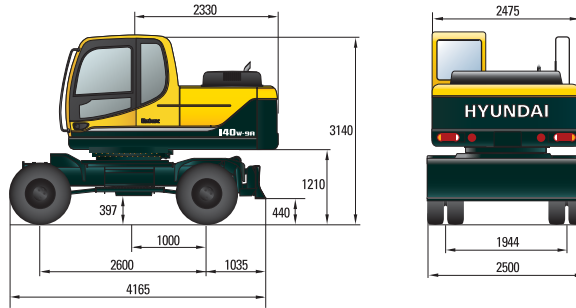

R140W-9A WITH REAR OUTRIGGER

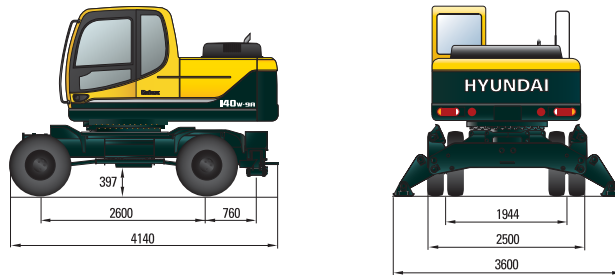

R140W-9A WITH REAR DOZER AND FRONT OUTRIGGER

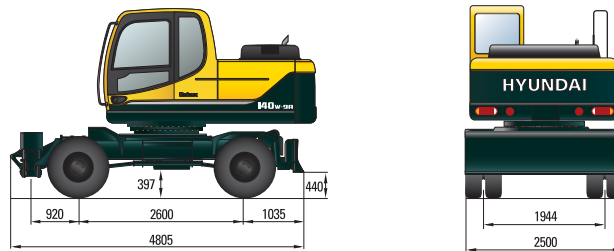

R140W-9A WITH REAR AND FRONT OUTRIGGER

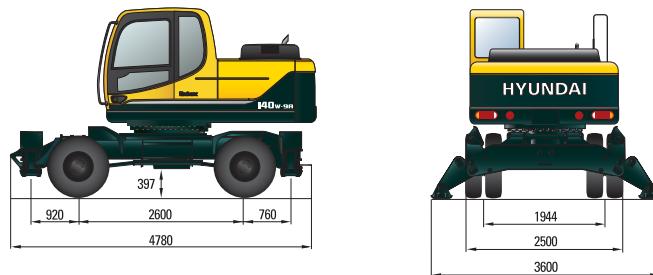

R140W-9A WITH REAR OUTRIGGER AND FRONT DOZER

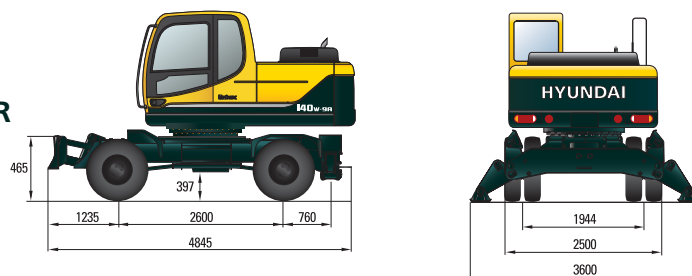













# Lifting Capacity











## R140W-9A MONO BOOM

 Rating over-front  Rating over-side or 360 degree











Boom : 4.6 m (15' 1") / Arm : 1.9 m (6' 3") / Bucket : 0.58 m<sup>3</sup> (0.76 yd<sup>3</sup>) SAE heaped / With rear dozer blade down

Load point height m (ft)	Load radius								At max. reach		Reach m (ft)	
	1.5 m (5.0 ft)		3.0 m (10.0 ft)		4.5 m (15.0 ft)		6.0 m (20.0 ft)		Capacity			
												
6.0 m (20.0 ft)	kg					*3350	*3350			*3200	2080	6.22
	lb					*7390	*7390			*7050	4590	(20.4)
4.5 m (15.0 ft)	kg					*3740	3550	*2860	2120	*3310	1610	7.05
	lb					*8250	7830	*6310	4670	*7300	3550	(23.1)
3.0 m (10.0 ft)	kg			*7070	6400	*4710	3330	*3900	2050	3370	1420	7.42
	lb			*15590	14110	*10380	7340	*8600	4520	7430	3130	(24.3)
1.5 m (5.0 ft)	kg			*7620	5740	*5750	3090	*4340	1960	3320	1380	7.42
	lb			*16800	12650	*12680	6810	*9570	4320	7320	3040	(24.3)
Ground	kg			*8960	5590	*6340	2940	*4600	1890	3590	1480	7.06
Line	lb			*19750	12320	*13980	6480	*10140	4170	7910	3260	(23.2)
-1.5 m (-5.0 ft)	kg	*7690	*7690	*9450	5620	*6250	2920			*3860	1830	6.24
	lb	*16950	*16950	*20830	12390	*13780	6440			*8510	4030	(20.5)
-3.0 m (-10.0 ft)	kg			*7750	5800	*5020	3030					
	lb			*17090	12790	*11070	6680					

Boom : 4.6 m (15' 1") / Arm : 2.1 m (6' 11") / Bucket : 0.58 m<sup>3</sup> (0.76 yd<sup>3</sup>) SAE heaped / With rear dozer blade down

Load point height m (ft)	Load radius								At max. reach		Reach m (ft)	
	1.5 m (5.0 ft)		3.0 m (10.0 ft)		4.5 m (15.0 ft)		6.0 m (20.0 ft)		Capacity			
												
6.0 m (20.0 ft)	kg					*3130	*3130			*3050	1950	6.43
	lb					*6900	*6900			*6720	4300	(21.1)
4.5 m (15.0 ft)	kg					*3540	*3540	*3210	2120	*3160	1520	7.23
	lb					*7800	*7800	*7080	4670	*6970	3350	(23.7)
3.0 m (10.0 ft)	kg			*6620	6450	*4510	3310	*3770	2040	3230	1340	7.59
	lb			*14590	14220	*9940	7300	*8310	4500	7120	2950	(24.9)
1.5 m (5.0 ft)	kg			*8650	5730	*5580	3060	*4230	1930	3180	1300	7.59
	lb			*19070	12630	*12300	6750	*9330	4250	7010	2870	(24.9)
Ground	kg			*9090	5510	*6240	2900	*4540	1860	3420	1390	7.24
Line	lb			*20040	12150	*13760	6390	*10010	4100	7540	3060	(23.8)
-1.5 m (-5.0 ft)	kg	*7380	*7380	*9530	5530	*6240	2860			*3760	1700	6.45
	lb	*16270	*16270	*21010	12190	*13760	6310			*8290	3750	(21.2)
-3.0 m (-10.0 ft)	kg	*11710	*11710	*7990	5690	*5240	2950					
	lb	*25820	*25820	*17610	12540	*11550	6500					

Boom : 4.6 m (15' 1") / Arm : 2.5 m (8' 2") / Bucket : 0.58 m<sup>3</sup> (0.76 yd<sup>3</sup>) SAE heaped / With rear dozer blade down

Load point height m (ft)	Load radius								At max. reach		Reach m (ft)	
	1.5 m (5.0 ft)		3.0 m (10.0 ft)		4.5 m (15.0 ft)		6.0 m (20.0 ft)		Capacity			
												
6.0 m (20.0 ft)	kg									*2820	1700	6.92
	lb									*6220	3750	(22.7)
4.5 m (15.0 ft)	kg					*3110	*3110	*2980	2150	*2880	1360	7.66
	lb					*6860	*6860	*6570	4740	*6350	3000	(25.1)
3.0 m (10.0 ft)	kg			*5700	*5700	*4110	3360	*3500	2050	*2930	1200	8.00
	lb			*12570	*12570	*9060	7410	*7720	4520	*6460	2650	(26.2)
1.5 m (5.0 ft)	kg			*8610	5850	*5270	3080	*4030	1930	2900	1160	8.00
	lb			*18980	12900	*11620	6790	*8880	4250	6390	2560	(26.2)
Ground	kg	*3820	*3820	*9000	5500	*6070	2890	*4430	1830	3090	1240	7.67
Line	lb	*8420	*8420	*19840	12130	*13380	6370	*9770	4030	6810	2730	(25.2)
-1.5 m (-5.0 ft)	kg	*6470	*6470	*9740	5460	*6260	2820	*4470	1800	*3510	1480	6.94
	lb	*14260	*14260	*21470	12040	*13800	6220	*9850	3970	*7740	3260	(22.8)
-3.0 m (-10.0 ft)	kg	*9750	*9750	*8560	5580	*5620	2870			*3480	2150	5.64
	lb	*21500	*21500	*18870	12300	*12390	6330			*7670	4740	(18.5)













- Lifting capacity is based on SAE J1097, ISO 10567.
- Lifting capacity of the Robex Series does not exceed 75% of the tipping load with the machine on firm, level ground or 87% of full hydraulic capacity.
- The load point is a hook located on the back of the bucket.
- (\*) indicates the load limited by hydraulic capacity.

# Lifting Capacity

## R140W-9A MONO BOOM

 Rating over-front  Rating over-side or 360 degree









Boom : 4.6 m (15' 1") / Arm : 3.0 m (9' 10") / Bucket : 0.58 m<sup>3</sup> (0.76 yd<sup>3</sup>) SAE heaped / With rear dozer blade down

Load point height m (ft)		Load radius										At max. reach		
		1.5 m (5.0 ft)		3.0 m (10.0 ft)		4.5 m (15.0 ft)		6.0 m (20.0 ft)		7.5 m (25.0 ft)		Capacity		Reach
														m (ft)
6.0 m	kg							*2100	*2100			*2570	1480	7.46
(20.0 ft)	lb							*4630	*4630			*5670	3260	(24.5)
4.5 m	kg							*2710	2200			*2590	1210	8.14
(15.0 ft)	lb							*5970	4850			*5710	2670	(26.7)
3.0 m	kg					*3580	3450	*3170	2090	*1780	1350	*2640	1080	8.46
(10.0 ft)	lb					*7890	7610	*6990	4610	*3920	2980	*5820	2380	(27.8)
1.5 m	kg			*7700	6080	*4840	3150	*3770	1960	*2190	1290	2640	1040	8.46
(5.0 ft)	lb			*16980	13400	*10670	6940	*8310	4320	*4830	2840	5820	2290	(27.8)
Ground	kg	*3780	*3780	*9530	5580	*5830	2920	*4280	1840	*1820	1250	2780	1100	8.15
Line	lb	*8330	*8330	*21010	12300	*12850	6440	*9440	4060	*4010	2760	6130	2430	(26.7)
-1.5 m	kg	*5830	*5830	*9890	5450	*6250	2810	*4490	1780			3210	1280	7.48
(-5.0 ft)	lb	*12850	*12850	*21800	12020	*13780	6190	*9900	3920			7080	2820	(24.5)
-3.0 m	kg	*8470	*8470	*9150	5500	*5950	2820	*3320	1810			*3390	1750	6.31
(-10.0 ft)	lb	*18670	*18670	*20170	12130	*13120	6220	*7320	3990			*7470	3860	(20.7)
-4.5 m	kg			*6890	5740									
(-15.0 ft)	lb			*15190	12650									









## R140W-9A ADJUSTABLE BOOM

 Rating over-front  Rating over-side or 360 degree

Boom : 4.9 m (16' 9") / Arm : 1.9 m (6' 3") / Bucket : 0.58 m<sup>3</sup> (0.76 yd<sup>3</sup>) SAE heaped / With rear dozer blade down

Load point height m (ft)		Load radius						At max. reach		
		3.0 m (10.0 ft)		4.5 m (15.0 ft)		6.0 m (20.0 ft)		Capacity		Reach
										
6.0 m	kg			*2960	*2960			*2910	1790	6.70
(20.0 ft)	lb			*6530	*6530			*6420	3950	(22.0)
4.5 m	kg	*4240	*4240	*3500	*3500	*3230	2110	*3010	1410	7.46
(15.0 ft)	lb	*9350	*9350	*7720	*7720	*7120	4650	*6640	3110	(24.5)
3.0 m	kg			*4520	3250	*3630	2020	3080	1250	7.81
(10.0 ft)	lb			*9960	7170	*8000	4450	6790	2760	(25.6)
1.5 m	kg			*5550	2980	*4110	1900	3040	1220	7.81
(5.0 ft)	lb			*12240	6570	*9060	4190	6700	2690	(25.6)
Ground	kg	*6150	5410	*6150	2840	*4450	1830	3260	1310	7.47
Line	lb	*13560	11930	*13560	6260	*9810	4030	7190	2890	(24.5)
-1.5 m	kg	*9320	5480	*6170	2820	*4410	1820	*3580	1590	6.72
(-5.0 ft)	lb	*20550	12080	*13600	6220	*9720	4010	*7890	3510	(22.0)
-3.0 m	kg			*5400	2920					
(-10.0 ft)	lb			*11900	6440					

Boom : 4.9 m (16' 9") / Arm : 2.1 m (6' 11") / Bucket : 0.58 m<sup>3</sup> (0.76 yd<sup>3</sup>) SAE heaped / With rear dozer blade down

Load point height m (ft)		Load radius						At max. reach		
		3.0 m (10.0 ft)		4.5 m (15.0 ft)		6.0 m (20.0 ft)		Capacity		Reach
										
6.0 m	kg			*2770	*2770			*2780	1680	6.91
(20.0 ft)	lb			*6110	*6110			*6130	3700	(22.7)
4.5 m	kg			*3300	*3300	*3090	2110	*2880	1330	7.65
(15.0 ft)	lb			*7280	*7280	*6810	4650	*6350	2930	(25.1)
3.0 m	kg			*4320	3240	*3500	2000	2950	1180	7.99
(10.0 ft)	lb			*9520	7140	*7720	4410	6500	2600	(26.2)
1.5 m	kg			*5380	2950	*4000	1870	2910	1140	7.99
(5.0 ft)	lb			*11860	6500	*8820	4120	6420	2510	(26.2)
Ground	kg	*6320	5320	*6040	2790	*4370	1790	3110	1220	7.66
Line	lb	*13930	11730	*13320	6150	*9630	3950	6860	2690	(25.1)
-1.5 m	kg	*9370	5370	*6140	2760	*4400	1770	*3480	1470	6.93
(-5.0 ft)	lb	*20660	11840	*13540	6080	*9700	3900	*7670	3240	(22.7)
-3.0 m	kg			*5500	2840					
(-10.0 ft)	lb			*12130	6260					

1. Lifting capacity is based on SAE J1097, ISO 10567.

2. Lifting capacity of the Robex Series does not exceed 75% of the tipping load with the machine on firm, level ground or 87% of full hydraulic capacity.

3. The load point is a hook located on the back of the bucket.











4. (\*) indicates the load limited by hydraulic capacity.

# Lifting Capacity

## R140W-9A ADJUSTABLE BOOM

 Rating over-front  Rating over-side or 360 degree

Boom : 4.9 m (16' 9") / Arm : 2.5 m (8' 2") / Bucket : 0.58 m<sup>3</sup> (0.76 yd<sup>3</sup>) SAE heaped / With rear dozer blade down

Load point height m (ft)		Load radius								At max. reach		Reach m (ft)
		3.0 m (10.0 ft)		4.5 m (15.0 ft)		6.0 m (20.0 ft)		7.5 m (25.0 ft)		Capacity		
												
6.0 m	kg					*2560	2180			*2580	1470	7.39
(20.0 ft)	lb					*5640	4810			*5690	3240	(24.2)
4.5 m	kg			*2900	*2900	*2800	2140			*2680	1180	8.08
(15.0 ft)	lb			*6390	*6390	*6170	4720			*5910	2600	(26.5)
3.0 m	kg	*5850	*5850	*3940	3290	*3250	2010	*2020	1300	2700	1050	8.40
(10.0 ft)	lb	*12900	*12900	*8690	7250	*7170	4430	*4450	2870	5950	2310	(27.6)
1.5 m	kg	*6100	5580	*5080	2980	*3800	1870	*2540	1250	2660	1020	8.40
(5.0 ft)	lb	*13450	12300	*11200	6570	*8380	4120	*5600	2760	5860	2250	(27.6)
Ground	kg	*6370	5300	*5870	2780	*4240	1770			2820	1080	8.09
Line	lb	*14040	11680	*12940	6130	*9350	3900			6220	2380	(26.5)
-1.5 m	kg	*9040	5290	*6120	2720	*4400	1730			*3240	1280	7.41
(-5.0 ft)	lb	*19930	11660	*13490	6000	*9700	3810			*7140	2820	(24.3)
-3.0 m	kg	*8660	5430	*5730	2770							
(-10.0 ft)	lb	*19090	11970	*12630	6110							

1. Lifting capacity is based on SAE J1097, ISO 10567.
2. Lifting capacity of the Robex Series does not exceed 75% of the tipping load with the machine on firm, level ground or 87% of full hydraulic capacity.
3. The load point is a hook located on the back of the bucket.
4. (\*) indicates the load limited by hydraulic capacity.

## STANDARD EQUIPMENT

### ISO Standard cabin

All-weather steel cab with 360° visibility  
Safety glass windows  
Rise-up type windshield wiper  
Sliding fold-in front window  
Sliding side window(LH)  
Lockable door  
Hot & cool box  
Storage compartment & Ashtray  
Transparent cabin roof-cover  
Radio & USB Player  
Handsfree mobile phone system with USB, Bluetooth, Radio cable-Handsfree  
Sun visor

### Computer aided power optimization (New CAPO) system

3-power mode, 3-work mode, user mode  
Auto deceleration & one-touch deceleration system  
Auto warm-up system  
Auto overheat prevention system

### Automatic climate control

Air conditioner & heater  
Defroster

### Self-diagnostics system

### Starting Aid (air grid heater) for cold weather

### Centralized monitoring

LCD display  
Engine speed or Trip meter/Accel.  
Clock  
Gauges  
Fuel level gauge  
Engine coolant temperature gauge  
Hyd. oil temperature gauge  
Warnings  
Check Engine  
Overload  
Communication error  
Low battery  
Air cleaner clogging  
Indicators  
Max power  
Low speed/High speed  
Fuel warmer  
Auto idle

### Door and cab locks, one key

### Two outside rearview mirrors

### Fully adjustable suspension seat with seat belt

### Adjustable air suspension seat with heater

### Pilot-operated slidable joystick

### Console box height adjust system

### Two front working lights

### Electric horn

### Batteries (2 x 12V x 100 AH)

### Battery master switch

### Removable clean-out screen for cooler

### Automatic swing brake

### Removable reservoir tank

### Fuel pre-filter with fuel warmer

### Boom holding system

### Arm holding system

### Accumulator for lowering work equipment

### Electric Transducers

### Lower frame under cover (Normal)

### Viscous fan clutch

### Rear-blade (550mm X 2,500mm)

### Tires-dual (9.00-20-14PR)

### Travel alarm

## OPTIONAL EQUIPMENT

### Fuel filler pump (35 L/min)

### Beacon lamp

### Safety lock valve for boom cylinder with overload warning device

### Safety lock valve for arm cylinder

### Single-acting piping kit (breaker, etc.)

### Double-acting piping kit (clamshell, etc.)

### Quick coupler

### 12 volt power outlet (24V DC to 12V DC converter)

### Booms

4.6m, 15' 1"

4.9m, 16' 1" Hyd. adjustable boom

### Arms

1.9m, 6' 3"

2.1m, 6' 11"

2.5m, 8' 2"

3.0m, 9' 10"

### Cabin FOPS/FOG (ISO/DIS 10262 Level II)

FOPS (Falling Object Protective Structure)

FOG (Falling Object Guard)

### Cabin ROPS (ISO 12117-2)

### Cabin roof-steel cover

### Cabin front guard-wire net

### Cabin lights

### Cabin front window rain guard

### Undercarriage

Rear outrigger

Rear dozer and front outrigger

Rear and front outrigger

Rear outrigger and front dozer

### Lower frame under cover (Additional)

### Tool kit

### Rearview camera

### Seat

Adjustable air suspension seat

Mechanical suspension seat with heater

Mechanical suspension seat

### Tires - dual (9.00 - 20 solid), dual (10.00 - 20 - 14PR lube type)

### Pattern change valve (2 patterns)

### Hi-mate (Remote Management System)

### Smart key

\* Standard and optional equipment may vary. Contact your Hyundai dealer for more information. The machine may vary according to International standards.

\* The photos may include attachments and optional equipment that are not available in your area.

\* Materials and specifications are subject to change without advance notice.

\* All imperial measurements rounded off to the nearest pound or inch.

PLEASE CONTACT



6100 Atlantic Blvd, Norcross, GA 30071

TEL (678) 823-7777 FAX (678) 823-7778