

Snowblowers | Triplex Finishing Mower | Stump Grinder | Brush Grapple | Rotary Sweep
Snow Blade | Rear Blade | Quick Hitch | Loader Attachment



Allied by Farm King Commercial Equipment:
snowblowers, mowers, attachments



FARM KING PRODUCT LINE-UP

FARM KING PRODUCT CATEGORIES

Grain Handling

Tillage

Application Equipment

Hay Tools

Landscaping Equipment

Allied by Farm King - Commercial
Products

WWW.FARM-KING.COM

ALLIED HAS A LONG HISTORY OF QUALITY- BUILT AGRICULTURAL AND COMMERCIAL GRADE ATTACHMENTS.

A wide variety of equipment has been developed to meet the tough demands of farmers, contractors and landscapers. The products that carry the Allied by Farm King brand uphold the tradition of durable equipment that is adaptable to any environment.

TABLE OF CONTENTS

Quick Hitch.....4

Binary Snowblower5

Snowblower 6-7

Hydraulic Snowblower.. 8-9

Triplex Finishing Mower10-11

Stump Grinder12

Brush Grapple.....13

Rotary Sweep.....14

Snow Blade15

Rear Blade16-18

Loader Attachments..... 19





QUICK HITCH

Category I, II, III, II/III

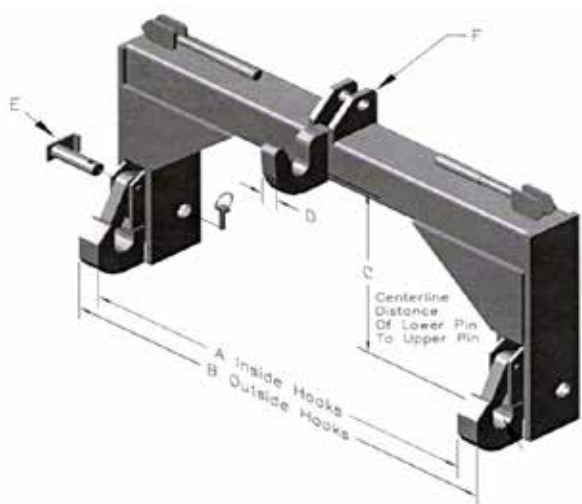

THE BEST PART ABOUT OWNING A TRACTOR IS PUTTING IT TO GOOD USE.

Regardless of the size of your tractor, a number of implements are available to maximize the usefulness of your machine. Whether you have a compact utility tractor or a large four-wheel-drive, the quick hitch can be matched to various types of mowers, tillers, rear blades, box scrapers, cultivators and rakes to turn any tractor into a multi-purpose farming tool.

SPECIFICATIONS

MODEL >>	C3101	C3201	C3301	C3231
Category	I	II	III	II / III
A	27-1/4	32-3/4	38-1/4	38-1/4
B	29-1/2	36-1/4	42-3/4	42-3/4
C	14-1/2 to 17-1/4	14-7/8	18-7/8	19
D	1-1/4	1-1/4	1-1/4	1-1/4
E	7/8	1-1/8	1-7/16	1-1/8
F	3/4	1	1-1/4	1-1/4
Weight	76 lb	134 lb	182 lb	185 lb

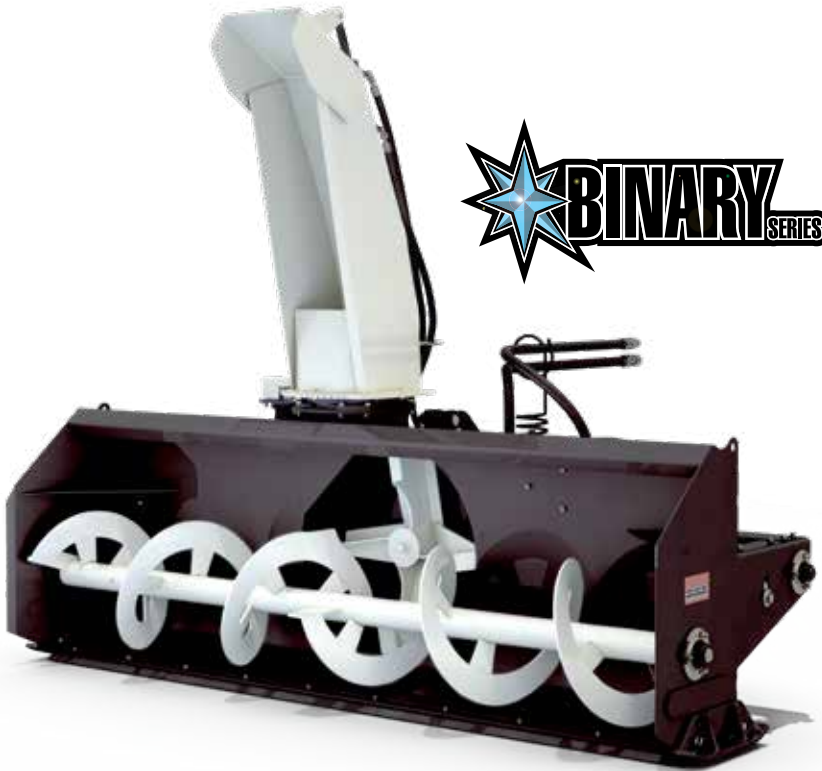

THE ALLIED BY FARM KING BINARY SNOWBLOWER OFFERS TWO IMPLEMENTS IN ONE MACHINE.

Allied by Farm King has been building reliable agricultural and commercial snowblowers for more than four decades.

Farmers are making the most of their equipment assets and the Allied by Farm King Binary Snowblower offers the flexibility to be used on a skid steer or a tractor with a PTO and 3-point hitch.

SPECIFICATIONS											
MODEL	H500		H600		H660		H740		H840		
Hydraulic flow	Standard	High	Standard	High	Standard	High	Standard	High	Standard	High	
Cutting width	50"		60"		66"		74"		84"		
Cutting height	24"		24"		24"		25"		25"		
Cutting edge	Replaceable opt.		Replaceable opt.		Replaceable opt.		Replaceable opt.		Replaceable opt.		
Mount plate	Universal		Universal		Universal		Universal		Universal		
Hydraulic requirements	17-23 gpm	23-26 gpm	17-23 gpm	23-26 gpm	17-23 gpm	23-26 gpm	17-23 gpm	23-26 gpm	17-23 gpm	23-26 gpm	
Hydraulic horsepower, max	44 hp @ 3300 PSI	69 hp @ 3300 PSI	44 hp @ 3300 PSI	69 hp @ 3300 PSI	44 hp @ 3300 PSI	69 hp @ 3300 PSI	44 hp @ 3300 PSI	69 hp @ 3300 PSI	44 hp @ 3300 PSI	69 hp @ 3300 PSI	
Fan speed, max	664 RPM	699 RPM	664 RPM	699 RPM	664 RPM	699 RPM	664 RPM	699 RPM	664 RPM	699 RPM	
Fan torque, max	3350 ft-lb	521 ft-lb	3350 ft-lb	521 ft-lb	3350 ft-lb	521 ft-lb	3350 ft-lb	521 ft-lb	3350 ft-lb	521 ft-lb	
Fan	4 blade		4 blade		4 blade		4 blade		4 blade		
Fan diameter	22"		22"		22"		23"		23"		
Fan drive motor	8.0 cuin	11.9 cuin	8.0 cuin	11.9 cuin	8.0 cuin	11.9 cuin	8.0 cuin	11.9 cuin	8.0 cuin	11.9 cuin	
Fan drive	#80 Chain	#80HS	#80 Chain	#80HS	#80 Chain	#80HS	#80 Chain	#80HS	#80 Chain	#80HS	
Auger diameter	15"		15"		15"		15"		15"		
Auger drive	#50 Chain		#50 Chain		#50 Chain		#50 Chain		#50 Chain		
Chute rotation	Hydraulic 270°		Hydraulic 270°		Hydraulic 270°		Hydraulic 270°		Hydraulic 270°		
Chute deflector	Hydraulic		Hydraulic		Hydraulic		Hydraulic		Hydraulic		
Skid shoes	Adjustable and replaceable		Adjustable and replaceable		Adjustable and replaceable		Adjustable and replaceable		Adjustable and replaceable		
Weight	480 lb		528 lb		573 lb		814 lb		906 lb		

6 • STANDARD SNOWBLOWER

SNOWBLOWER

PRODUCT OVERVIEW

Rear attach for use on acreages, farms and municipalities

Category I, II & III

15 - 225 hp required

FEATURES

Spout rotator and deflector available as manual or hydraulic

Standard shear bolts on all PTOs

OPTIONS

Commercial and truck loader chute, model 1080 and 1200



SNOWBLOWER

5010, 6010, 6610, 7420, 8420, 9620, 1080, 1200



SPOUT DEFLECTOR

The spout deflector can be equipped with a hydraulic cylinder kit or a 6-position manual adjustment.

HITCH

Most models feature an adjustable hitch that is designed to adapt to 3-point hitches of varying lengths and heights, which reduces stress on the PTO shaft.

GEARBOX

The oil bath gearbox, available on 84", 96", 108" and 1200 models, adds longevity.

FAN

A 4-blade fan is standard on all models. Dual augers are standard on model widths 96" to 120".

SPOUT ROTATOR

The spout rotator is available with manual or hydraulic positioning.

SKID SHOES

Adjustable/replaceable skid shoes are standard on all models.



ALLIED HAS BEEN BUILDING RELIABLE SNOWBLOWERS FOR MORE THAN THREE DECADES.

Through the years the design has been refined to create an excellent snowblower that is easy to use and maintain. PTO-driven Allied snowblowers attach to 3-point hitch and are available in widths ranging from 50" to 120".

[1] #50, #60 or #80 sized chain dependant on model **[2]** Dual augers **[3]** 7 foot commercial and 10 foot truck loading chutes are optional on the 1080 and 1200 models. **[4]** Binary models available in widths of 50-84"; Propeller models available in all models.



SPECIFICATIONS

MODEL >>	5010	6010	6610	7420	8420	8420G	9620	1080	1200
Cutting width / height	50" / 25"	60" / 25"	66" / 24"	74" / 25"	84" / 25"	84" / 25"	96" / 36"	108" / 41"	120" / 41"
Replaceable cutting edge	N/A	N/A	N/A	N/A	N/A	N/A	Optional	Yes	Yes
Fan type / diameter	4-blade / 22"	4-blade / 22"	4-blade / 22"	4-blade / 23"	4-blade / 23"	4-blade / 23"	4-blade / 32"	4-blade / 36"	4-blade / 36"
Replaceable fan housing	N/A	N/A	N/A	N/A	N/A	N/A	N/A	7 gauge	7 gauge
Drive fan	540 rpm open gear					540 rpm oil bath gearbox		1000 rpm oil bath gearbox	
Auger diameter	15"	15"	15"	15"	15"	15"	15" (dual)	15" (dual)	15" (dual)
Auger drive	#50 chain	#50 chain	#50 chain	#50 chain	#50 chain	#50 chain	#60 chain	#80 chain	#80 chain
Spout rotator - manual (hand crank) - hydraulic	Standard Optional	Standard Optional	Standard Optional	Optional Standard	Optional Standard	Optional Standard	Optional Standard	N/A Standard	N/A Standard
Spout deflector - manual (6 position) - hydraulic	Standard Optional	Standard Optional	Standard Optional	Standard Optional	Standard Optional	Standard Optional	Standard Optional	N/A Standard	N/A Standard
Skid shoes	Adjustable and replaceable								
Hitch category	Cat. I standard	Cat. I standard	Cat. I standard	Cat. I standard Cat. II bushings Cat. I & II heavy frame optional	Cat. II std Cat. II Q.H. std Cat. III Q.H. narrow	Cat. II std Cat. II Q.H. std Cat. III Q.H. narrow	Cat. I & II std Cat. II Q.H. std Cat. III Q.H. narrow	Cat. II std Cat. III Q.H. std Cat. III Q.H. narrow	Cat. II std Cat. III Q.H. std Cat. III Q.H. narrow
Hitch adjustment	4 position	4 position	4 position	2 position	2 position	2 position	Fixed	2 position	2 position
HP requirement	15 - 30 hp	20 - 40 hp	22 - 40 hp	40 - 70 hp	60 - 90 hp	60 - 90 hp	90 - 125 hp	120 - 180 hp	180 - 225 hp
Weight	422 lb	470 lb	515 lb	756 lb	848 lb	878 lb	1243 lb	2398 lb	2600 lb

8 • HD HYDRAULIC SNOWBLOWER

HD HYDRAULIC SNOWBLOWER

PRODUCT OVERVIEW

Built for skid steer attachment

Widths range from 60" to 84"

17 to 40 GPM

FEATURES

All components are hydraulically driven

Replaceable cutting edge

Adjustable skid shoes are standard

Heavy-gauge steel

OPTIONS

6" width extenders



HD HYDRAULIC SNOWBLOWER

Models 6025, 7225, 7235, 8425, 8435



HYDRAULIC MOTOR CHAIN DRIVE ASSEMBLY

With a hood turning range of 270° Allied by Farm King HD Hydraulic Snowblowers give you superior control when moving snow.

WIRING HARNESS

The Allied by Farm King HD Hydraulic Snowblower series have a wiring harness to fit almost any brand on the market. Compatibility available with: Bobcat 14, pin ASV, Cat "B / C / D" series 8 pin, Case / New Holland 14 pin and

John Deere 14 pin. A magnetic cab mounted control box is available on all other models.

HYDRAULIC MOTORS

Allied by Farm King HD Hydraulic Snowblowers have hydraulic motors mounted directly on the fan and auger shaft eliminating couplers and chain drive assemblies for simplicity and ease of maintenance. A hydraulic relief replaces traditional shear pin technology for increased productivity and reduced downtime.



THE ALLIED BY FARM KING HD HYDRAULIC SNOWBLOWERS HAVE BEEN ENGINEERED TO MAXIMIZE YOUR SKID STEERS EFFICIENCY.

Available in high and standard flow configurations, Allied by Farm King blowers will connect with any modern skid steer. Designed to be durable and reliable, Allied by Farm King products are the best choice for industrial and commercial snow removal.



[1] Hydraulic motor chain drive. **[2]** Wiring harness fits most skid steer brands. **[3]** A hydraulic motor mounts directly on the fan and auger shaft eliminating couplers and chain drive assembly.

SPECIFICATIONS

MODEL	6025	7225	7235	8425	8435
Cutting width	60"	72"	72"	84"	84"
Cutting height	25"	25"	35"	25"	35"
Mount plate	Universal	Universal	Universal	Universal	Universal
Hydraulic requirements	17 - 23 GPM	17 - 23 GPM	32 - 40 GPM	17 - 23 GPM	32 - 40 GPM
Throwing distance	Up to 40'	Up to 40'	Up to 40'	Up to 40'	Up to 40'
Fan	4-blade	4-blade	4-blade	4-blade	4-blade
Fan diameter	20"	20"	24"	20"	24"
Auger diameter	14"	14"	18"	14"	18"
Drive auger	Hydraulic motor	Hydraulic motor	Hydraulic motor	Hydraulic motor	Hydraulic motor
Chute rotation	270°	270°	270°	270°	270°
Chute deflector	Hydraulic	Hydraulic	Hydraulic	Hydraulic	Hydraulic
Cutting edge	½" x 4" bolt-on	½" x 4" bolt-on	½" x 4" bolt-on	½" x 4" bolt-on	½" x 4" bolt-on
Skid shoes	Adjustable and replaceable	Adjustable and replaceable	Adjustable and replaceable	Adjustable and replaceable	Adjustable and replaceable
Weight	828 lb	923 lb	1084 lb	951 lb	1108 lb

TRIPLEX FINISHING MOWER

PRODUCT OVERVIEW

One of the highest measured tip speeds in the industry creates powerful suction for a clean cut

45 to 80 hp required

FEATURES

Slide adjustment on the gearbox for easy belt tensioning

Blade overlap of 1-5/8" to 2-5/8" minimizes stripping

Hard surface cutting edges are standard on all models

OPTIONS

2-5/16" ball hitch



TRIPLEX FINISHING MOWER

Models 450, 550, 650 and 750

TRANSPORT

The Triplex Finishing Mower is designed to be transported with ease. A cast clevis hitch is standard and a 2-5/16" ball hitch is optional for road transport. The 5-position hitch adjustment makes it easy to move, regardless of the hitch height of the tow vehicle. The decks are lifted into position by hydraulic cylinders and are automatically locked in place for transport. The decks are unlocked right from the tractor seat using a cable, or can be released using the optional hydraulic system.

ROLLER BEARINGS

Tapered roller bearings in the wheel hubs ensure long-term reliability without needing frequent lubrication. The standard front UHMW roller prevents scalping on uneven turf.

BLADE OVERLAP

There is a 1-5/8" blade overlap on the 450, while all the other models have a 2-5/8" blade overlap. This overlap helps to prevent stripping, especially when turning.

YOKE DESIGN

A forgiving yoke design creates the ability to follow the terrain, yet maintain a seamless finish, available on models 550 and 650.

WHEELS

The model 750 has four wheels on each of the three decks. Models 650 and 550 have four wheels on the wing decks and two on the center deck. The 450 has three wheels on the wing decks and two on the center deck.



ALLIED BY FARM KING HAS BEEN MAKING FINISHING MOWERS FOR MORE THAN 15 YEARS.

Three of these finishing mowers together create one magnificent volume grass trimmer: the Triplex Finishing Mower. Nine blades generate a powerful vacuum for a crisp, clean cut. Each deck floats independently over rolling terrain for a uniform, manicured trim.

[1] Heavy-duty deck and structural supports have solid reinforcing rods around the edges. **[2]** Adjustable poly roller to prevent scalping. **[3]** Each wheel assembly includes a cutting height adjustment on the 1-1/4 inch wheel yoke shaft. **[4]** Transport position.



SPECIFICATIONS

MODEL	450	550	650	750
Cutting width	11' (3.35 m)	13.6' (4.15 m)	16' (4.88 m)	19.9' (6.07 m)
Transportation width bottom / top, approx.	67" / 67"	86" / 100"	67" / 67"	79" / 102"
Transportation height / length, approx.	92" / 15' 9"	84-1/2" / 15' 9"	92" / 15' 9"	121-1/2" / 16' 9"
Recommended horsepower	45 hp	55 hp	65 hp	80 hp
Wing frame	2" x 3" x 1/4" wall tube	2" x 3" x 1/4" wall tube	2" x 3" x 1/4" wall tube	2" x 3" x 1/4" wall tube
Wing flex*	30° up 17° down	35° up 16° down	30° up 11° down	30° up 11° down
Deck overlap	5"	8.5"	8"	8"
Gear box rating at 540 RPM	66 horsepower - divider box / 30 horsepower - wing boxes			
Hitch type	Cast clevis - standard, 2 5/16" ball hitch - optional			
Driveline main / wings	Series 4-80° CV / series 2	Series 6-80° CV / series 2	Series 6-80° CV / series 2	Series 6-80° CV / series 2
Deck width / thickness	4' / 10 Ga.	5' / 7 Ga.	6' / 7 Ga.	7' / 7 Ga.
Deck tires	8 (15" x 6" x 6")	10 (15" x 6" x 6")	10 (15" x 6" x 6")	12 (15" x 6" x 6")
Main frame tire	2 (27" x 10-1/2" x 15")	2 (27" x 10-1/2" x 15")	2 (27" x 10-1/2" x 15")	2 (27" x 10-1/2" x 15")
Blades per deck / overlap	3 blades / 1-5/8"	3 blades / 2-5/8"	3 blades / 2-5/8"	3 blades / 2-5/8"
Blade tip speed	15,485 ft/min	15,829 ft/min	18,737 ft/min	18,552 ft/min
Cutting height	1-1/2" to 4-1/2"	1-1/2" to 4-1/2"	1-1/2" to 4-1/2"	1-1/2" to 4-1/2"
Mower drive system	2 belt B groove	2 belt B groove	2 belt B groove	2 belt B groove
Front roller	4" x 7" UHMW Poly	4" x 7" UHMW Poly	4" x 7" UHMW Poly	4" x 7" UHMW Poly
Weight	2730 lb	3919 lb	3590 lb	4633 lb

* Not recommended for operation greater than 30°, actual measurement based on mower deck flex.



[1] Large 26 and 36 inch cutting wheel diameter.

[2] Manual tilt adjustment up to 15 degrees.



STUMP GRINDER

Skid Steer and 3-Point Mount

STUMP GRINDER

PRODUCT OVERVIEW

Constructed for fast and easy stump removal

Category I, II and Universal skid steer

15 - 45 hp required

FEATURES

Carbide-tipped cutting teeth

5 – 8 inches of cutting depth

Rubber chip deflector

3/4 inch cutting wheel thickness

Easily accessible grease fittings

THE ALLIED BY FARM KING STUMP GRINDER CAN CUT THROUGH EVEN THE HARDEST STUMPS.

The impressive 45 degree swing arc allows the stump grinder to cover greater surface areas of larger trees. The grinder is easily controlled using the tractor or skid steer hydraulic levers. Both 3-point hitch grinder models use a slip clutch with the skid steer unit using system pressure.

SPECIFICATIONS

MODEL	2628	3633	2628H
Hitch	Cat. I	Cat. I / II	Universal skid steer
Overall length	75"	80"	72"
Drive system protection	Slip clutch	Slip clutch	System pressure
Gearbox rating / ratio	60 hp / 1:1.5	100 hp / 1:1.46	60 hp / 1:1.5
Cutting wheel construction	Welded 2 piece laminated steel		
Cutting wheel thickness	3/4"	3/4"	3/4"
Cutting wheel diameter	26"	36"	26"
Cutting wheel speed @540 PTO RPM	810 RPM, 5,515 ft/min	788 RPM, 7,430 ft/min	810 RPM, 5,515 ft/min
Number of teeth	33	42	33
Cutting teeth construction	Carbide steel bolt in	Carbide steel bolt in	Carbide steel bolt in
Cut height above ground	18"	18"	18"
Cut depth below ground	10"	15"	10"
Max. cut depth per pass	5"	8"	5"
Max. horizontal cut	28"	33"	28"
Swing arc	45°	45°	45°
Min. power / flow required	22 PTO hp	45 PTO hp	15 GPM
Max. power / flow	50 PTO hp	100 PTO hp	25 GPM
Drive system	PTO / Series 5	PTO / Series 6	Hydraulic
PTO speed	540 RPM	540 RPM	540 RPM @ 19.4 GPM
Weight	660 lb	880 lb	757 lb



BRUSH GRAPPLE

Models 6254, 7764

STUMP GRINDER

PRODUCT OVERVIEW

Constructed for picking up brush and other debris

Available in widths of 62 and 77 inches

95 - 150 hp required

FEATURES

Reinforced tubes between lower tines

Serrated upper tines

Pivot Pin designed with tight tolerances

Hardened steel construction

OPTIONS

Available in skid steer or tractor mounting configurations

THE LARGE 50 INCH GRAPPLE OPENING ALLOWS THE OPERATOR TO PICK LARGE QUANTITIES OF BRANCHES AT ONE TIME.

Two 2500 psi cylinders squeeze any kind of brush quickly and easily. Simply mount the Allied brush grapple to the front of any loader for increased versatility.

[1] Tine points are designed to go under logs and brush, leaving nothing on the ground. **[2]** Replaceable weld-on tine points.

SPECIFICATIONS

MODEL	6254	7764
Overall width	62"	77"
Overall depth	25"	25"
Overall height closed	54"	54"
Grapple opening	50"	50"
Upper grapple widths	19.25"	19.25"
Tine Spacing	15"	15"
Number of tines / grapples (lower / upper)	5 / 4	5 / 4
Reinforcing tubes between lower tines	Standard	Standard
Number of hydraulic cylinders	2	2
Cylinder bore	2"	2"
Cylinder stroke	10"	10"
Cylinder rod diameter	1.125"	1.125"
Cylinder pressure rating	2500 psi	2500 psi
Horsepower rating, maximum	95 PTO HP	150 PTO HP
Weight	790 lb	970 lb

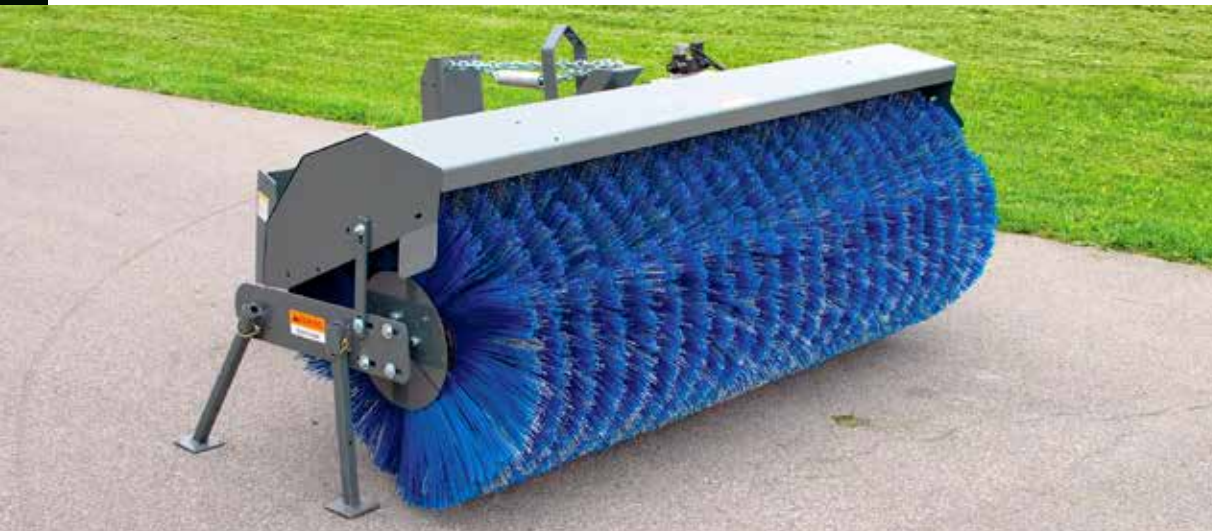

ROTARY SWEEP

3-Point and Skid Steer Mount

ROTARY SWEEP

PRODUCT OVERVIEW

For use in municipalities, farms, construction sites and airports; built to remove dirt, sand, gravel and trash

Category I and skid steer

Broom angles up to 30° right or left

FEATURES

Large brush diameter of 32 inches

Double gearbox drive

OPTIONS

Sprinkler system for dust control / Dirt deflector

THE ALLIED BY FARM KING ROTARY SWEEP CUTS CLEANING JOBS IN HALF WITH A RUGGED AND DURABLE DESIGN.

The rotary sweep is available in 5 to 7 foot sweeping widths, making sure no surface goes untouched. Rear mounted for tractors and front mounted for skid steers allows the Allied rotary sweep to easily be maneuvered around obstacles.

[1] Poly or a combination of poly and wire brushes is available. **[2]** Quick attach skid steer mounts for easy hook up.

SPECIFICATIONS - 3-POINT MOUNT

MODEL >>	6032P	6032W	7232P	7232W	8432P	8432W
Overall width	69"	69"	81"	81"	93"	93"
Brush diameter	32"	32"	32"	32"	32"	32"
Sweeping width	60"	60"	72"	72"	84"	84"
Width at 30° angle	53"	53"	64"	64"	76"	76"
Mounting system	Cat. I	Cat. I	Cat. I	Cat. I	Cat. I	Cat. I
Brush material	Poly	Poly / Wire	Poly	Poly / Wire	Poly	Poly / Wire
PTO RPM range	540	540	540	540	540	540
Sprinkler system	Opt.	Opt.	Opt.	Opt.	Opt.	Opt.
Dirt deflector	Opt.	Opt.	Opt.	Opt.	Opt.	Opt.
Weight	640 lb	640 lb	740 lb	840 lb	740 lb	840 lb

SPECIFICATION - SKID STEER MOUNT

MODEL >>	6032PS	6032WS	7232PS	7232WS	8432PS	8432WS
Overall width	69"	69"	81"	81"	93"	93"
Brush diameter	32"	32"	32"	32"	32"	32"
Sweeping width	60"	60"	72"	72"	84"	84"
Width at 30° angle	53"	53"	64"	64"	76"	76"
Mounting system	Skid steer	Skid steer	Skid steer	Skid steer	Skid steer	Skid steer
Brush material	Poly	Poly / Wire	Poly	Poly / Wire	Poly	Poly / Wire
Hyd. motor rating	16 GPM	16 GPM	16 GPM	16 GPM	16 GPM	16 GPM
Sprinkler system	Opt.	Opt.	Opt.	Opt.	Opt.	Opt.
Dirt deflector	Opt.	Opt.	Opt.	Opt.	Opt.	Opt.
Weight	640 lb	640 lb	740 lb	740 lb	840 lb	840 lb



SNOW BLADE

Skid Steer and Euro Mount

SNOW BLADE

PRODUCT OVERVIEW

Constructed for residential and commercial snow removal

25 - 80 hp recommended horsepower

FEATURES

10 gauge blade thickness

7 and 9 foot models have 5 degree oscillation

2 extension trip springs

OPTIONS

Hydraulic angle kit

Crossover release valve

THE EXTREMELY VERSATILE ALLIED BY FARM KING SNOW BLADE CAN COME EQUIPPED FOR A FRONT END LOADER OR SKID STEER CONFIGURATION.

The snow blade is constructed using 3/8 inch by 6 inch cutting blade. Furthermore, the cutting edge is reversible to extend the overall life of the blade. At each end of the blade are adjustable skid shoes for a precise blading depth.

[1] Dual acting cylinder hydraulics provide hands free angle adjustment. **[2]** The 5 degrees of oscillation allows the blade to contact uneven surfaces.

SPECIFICATIONS

MODEL >>	W6021S	W7221S	W9027E	W9027S	W10827E	W10827S
Overall width	60"	72"	90"	90"	108"	108"
Overall height	21"	21"	27"	27"	27"	27"
Moldboard thickness	10 gauge	10 gauge	10 gauge	10 gauge	10 gauge	10 gauge
Cutting edge	3/8" x 6"	3/8" x 6"	3/8" x 6"	3/8" x 6"	3/8" x 6"	3/8" x 6"
Lateral oscillation	n/a	n/a	5°	5°	5°	5°
Manual angle positions	5	5	5	5	n/a	n/a
Skid steer mount	Universal	Universal	n/a	Universal	n/a	Universal
Adjustable skid shoes	Standard	Standard	Standard	Standard	Standard	Standard
Horsepower range	up to 40 hp	up to 40 hp	30 - 80 hp	30 - 80 hp	40 - 95 hp	40 - 95 hp
Weight	334 lb	350 lb	555 lb	530 lb	665 lb	690 lb

REAR BLADE

PRODUCT OVERVIEW

Constructed for ditching, scraping, landscaping and snow removal

Category I, II and III

15 - 150 hp required

FEATURES

Reversible / replaceable cutting edge

No tools are required for adjusting the angle

Pivot Pin designed with tight tolerances

OPTIONS

Hydraulic angle adjustment, Series 60



REAR BLADE

Series 30, 45, 60, 80, 100, 155



PRECISION ENGINEERED

These rear blades have been precisely built, with particular attention to the pivot point. To minimize metal-on-metal wear and maximize blade longevity, the pivot point has been designed with tight tolerance and built to those specifications.

ADJUSTMENT

The manual tilt adjustment on the 45 Series tilts the blade up to 15°. The same bolts adjust the sideshift feature to

move the blade up to 12" off-center. Tilt on the 30 and 60 Series is adjusted on the 3-point hitch.

CUTTING EDGE

Allied by Farm King rear blades feature a reversible and replaceable cutting edge.

STANDARD EQUIPMENT

Allied Rear Blades are quick hitch compatible and the parking stand is standard equipment.



ALLIED BY FARM KING HAS BEEN BUILDING A WIDE VARIETY OF REAR BLADES FOR SEVERAL DECADES.

These blades are manufactured using more steel, which adds strength, longevity and durability to each blade. Available in five series suitable for tractors ranging from 15 hp to 150 hp, Allied by Farm King Rear Blades are capable of tackling tough scraping projects.

[1] Manual or hydraulic offset adjustment is available on 80 Series and larger. **[2]** Adjusting the angle on models without hydraulic cylinders does not require tools. **[3,4]** The manual tilt adjustment on the 45 Series tilts the blade up to 15°. The same bolts adjust the sideshift feature.



SERIES																		
MODEL	3048	3060	3072	4560	4572	4584	6084	6096	8084	8096	80108	10096	100108	15596	155108	155120	155144	
Maximum hp	30	30	30	45	45	45	60	60	80	80	80	100	100	155	155	155	155	
3-point hitch	Category I			Category I			Category I & II		Category II			Category II & III		Category II & III				
Moldboard thickness	1/4"			1/4"			1/4"		1/4" Boxed reinforcement			5/16" Boxed reinforcement						
Moldboard width	48"	60"	72"	60"	72"	84"	84"	96"	84"	96"	108"	96"	108"	96"	108"	120"	144"	
Moldboard height	12 1/2"			13"			16"		18"			18"		21.25"				
Adjustment	Manual 5-position			Manual 5-position			Manual 5-position		Manual or hydraulic			Manual or hydraulic		Manual or hydraulic				
Adjustment, angle	30° left or right			40° left or right			40° left or right		30° left or right			30° left or right		30° left or right				
Adjustment, tilt	3-point hitch linkage adj.			Manual 15° blade adjustment			3-point hitch linkage adj.		Manual or hydraulic 13° blade adjustment									
Offset	N/A			N/A			N/A		Manual or hydraulic 20° left or right									
Sideshift	N/A			Up to 12" off center			N/A		N/A			N/A		N/A				
King pin	N/A			N/A			N/A		3"			3 1/2"		4"				
Cutting edge	1/4" x 3" reversible			High carbon 1/2" x 6" reversible						High carbon 1/2" x 6" reversible								
Weight, lb	130	155	180	263	283	289	405	450	939	969	989	1287	1352	1683	1710	1749	1846	
Dual gauge wheel kit	N/A			N/A			N/A		Optional			Optional		Optional				
Skid shoes	N/A			N/A			N/A		Optional			Optional		Optional				
Racket jack	N/A			N/A			N/A		Optional			Optional		Optional				

Series 30

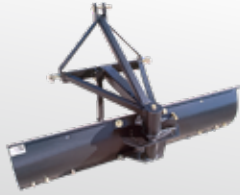

FOR TRACTORS 15-30 HP

Available in 4', 5' and 6' widths. Manual adjustment. Tilt adjustment is 3-point hitch linkage adjustment.

SERIES	30
3-point hitch	Cat. I
Angle	30° left or right
Angle - forward	5-position
Angle - reverse	5-position

Series 45

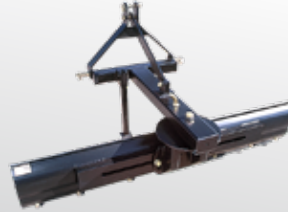

FOR TRACTORS 20-45 HP

Available in 5', 6' or 7' widths. 15° vertical tilt on both sides. Cutting edge constructed of high carbon steel, 1/2" x 6".

SERIES	45
3-point hitch	Cat. I
Angle	40° left or right
Angle - forward	5-position
Angle - reverse	5-position

Series 60

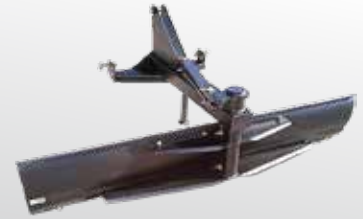

FOR TRACTORS 30-60 HP

Available in 7' and 8' widths. Mechanical linkage. Hyd. adjustment is optional. Cutting edge constructed of high carbon steel, 1/2" x 6".

SERIES	60
3-point hitch	Cat. II, I optional
Angle	40° left or right
Angle - forward	5-position
Angle - reverse	5-position

Series 80



FOR TRACTORS 80 HP

Available in 7', 8' and 9' widths. Angle adjustment, offset and tilt can be fitted with either hydraulic cylinders or mechanical linkage.

SERIES	80
3-point hitch	Cat. II
Angle	30° left or right
Angle - forward	5-position
Angle - reverse	5-position

Series 100



FOR TRACTORS 100 HP

Available in 8' and 9' widths. Hydraulic angle adjustment, offset and tilt. Cutting edge constructed of high carbon steel, 1/2" x 6".

SERIES	100
3-point hitch	Cat. II and III
Angle	30° left or right
Angle - forward	5-position
Angle - reverse	5-position

Series 155



FOR TRACTORS 150 HP

Available in 8', 9', 10' and 12' widths. Hydraulic angle adjustment, offset and tilt. Cutting edge constructed of high carbon steel, 1/2" x 6".

SERIES	155
3-point hitch	Cat. II and III
Angle	30° left or right
Angle - forward	5-position
Angle - reverse	5-position

Standard A Frame



For loader models 395, 495, 595, 695, 2495, 2595, and 2596. Brackets also available to fit most non-Allied loaders. Ideal for round bales.

Specifications	
Weight	490 lb
No. of spears	1
Spear lengths	32" / 49"

Regular A Frame

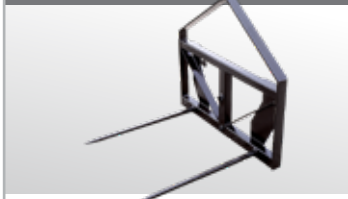

For loader models 395, 495, 595, 695, 795, 2495, 2595, 2596, 2795HD and 2895. Available in skid steer and Euro style models.

SERIES	95 Series	Midmount 2000	Skid Steer
Weight	254 lb	222 lb	329 lb
No. of spears	1-3	1-3	1-3
Spear lengths	32" / 49"	32" / 49"	32" / 49"

Heavy-duty A Frame



60" for loader models 595, 695, 795, 895, 2595, 2596, 2795HD and 2895. Specifically designed for round or square bales. 75" model specifically designed to handle 6' plus diameter round bales.

SERIES	60"	75"
Weight	310 lb	350 lb
No. of spears	1-3	1-3
Spear lengths	32" / 49"	32" / 49"

Pallet Fork A Frame Kit



Available for all loader models and designed to fit on all 'A' frame models. Forks available in 48" (4,400 lb capacity) and 42" (2,000 lb capacity) sizes.

SERIES	60"	75"
Weight	690 lb	730 lb

Standard Bucket



Available in 48", 60", 72", 84", 96" and 100". Capacities range from 6.3 cu. ft. up to 1.19 cu. yd.

SERIES	95 Series	Midmount 2000
Weight	490 lb	510 lb

Large Capacity/Snow Bucket

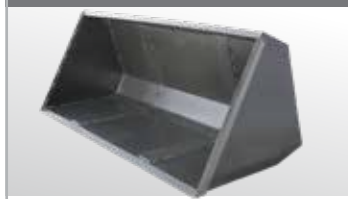

Available in 84" and 100" sizes. Capacities range from 1.35 cu. yd. up to 2.25 cu. yd.

SERIES	95 Series	Midmount 2000
Weight	905 lb	980 lb

C2000 Series Grapple



Comes standard with 84" cross tube to fit on 84" and larger standard and large capacity buckets. Also designed for 85" manure bucket with ten tines as shown here.

Model	C2000	C2062
Weight	565 lb	565 lb

C3000 Series Grapple



Grapple comes standard with 84" cross tube to fit on 84" and larger standard and large capacity buckets. Specifically designed to handle 6' plus diameter round bales.

Series	C3000	C3001
Weight	785 lb	801 lb

Square Bale Stacker Frame



For loader models 895, 2495, 2595, 2596, 2795HD and 2895. Install up to 8 additional stabilizer spears. Telescopic extension kit - for up to 3 square bales at a time.

SERIES	95 Series	Midmount 2000
Weight	440 lb	400 lb
No. of spears	1-4	1-4
Spear lengths	32" / 49"	32" / 49"

Round Bale Squeeze



For loader models 395, 495, 595, 695 and 795.

SERIES	4872
Bales	4' - 6'
Rated	2,200 lb

Skid Steer Adapter Plate



For loader models 95, 195, 295, 395, 495, 595, 2095, 2195, 2295, 2395, 2495, 2595 and 2596. Allows the user to pick up any skid steer attachment.

SERIES	Skid Steer
Weight	120 lb

Ballast Box

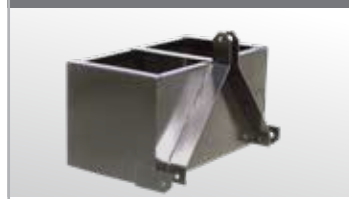

For loader models 95, 2095, 195 and 2195. Provides weight to the rear axle, which in turn increases the stability and traction of your tractor.

SERIES	95 Series	Midmount 2000
Weight	57 lb	57 lb

www.farm-king.com



1260 Clarence Avenue
Winnipeg, Manitoba Canada R3T 1T2
Ph.: 204.661.8711 | Fax: 204.654.2503
Toll Free: 888.524.1003
E-mail: info@buhler.com
farm-king.com

Equipment shown is subject to change without notice. ©2018 Buhler Trading Inc.
Printed in Canada. TTSX:BUI Ref: 11/18

bühler | a division of Buhler Industries Inc.