

4-Auger TMR Mixers

BOTEC®

4100 / BTC 100



www.KuhnNorthAmerica.com



Invest in Quality®

BOTEC® TMR MIXERS 4100 / BTC 100

MAXIMIZE EFFICIENCY AND FEEDING PERFORMANCE



FAST, THOROUGH MIXING

The unique design of our Botec mixers eliminates dead spots for consistent, thorough mixing. The efficient material flow also results in fast mixing and a quick, complete cleanout, saving you time and money.

LOWER COST OPERATION

A lower horsepower requirement compared to competitive models means less fuel consumption. This means significant cost savings to improve your bottom line!

RATION FLEXIBILITY

Whether you're feeding a higher roughage dairy ration or a feedlot ration with higher levels of grain and byproducts, you can tailor your machine with features and options to best meet your needs.

BOTEC® TMR MIXERS in brief



Models	Mixing Capacity	Mixing Capacity w/ Belt Extension	Available Configurations
4136	360 cu. ft.	410 cu. ft.	Stationary, Truck or Trailer
4142	420 cu. ft.	480 cu. ft.	Stationary, Truck or Trailer
BTC 155	550 cu. ft.	630 cu. ft.	Truck or Trailer
BTC 163	630 cu. ft.	720 cu. ft.	Truck or Trailer
BTC 172	720 cu. ft.	810 cu. ft.	Truck or Trailer
BTC 190	900 cu. ft.	1,000 cu. ft.	Truck or Trailer

THE BOTEC® ADVANTAGE: FAST, VERSATILE & CONSISTENT

A QUALITY RATION AND COMPLETE CLEANOUT

The raised lower right auger configuration, along with the close tolerance between the auger flighting and the auger troughs, results in a fast and complete cleanout. The offset upper right auger in combination with the raised lower auger requires less horsepower and provides a faster mix time.

MIX FULL OR PARTIAL LOADS

Due to the cross-mixing action of horizontal auger mixers, Botec TMR mixers can properly mix batches that fill only a portion of the mixing tub providing you with the versatility to mix any size ration.

EVEN, CONSISTENT DISCHARGE

The close auger tolerances and raised lower auger design provide a fast, consistent discharge from beginning to the end of unloading. This results in even feed placement across the entire length of the bunk without a delay for mixer cleanout.

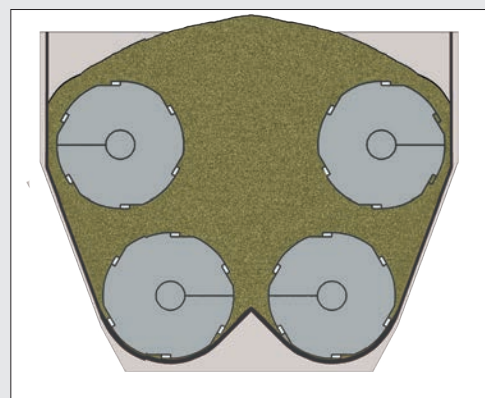
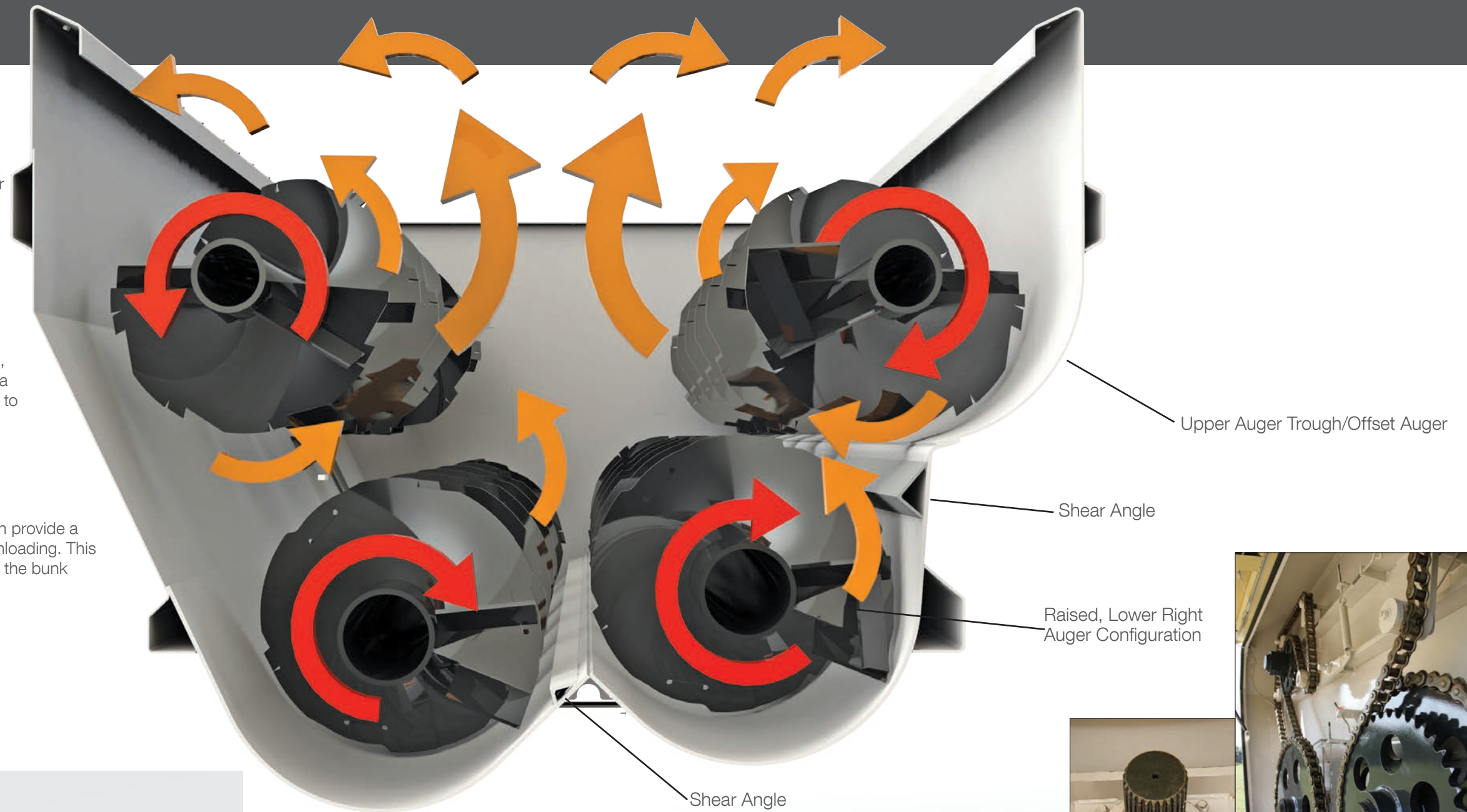

COMPETITIVE MIXERS

Having parallel lower augers creates more force between the augers without increasing mixing capability. Parallel augers also do not transition the feed from right to left as well as if the right auger was raised. This design leads to slow, incomplete cleanout, decreases the mixer's processing ability and increases the horsepower requirements.



SPLINED DRIVE SHAFTS

The splined shafts allow a strong, reliable torque transfer and provide easier sprocket alignment and maintenance.

OUTSTANDING RELIABILITY & PERFORMANCE

The 4136 and 4142 are designed for small- to mid-sized cattle operations with features to provide reliable, efficient and affordable mixing. The drive system, undercarriage, box construction and weight bar system have outstanding serviceability and reliability. However, one fact remains the same, the overall superior mixing performance of this machine stands out from the competition. You get genuine KUHN Knight quality with an innovative and streamlined design, durable components and a rugged build to help ensure reliability and long life.



REDEFINING COMMERCIAL QUALITY

The BTC 100 Series Botec Commercial 4-auger mixers are ideal for large dairy and feedlot operations. They provide the ultimate ration flexibility to thoroughly mix a wide range of ingredients, including high percentages of byproducts or roughages. The unique Botec design eliminates dead spots for efficient material flow and fast mixing to save you time. A lower horsepower requirement, compared to competitive models, results in less fuel consumption. Redesigned discharge options provide fast, even feedout and enhanced reliability from the upgraded auger drive.



DISCHARGE DOOR & LINKAGE

The discharge door frame is more rigid and less complex for dependable day-in and day-out operation.



NYLON AUGER BEARINGS

Reliable, externally mounted nylon bearings provide simple maintenance with reduced sensitivity to contamination.

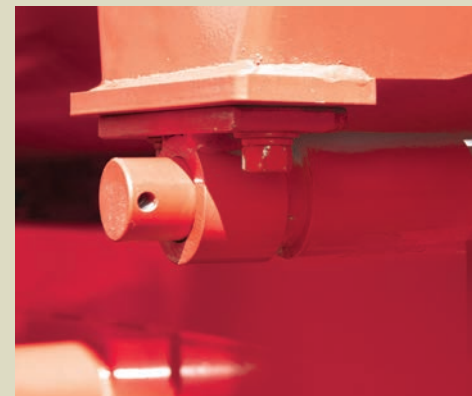

4-POINT WEIGH BAR SYSTEM

Four-point weigh bar system comes standard as a cost-effective and simple weighing system, yet still maintains 99.5% accuracy.



UPGRADED TRAILERS

The BTC 100 Series mixers feature the proven bogie axle design that provides reliable service and a solid foundation to carry the mixer. Single and tandem axle options, as well as multiple tire options, allow the mixer to be set up to meet your specific needs.



FRONT IDLER BEARINGS

Ball bearings provide the durability needed to support the heavy loads and extreme duty cycles faced in large feedlot and dairy applications, and include heavy seals to prevent contamination.



4-POINT LOAD CELL SYSTEM

4-point compression type load cell system comes standard with a heavy-duty check system to ensure long life while maintaining 99.9% accuracy.

RUGGED, DEPENDABLE DRIVE

The drive on the BTC 100 Series mixers has been completely redesigned from previous generations to even better handle the torque experienced under the heaviest of commercial loads. This includes upgraded planetary gearboxes and a heavy-duty roller chain operating in a fully enclosed oil bath.

Splined shafts and sprockets, along with bolted auger flanges provide a strong connection and positive power transfer. Heavy-duty bearings are mounted on the outside of the mixing chamber for easy service and long life.



EASY ACCESS DOOR

The single-handed latch provides easy access to the oil bath. An improved seal keeps oil in, and dirt and debris out, to help minimize wear on drive components and maintain a cleaner appearance.

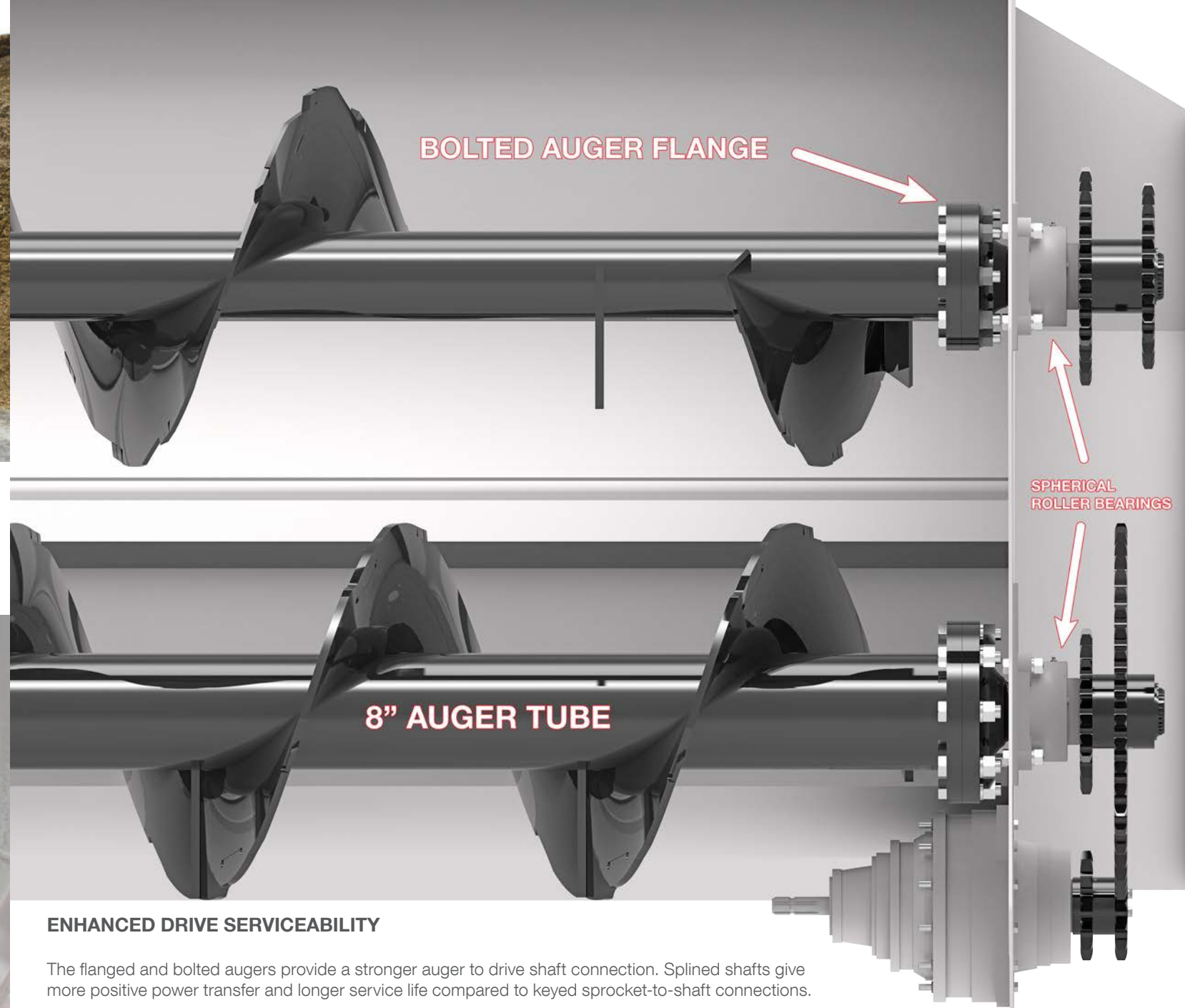
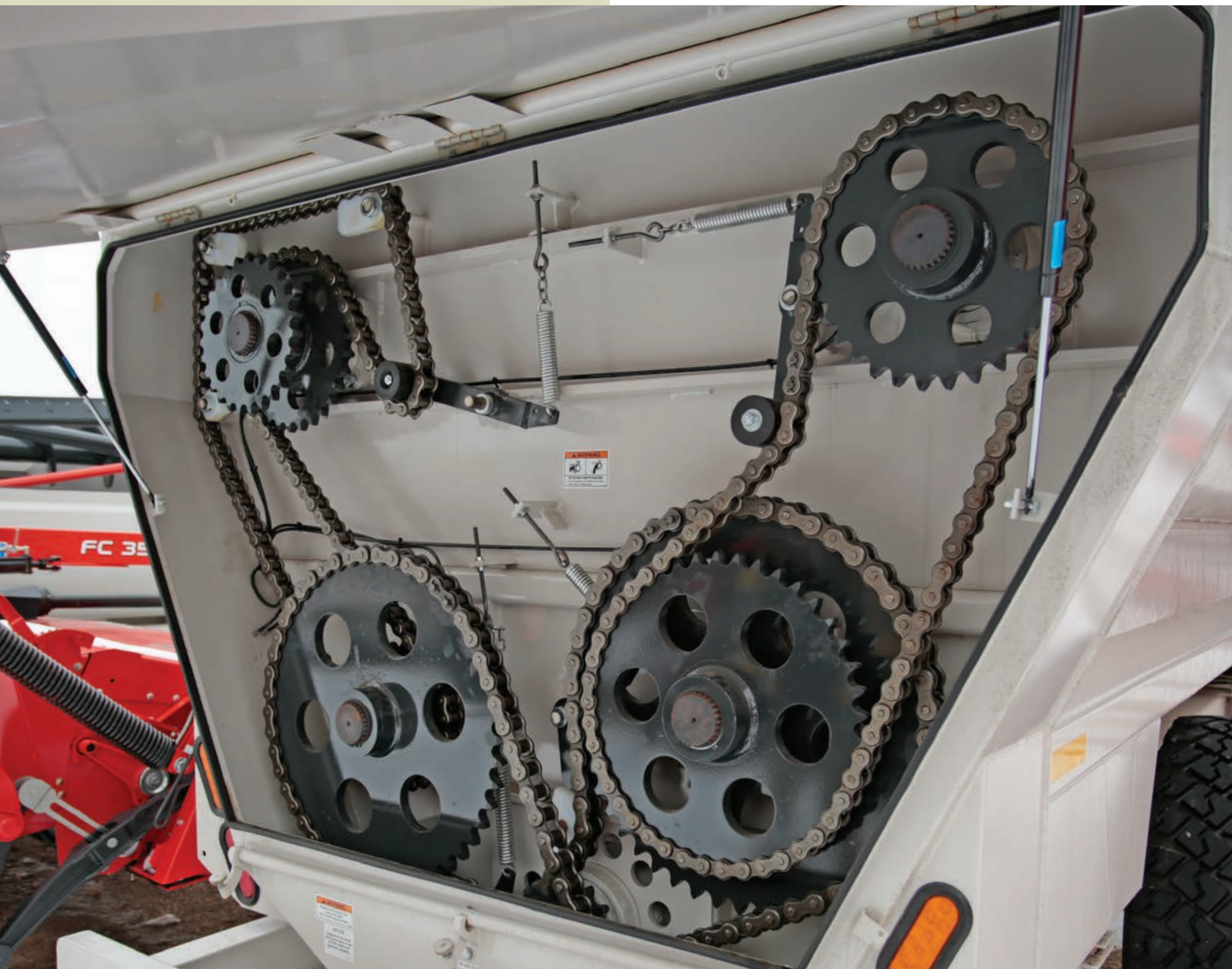

ENHANCED DRIVE SERVICEABILITY

The flanged and bolted augers provide a stronger auger to drive shaft connection. Splined shafts give more positive power transfer and longer service life compared to keyed sprocket-to-shaft connections.

TAILOR YOUR MACHINE TO MEET YOUR RATION'S NEEDS



GRAIN-AUGER OPTION

The grain-auger option provides gentle handling of more delicate feeds like flaked corn to maintain ration quality and prevent fines.



ROUGHAGE-AUGER

The roughage-auger option features notched, sectional flighting with welded-in, self-sharpening, hardened knives for better hay handling.

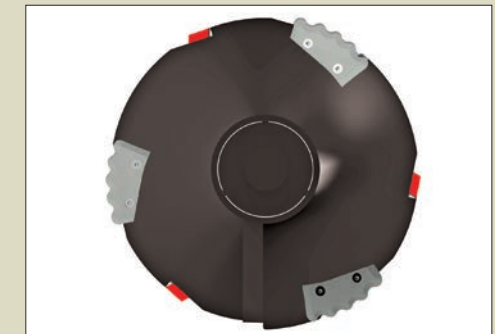

ROUGHAGE MAXX®

With the Roughage Maxx System, scalloped knives are added to the lower augers to maximize hay processing. The knives provide a more consistent particle length and more even blending of the ration.

MULTIPLE DISCHARGE OPTIONS



UNMATCHED EVENNESS OF DISCHARGE

The auger discharge allows adjustment for feeding into higher bunks. It has a simple, hydraulic drive that provides smooth, even discharge and the augers are easy to remove for fast service. Long lasting poly chute liners help prevent rust and limit wear.

Slide tray & chain and slat conveyor discharge options also available on all models.



3-AUGER DISCHARGE

4100 Models Only.

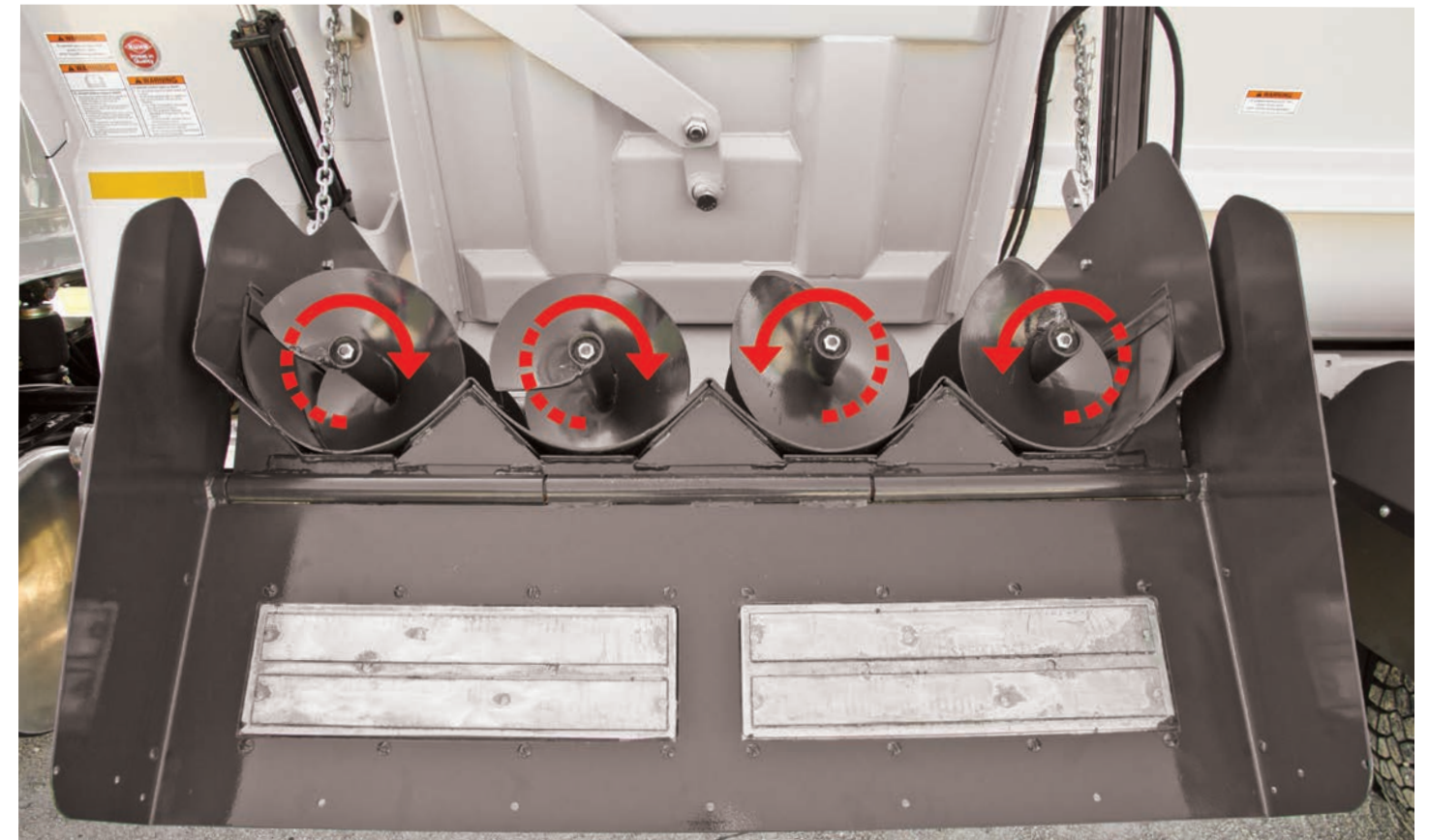

4-AUGER DISCHARGE

Counter-rotating augers bring the feed to the center of the discharge to increase overall capacity and provide a smooth, even discharge for all ration types.

BTC Models Only.



REMOVABLE AUGERS & POLY LINERS

The discharge augers are simple to remove for easy serviceability. Long-lasting, replaceable polyethylene chute liners prevent rust and limit wear.

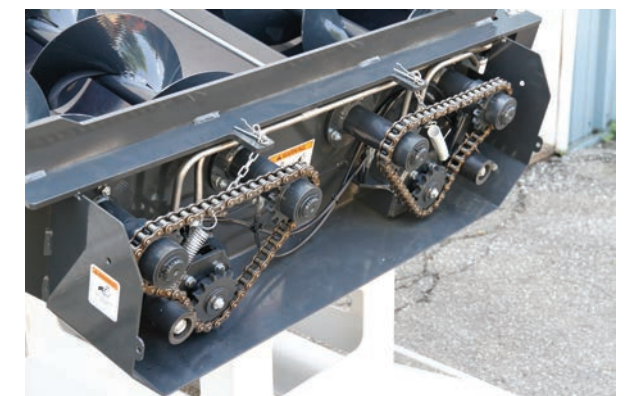

SIMPLIFIED DRIVE

As with the main auger drive, the discharge auger shafts are splined for a more positive power transfer and longer service life. The simplified drive design, featuring only two chains and a remote grease bank, results in easy service and maintenance.

ADDITIONAL OPTIONS

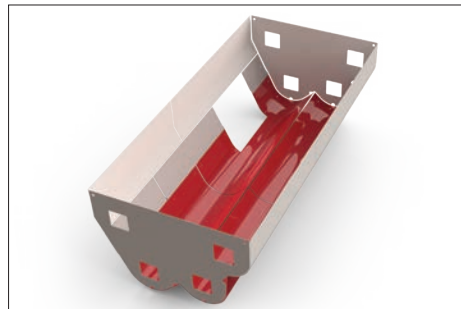

PARTIAL OR FULL STAINLESS STEEL LINER

The partial liner covers the most critical wear areas in the mixer and provides added protection and longer life. The full liner completely covers all of the high wear areas for unmatched dependability and long service life.



ROUGHAGE MAXX®

The Roughage Maxx System incorporates scalloped knives on the lower auger to maximize hay processing. The knives provide a more consistent particle length and more even blending. The result is a more uniform and palatable ration with reduced sorting for improved feed efficiency.



CAPACITY BELT EXTENSION

A belt extension added to the top of the mixing tub increases capacity by about 10%. It also improves hay containment, and the rubber construction is durable and pliable for long life.



SCALE SYSTEMS

Different scale brands, models and options are available for all types of operations, ranging from the very basic to high-end feed-tracking programs that use a remote scoreboard display. Optional remote indicators are available for placement that will allow easier viewing.



GENUINE KUHN PARTS®

No part better fits a KUHN machine than an original KUHN part

Here at KUHN, we produce spare parts built to last in our very own foundries, our forges and our ultra-modern production facilities. You can trust in our longstanding know-how, based on almost two centuries of experience. With KUHN Parts, you can be assured of the highest quality parts and customer service in the agriculture equipment industry. Seven distribution centers, located strategically throughout North America, ensure that KUHN, KUHN Knight and KUHN Krause dealers have access to parts and assistance so you can get back in the tractor.



TRUCK MOUNT OPTIONS

Kuhn North America proudly offers complete factory mounting of mixer to truck chassis. In addition, we are able to alter customer supplied truck chassis to fit your specific feeding needs through modifications in our truck shop.



FULLY CONTAINED HYDRAULIC COMPONENTS

Hydraulic components are contained in a cabinet mounted to the side of the BTC mixers. This cabinet keeps the components clean and protected, while allowing for easy service. On hydrostatic units the oil cooler is also mounted in this cabinet, preventing buildup of debris while allowing maximum airflow.



DRIVE SELECTION FOR MAXIMUM PERFORMANCE



MECHANICAL DRIVE

Due to the low horsepower requirement of the Botec design, a mechanical drive powered by a transmission PTO works well in many feeding situations, at a lower cost than alternative drive options. Mechanical drives are available in a number of different configurations, including front and mid-unit gearbox mounting in order to match up to nearly any truck chassis.

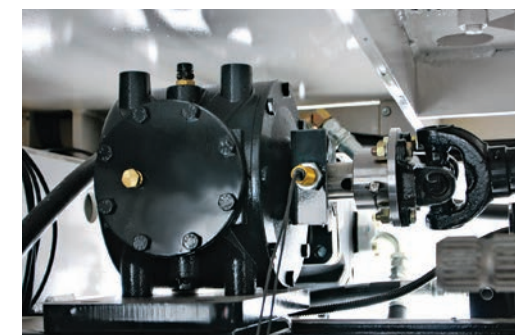

HYDROSTATIC DRIVE

In addition to mechanical drives, the BTC 100 Series is also available with a hydrostatic drive. This hydrostatic system is driven off of either a front engine (FEPTO) or rear engine (REPTO) power take-off. Driven off of the engine instead of transmission, hydrostatic drives allow for the mixer speed to be controlled independent of ground speed. The hydrostatic drives also allow for gentler mixer startup, which is especially important in larger units mixing heavier loads.

Model Specifications

	4136		4142		BTC 155		BTC 163		BTC 172		BTC 190	
DIMENSIONS (Inches)	Trailer	Truck	Trailer	Truck	Trailer	Truck	Trailer	Truck	Trailer	Truck	Trailer	Truck
Overall Length	223"	172"	246"	195"	267"	215"	291"	239"	291"	239"	295"	242"
Mixing Chamber Length	144"		168"		192"		216"		216"			
Overall Height Standard ¹												
- Single Axle - Without Extensions / With extensions	98"	116"	98"	116"	106" / 114"	117" / 125"	106" / 114"	117" / 125"	114" / 122"	125" / 133"	-	136" / 144"
- Tandem Axle - Without Extensions / With extensions	-	116"	-	116"	-	117" / 125"	108" / 116"	117" / 125"	114" / 122"	125" / 133"	130" / 138"	136" / 144"
Tread Width - Single Axle	87"	96"	87"	96"	91"	96"	91"	96"	91"	96"	-	96"
Tread Width - Tandem Axle	-	-	-	-	-	-	106"	-	106"	-	102"	-
Overall Width - Mixer Only	90"				96"				101"			
SPECIFICATIONS												
Unit Weight (lbs) ²	9,400	7,710	10,340	8,650	17,350	16,100	17,600	16,300	18,000	16,650	22,600	17,600
Maximum Net Loads	10,800 lbs		12,600 lbs		18,000 lbs		20,700 lbs		23,700 lbs		29,700 lbs	
Mixing Capacity - Without Extensions	360 cu.ft.		420 cu.ft.		550 cu.ft.		630 cu.ft.		720 cu.ft.		900 cu.ft.	
Mixing Capacity - With Extensions	410 cu. ft.		480 cu. ft.		630 cu.ft.		720 cu.ft.		810 cu.ft.		1,000 cu.ft.	
Lower Augers												
- Flighting Diameter	24"				28"				28"			
- Flighting Thickness - Front / Rear	1/2"				3/4" / 5/8"				3/4" / 5/8"			
- Outside Diameter	5 5/8"				8 5/8"				8 5/8"			
- Wall Thickness	1/2"				1/2"				1/2"			
- Shaft Diameter	3"				3 1/2"				4"			
Upper Augers												
- Flighting Diameter	24"				28"				28"			
- Flighting Thickness	3/8"				3/8"				3/8"			
- Outside Diameter	5 5/8"				6 5/8"				6 5/8"			
- Wall Thickness	1/2"				9/16"				9/16"			
- Shaft Diameter	3"				3 1/2"				3 1/2"			
Box Construction - Material Thickness												
- Auger Bottoms	3/8"				3/8"				3/8"			
- End Panel - Front and Rear	7 GA				7 GA				7 GA			
- Mixing Chamber - Right Side	7 GA				7 GA				7 GA			
- Mixing Chamber - Left Side	7 GA				7 GA				7 GA			
- Door Opening Size - Width x Height	31 1/2" x 32 1/4"				40" x 31"				40" x 31"			
Drive System												
- Planetary	Standard				Comer				Fairfield			
- Roller Chain Drive	100-120				120 - 140H				120 - 140H			
Undercarriage	Single Axle	-	Single Axle	-	Single Axle		Single or Tandem Axle				Tandem Axle	
Hitch	Standard Adjustable Heavy-Duty Clevis				Standard Clevis		Standard Clevis		Standard Clevis		Standard Clevis	
PTO Minimum Requirement (hp) ³	60	-	80	-	100	-	110	-	120	-	130	-
Weigh System	Four-point Weigh Bar System, Junction Box and Power Cord				Four-Point Compression-Type Load Cell System, Junction Box and Power Cord							
Highway Light Kit	Standard				Standard							

¹ Truck dimensions based on 41" truck frame height.

² Heights and widths will vary depending on tire size.

³ Unit is equipped with most common options.

⁴ Horsepower requirement may vary with different materials.

Consult operator's manual for proper tractor sizing.



A KUHN KNIGHT MIXER FOR EVERY OPERATION

Mixers	Complete Rations					Ration Ingredients		
Mixer Type & Model	All haylage, corn silage, concentrates	Up to 20% *dry hay, haylage, corn silage, concentrate	20%-40% *dry hay, haylage, corn silage, concentrate	Over 50% *dry hay, haylage, corn silage, concentrate	Baleage, haylage, corn silage, concentrates	Premixing of concentrates	Round bales (unprocessed)	Square bales (unprocessed)
4-Auger								
Reel								
Vertical								

*Dry hay is good-quality alfalfa hay, both small or large square bales

This chart is a general guideline. Individual rations vary for every operation and will affect your mixer choice.



Best



Good



Not Recommended

Most complete TMR mixer line on the market



1. Single-auger vertical TMR mixers / 2. Twin-auger vertical TMR mixers / 3. 4-auger horizontal TMR mixers / 4. Reel TMR mixers

For more information about your nearest Kuhn Knight dealer and other Kuhn Knight products, visit our website

www.KuhnNorthAmerica.com



Visit our YouTube channel to watch our latest product videos.

KUHN NORTH AMERICA, INC.

Corporate Headquarters
1501 West Seventh Avenue - Brodhead, WI 53520

Your KUHN Knight dealer

www.KuhnNorthAmerica.com

Information given in this document is only for informational purposes and is non-contractual. Our machines are in compliance with North American safety standards. In our literature, and for improved illustration of certain details, some safety devices may not be in operating position. When operating these machines, these devices must be operated in accordance with the requirements indicated in the operator's manuals and assembly manuals. We reserve the right to change any designs, specifications or materials listed without further notice. Machines and equipment in this document can be covered by at least one patent and/or registered design. Trademarks cited in this document may be registered in one or several countries.

Find us on

