

# Instruction Book



# Green Machine Poultry Mortality Composter

---



Manufactured By:  
Helm Welding (1983) Limited  
86386 Lucknow Line  
PO Box 158  
Lucknow, Ontario, Canada  
N0G 2H0  
TEL: (519) 529-7627 or (519) 529-7000  
FAX: (519) 529-3260  
Email: [inquiry@lucknowproducts.com](mailto:inquiry@lucknowproducts.com)  
Website: [www.lucknowproducts.com](http://www.lucknowproducts.com)

---

Documentation © 2017 by Helm Welding (1983) Limited. All rights reserved.

No parts of this manual may be reproduced or transmitted in any form of by any means, electronic or mechanical, including photocopying and recording, or by any information storage retrieval system, without permission in writing from Helm Welding (1983) Limited

Helm Welding (1983) Limited  
86386 Lucknow Line  
PO Box 158  
Lucknow, Ontario, Canada  
N0G 2H0  
Email: [inquiry@lucknowproducts.com](mailto:inquiry@lucknowproducts.com)  
Website: [www.lucknowproducts.com](http://www.lucknowproducts.com)

Printed in Canada 2017

## Warranty Information

Helm Welding (1983) Limited warrants to the original user that goods & equipment of its manufacture are free from defects in material and workmanship under normal use and service from the date of shipment, or where applicable from the date of installation by the dealer for the periods of time indicated below:

- ◆ one year parts & labour for the mixer assembly
- ◆ two years parts & labour for the planetary gearbox

Helm Welding (1983) Limited will, at its option, repair or replace parts (f.o.b. point of shipment) that are found to be defective.

### This warranty is on these further terms and conditions:

1. The equipment must be installed (when applicable), operated and maintained in accordance with Helm Welding's instructions.
2. The equipment will fulfill the function it is designed to perform but due to wide variation in farm animals, management practices on farms and other conditions beyond the equipment manufacturer's control, no specific level of performance is guaranteed.
3. Excluded from the warranty are damages caused by late delivery, ordinary wear and tear, erosion or corrosion, lightning and other acts of God, accident or alteration, repair or attempted repair or adjustments made by persons not authorized by Helm Welding (1983) Limited, by misuse, abuse or improper handling or operation of the equipment by the purchaser or any third party or poor or no servicing of machine.
4. Helm Welding (1983) Limited shall in no event be responsible for any consequential damages of any nature whether special or general, direct or indirect.
5. Equipment, parts or accessories manufactured by others and not sold under Helm Welding (1983) Limited trademark(s) carry the warranty and remedy provided by their manufacturer only.  
***Any gearbox related component that has been opened or tampered with will void the warranty on that component. Do not attempt any repair on any of these items if seeking warranty coverage.***
6. Any warranty or claim, which differs from that herein set out is unauthorized by Helm Welding (1983) Limited and is the warranty solely of the party making it. Helm Welding (1983) Limited makes no other warranty express or implied and the original user's sole remedy for breach thereof is as set forth above.

To properly qualify for warranty, **all maintenance criteria and service schedules must be followed (including oil changes and greasing).**

As well, the pre-delivery check list and warranty registration forms must also have been completed at the time of product delivery and returned to us the manufacturer for proper record keeping. In extreme warranty situations, the service record must be provided to Helm Welding upon request at any time.

**Failure to follow and provide any of the above information will void warranty.**

**The warranty registration card must be completed and mailed within thirty (30) days of delivery or installation of the equipment to validate this warranty.**

Note: Credits or replacements will not be issued unless documentation is complete and correct.

Date of installation \_\_\_\_\_ Serial Number \_\_\_\_\_

Your Luck//Now Dealer \_\_\_\_\_

Name \_\_\_\_\_

Address \_\_\_\_\_

Telephone Number \_\_\_\_\_

This Copy Must  
Be Returned To  
HELM WELDING (1983) LIMITED

Helm Welding (1983) Limited  
P.O. Box 158  
Lucknow, Ontario, Canada  
N0G 2H0

Horizontal Series  
Pre-Delivery Check List & Warranty Registration

- 1. Inspect machine for loosened bolts during transit.
- 2. Inspect machine for loose bearing locking collars.
- 3. Check all roller chains for alignment.
- 4. Check oil in planetary gearbox.
- 5. Grease all bearings and chains.
- 6. Run machine and make sure all functions work properly before delivery to user.
- 7. Fill oil bath with good grade of oil to the center of the chain on the bottom sprocket.
- 8. Check all door fasteners to ensure proper fit.
- 9. Check all electrical connections to make sure they are tight and in place.
- 10. Check to make sure all hydraulic fittings are tight and all hoses are properly held in place.
- 11. Run the hydraulic system to check for leaks and proper function.
- 12. Check oil level of hydraulic unit.
- 13. Check operation of roof.
- 14. Check to make sure all safety equipment is in place.

Dealer Signature: \_\_\_\_\_ Date: \_\_\_\_\_

Client Signature: \_\_\_\_\_ Date: \_\_\_\_\_

Client Address: \_\_\_\_\_  
\_\_\_\_\_  
\_\_\_\_\_  
\_\_\_\_\_

Model # \_\_\_\_\_ Serial # \_\_\_\_\_

HELM WELDING (1983) LIMITED  
86386 Lucknow Line  
PO Box 158  
Lucknow, Ontario, Canada  
N0G 2H0

ATTENTION:  
Technical Customer Service

Tel: (519) 529-7627 or (519) 529-7000  
Fax: (519) 529-3260

Number of pages \_\_\_\_\_  
including front-page \_\_\_\_\_

**Reader's comments**

Helm Welding (1983) Limited is committed to providing excellent documentation. Please, fax or write us your comments on this manual.

Your suggestions help us improve our technical information.

**General**

Please check appropriate square.

Agree    Disagree

- |                          |                          |                                       |
|--------------------------|--------------------------|---------------------------------------|
| <input type="checkbox"/> | <input type="checkbox"/> | * I can find the information I want   |
| <input type="checkbox"/> | <input type="checkbox"/> | * The table of contents is thorough   |
| <input type="checkbox"/> | <input type="checkbox"/> | * Instructions are complete           |
| <input type="checkbox"/> | <input type="checkbox"/> | * There are enough illustrations      |
| <input type="checkbox"/> | <input type="checkbox"/> | * Illustrations are clear and helpful |

**Comments:**

---

---

---

---

---

**Name & Address**

---

---

## Important Information

This manual has been prepared to provide the owner and operator with the information required to properly operate and maintain his unit. It is important that you, the owner or operator, read this manual prior to operating or performing any maintenance work on the unit. This manual is for all mixer models.

Date of purchase: \_\_\_\_\_

Serial Number: \_\_\_\_\_

Information needed for ordering parts.

Model Number: \_\_\_\_\_

Planetary Gearbox: Type \_\_\_\_\_ Ratio \_\_\_\_\_

Serial # \_\_\_\_\_ Date \_\_\_\_\_ Code \_\_\_\_\_

Special Options: \_\_\_\_\_  
\_\_\_\_\_  
\_\_\_\_\_  
\_\_\_\_\_

## Table of Contents

1. Safety .....	1
2. Assembly .....	6
3. Mixer Loading .....	8
4. Mixer Operation.....	9
5. Maintenance.....	11
Roller Chain .....	11
Determination of Chain Wear.....	12
Installing New Chain.....	13
Sprocket Inspection .....	13
Grease Bearings.....	13
Planetary Gearbox .....	14
Rear Drive Compartment.....	15
Door Adjustment .....	15
6. Maintenance Schedule .....	16
Service Record* .....	17
7. Lubrication Specifications .....	18
Appendix - Mixer Requirements.....	19

## 1. Safety

### SAFETY TIPS!

TAKE NOTE! THIS SAFETY ALERT SYMBOL FOUND THROUGHOUT THIS MANUAL IS USED TO CALL YOUR ATTENTION TO INSTRUCTIONS INVOLVING YOUR PERSONAL SAFETY AND THE SAFETY OF OTHERS. FAILURE TO FOLLOW THESE INSTRUCTIONS CAN RESULT IN INJURY OR DEATH!



THIS SYMBOL MEANS

ATTENTION!

BECOME ALERT!

YOUR SAFETY IS INVOLVED!

**DANGER:** Indicates an imminently hazardous situation that, if not avoided, will result in death or serious injury. They are limited typically to hazards, which cannot be guarded for functional purposes.

**WARNING:** Indicates a potentially hazardous situation that, if not avoided, could result in death or serious injury, and includes hazards that occur when guards are removed. Also used to alert against unsafe practices.

**CAUTION:** Indicates a potentially hazardous situation that, if not avoided, may result in minor or moderate injury. It may also be used to alert against unsafe practices.

If you have any questions not answered in this manual or require additional copies or the manual is damaged, please contact your dealer or

Helm Welding (1983) Limited, PO Box 158 Lucknow, Ontario Canada, N0G 2H0.  
TEL: (519) 529-7627 or (519) 529-7000  
FAX: (519) 529-3260  
EMAIL: [inquiry@lucknowproducts.com](mailto:inquiry@lucknowproducts.com)





## Equipment Safety Guidelines

Safety of the operator is one of the main concerns in designing and developing a new piece of equipment. Designers and manufacturers build in as many safety features as possible. However, every year many accidents occur which could have been avoided by a few seconds of thought and a more careful approach to handling equipment. You, the operator, can avoid many accidents by observing the following precautions in this section. To avoid personal injury, study the following precautions and insist that those working with you follow them.

In order to provide a better view, certain photographs or illustrations in this manual may show an assembly with a safety shield removed. However, equipment should never be operated in this condition. **Keep all shields in place.** If shield removal becomes necessary during repairs, replace the shield prior to use.

Replace any **CAUTION, WARNING, DANGER** or instruction safety decal that is not readable or is missing.

Do not attempt to use this equipment under the influence of alcohol or drugs.

Review the safety instructions with all users annually.

This equipment is dangerous to children and persons unfamiliar with its operation. The operator should be a responsible adult familiar with farm machinery and trained in this equipment's operations. **Do not allow persons to operate or assemble this unit until they have read this manual and have developed thorough understanding of the safety precautions and how it works.**

Do not paint over, remove or deface any safety signs or warning decals on your equipment. Observe all safety signs and practice the instructions on them.

\*Never exceed the limits on a piece of machinery. If its ability to do a job, or to do so safely is in question - **DO NOT TRY IT!\***



## Safety Sign Care

- Keep safety signs clean and legible at all times.
- Replace safety signs that are missing or have become illegible.
- Replaced parts that displayed a safety sign should also display the current sign.
- Safety signs are available from your Distributor or the factory.

### **How to install safety signs:**

- Be sure that the installation area is clean and dry.
- Decide on the exact position before removing the backing paper.
- Remove the smallest portion of the split backing paper.
- Align the decal over the specified area and carefully press the small portion with exposed sticky backing in place.
- Small air pockets can be pierced with a pin and smoothed out using the piece of decal backing paper.



### Before Operation

- Carefully study and understand this manual.
- Do not wear loose-fitting clothing that may catch in moving parts.
- Always wear protective clothing and substantial shoes.
- It is recommended that suitable protective hearing and eye protection be worn.
- Give the unit a visual inspection for any loose bolts, worn parts or cracked welds, and make necessary repairs. Follow maintenance safety instructions included in this manual.
- Make sure there are no tools lying on or in the unit.
- Do not use the equipment until you are sure that the area is clear, especially of children and animals.
- Because it is possible that this equipment may be used in dry areas or in the presence of combustibles, special precautions should be taken to prevent fires and fire fighting equipment should be readily available.
- Don't hurry the learning process or take the unit for granted. Ease into it and familiarize yourself and other operators with its operation before use.



### During Operation

- Beware of bystanders, particularly children! Always look around to make sure that it is safe to start the unit.
- Keep hands and clothing clear of moving parts.
- As a precaution, always recheck the hardware on equipment following every 100 hours of operation. Correct all problems. Follow procedures.

Before operating the mixer, carefully read the instructions in the following chapters. Proper handling of the equipment is the basis of trouble-free use. The equipment must be used only for the intended application.



**SW1:** Proper handling of the equipment is the basis of trouble-free functioning. The equipment **MUST** be used **ONLY** for intended use.

	<b>WARNING</b>
	<p>To Prevent Serious Injury or Death</p> <ul style="list-style-type: none"> <li>• Avoid unsafe operation or maintenance.</li> <li>• Do not operate or work on this machine without reading and understanding the operator's manual.</li> <li>• If manual is lost, contact your nearest dealer for a new manual.</li> </ul> <p style="text-align: right; font-size: small;">SW1</p>



**WARNING**  
Turning gears, chains and augers can cause serious injury. To avoid injury, keep hands, loose clothing and jewelry away from the mixer while operating.

<b>DANGER</b>	
<p>To Prevent Serious Injury Or Death From Moving Parts:</p> <ul style="list-style-type: none"> <li>• <b>KEEP AWAY</b>, Moving parts can crush and dismember.</li> <li>• Do not operate without guards and shields in place.</li> <li>• Disconnect and lockout power source before adjusting and servicing.</li> </ul> <p style="text-align: right; font-size: small;">SW108</p>	



**SW108:** Keep chain drive guards closed when operating. STOP unit to lubricate.



**SW103:** Mixing Augers are very dangerous - NEVER climb at the top of the mixer. Only add items to the mixer by hand while firmly standing on the platform. NEVER lean over the edge of the mixer while on the platform.



**SW205:** Do not raise/lower the mixer roof unless all personnel are clear. Do not open or close the discharge door unless all personnel are clear.



## 2. Assembly

When installing the unit, it is important that the mixer is level and on a solid surface.

Install all stands to the mixer and securely tighten all stand mounting bolts.

Helm Welding recommends anchoring the stands to the ground as well.

*Ensure that the cover lid has adequate clearance above to open fully (no electrical wires, tree branches or other obstructions above it)*

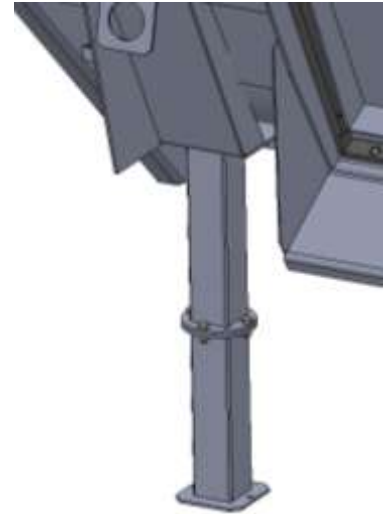

Ensure both roof hydraulic cylinders are moved into their proper position and all cylinder pins are secured into place. Ensure all hydraulic fittings and hoses are tight and not damaged during transit.



Set the stair platform onto the two mounting angles on the front of the mixer. Securely bolt the platform in place. Do not stand on the platform until the bolts are secure.

Helm Welding recommends anchoring the platform to the ground as well.



The unit runs on 220 volt single phase electrical power. Have a licensed electrician connect power to the disconnect plug coming out of the control panel of the mixer. All connections inside the control panel are already completed.

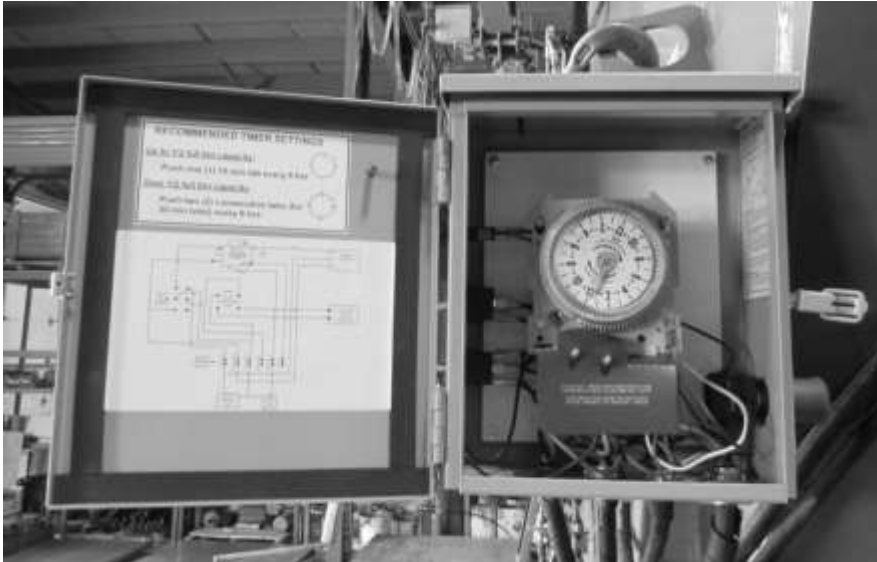

Before operating for the first time make sure the hydraulic power unit, planetary gearbox and rear drive compartment have sufficient oil (see the maintenance section of the manual).



### 3. Mixer Loading



**Note:** When loading items manually, never climb above the side of the mixer. You could fall into the processing chamber while the unit is running causing serious injury or death.



**Critical Safety Item :** DO NOT ATTEMPT TO OPEN LID WITH MORE THAN 1-2 INCHES OF SNOW ACCUMULATION. FIRST REMOVE EXCESS SNOW ACCUMULATION BEFORE ATTEMPTING TO OPEN COVER LID AND LOAD MATERIALS

NEVER ATTEMPT TO OPEN THE LID WHEN IT IS VERY WINDY OUTSIDE.

#### Opening/Closing Cover Lid

On the control panel, turn on the hydraulic unit. Then operate the appropriate hydraulic lever to open the lid to the desired height.

Always check to make sure no one is on the viewing platform BEFORE attempting to *close* the Cover Lid.

To close the Cover Lid after loading materials, operate the appropriate hydraulic lever. Always be aware of any persons or objects around the machine when opening or closing to prevent accidental damage. There is no warranty for damage caused by operator error.

Turn off the hydraulic unit (on the control panel) when the lid is closed.



To load larger amounts of materials for mixing & composting, the cover lid must be opened. Always check overhead to see if there is any obstruction that the cover lid may contact when opening.

Alternatively, for smaller amounts of material being added, the manual hatch in the lid can be opened and material can be dumped in by hand without opening the cover lid. Climb to the top of the stair platform, open the manual hatch and dump through the opening. Be sure to close the hatch when done. *Keep fingers clear of the hatch opening when closing the hatch.*

*In order for proper composting activity to occur, the cover lid must be closed, always close the lid after loading.*

## 4. Mixer Operation

Proper mortality composting is a complicated process involving several components and influenced by many factors (some of which include climate, operator management of input ingredients & moisture). **The following information is a guideline only.** Trial and error is the only method that will determine what works best for your practice.

### Initial Ingredients

In order to initially achieve composting activity you need to have a proper ratio of deadstock to carbon source. Carbon source normally consists of a mixture of uncompressed wood shavings (sawdust is not suitable) and manure. A general guideline is to have an equal volume of deadstock to carbon source in the mixer. The proper ratio will only be determined by your operation and materials. A good volume to start with to begin compost activity is a total volume of 30 cubic feet (approx. 1 cubic yard) in the mixer (15 cubic feet of deadstock, 15 cubic feet of carbon source).

### Loading Operation

Raw materials may be loaded by hand using the stairs/viewing platform. Alternatively, use a loader tractor to dump in larger quantities of materials. **Always be sure red “E-stop” button is depressed BEFORE attempting to load materials. NEVER ENTER MIXING CHAMBER.**

The mixer/composter is designed to provide maximum efficiency when loaded from 40% to 90% of the total volume. Overloading the unit will decrease the efficiency of the mixing & composting action. One characteristic of an overloaded unit is that material is forced over the front or the lid contacts material when closing. **Always load raw materials to the front end of the mixer to allow the material to fall in the rear when mixing.** Close Cover Lid following the instructions noted in section 3.

### Mixing Operation

After loading initial or additional raw materials, the “MIX” switch should be set to “Hand” position for 5 to 10 minutes. **ALWAYS CHECK TO BE SURE THAT THE TEMPERATURE PROBE HAS BEEN REMOVED FROM THE DISCHARGE DOOR BEFORE SETTING THE ‘MIX’ SWITCH TO “HAND” OR “AUTO” POSITION. FAILING TO REMOVE THE PROBE BEFORE TURNING ON MIXER DRIVE MOTOR WILL DESTROY THE TEMPERATURE PROBE.**

After running unit in “Hand” position for 5 to 10 minutes to mix in new materials, the mixer should be set to the “Auto” timer mode.

To make adjustments to the timer setting, disconnect power to the control panel, then open the control panel door. *The control panel is wired for 220 volts, never make any adjustments in the panel with the power connected.*

*If the green light is on dimly there is still power in the control panel.*

*Depressing an ‘E-stop’ button will disconnect power to the control panel (the green light will be off), or disconnect the main power source.*

Set the timer for the desired mixing interval (a guideline is below):

Up to ½ full bin capacity - the mixer should operate for 15 minutes every 6 hours

Over ½ full bin capacity - the mixer should operate for 30 consecutive minutes every 6 hours

The timer is factory preset to run 15 minutes every 6 hours.

The timer settings may be adjusted to suit your operation - time of day hydro rates, more suitable running time etc. Trial and error will determine what works best for your operation.

Close the control panel door and reconnect power to the control panel.

Set the “MIX” switch to “Auto”

The green light on the control panel will fully light up indicating that the mixer is powered and will start at the time set on the 24 hour clock. The green panel light is a warning to anyone around the mixer that the drive unit can start at any time.





Once the initial ratio of deadstock to carbon source has been made, normally only deadstock needs to be added after that. If the mix appears too dry, some water can be added. If the mix is too moist, more wood shavings can be added to absorb some moisture.

The final product should be a consistency similar to “black peat moss”. It should be moist, but not wet. The optimal time to view the consistency is right after the mixer has been running for 15 minutes (after the material has been “stirred”). Only view the consistency through the cover lid or hatch – *do not open the side door until you are ready to unload*. Never stick your hands into the mixer tub, use a pail or shovel to remove some product for viewing.

Continue adding deadstock to the mixer during your poultry production cycle. Always shut the mixer off when loading new materials. Every time after loading new materials in the mixer, the “Hand” cycle should be used again for 5-10 minutes, and then changed to “Auto”. Once the mixer is over half full capacity, change the timer to run for 30 consecutive minutes every 6 hours.

Deadstock may be added until you are finished your production cycle, or the mixer is at 90% capacity. Once that has been achieved, set the mixer to the “Auto” position and let the mixer run for a minimum of 3 days without adding any new material. *Make sure the cover lid is closed for this entire time.*

*Never let the mixer sit “idle” (not turning) while material is still in the unit for any more than 24 hours. The corrosiveness of the material while “idle” can damage mixer components. The mixer should be left in the “Auto” setting if any material is in it.*

### Temperature Measurement

*Before taking any temperature readings depress the red “E-stop” button.* Insert the 20” temperature probe in the hole in the discharge door to verify the level of composting activity. **The temperature probe should only be inserted when the green light on the main panel is OFF.** Wait 1 to 2 minutes for an accurate measurement then remove the temperature probe from the hole in the discharge door, reset the red “E-stop” on the control panel.

The guideline indication that it is time to empty the mixer is when temperatures reached are at least 120F consistently, and you have not been adding any new materials for the last 3 days. *Again, this is only a guideline, further mixing time may be required to obtain proper compost material.* Warmer atmospheric temperatures may not require mixing that long, cooler temperatures may require more time. The temperature should be checked and recorded at least twice a day. This will give a guideline for future mixes. The consistency/appearance of the mix should be checked before unloading.

### Unloading Operation

During unloading, the mixing augers must be in operation to move the compost material to the discharge door. This is accomplished by turning on the drive motor for the mixer (set “MIX” switch to “HAND” position).

Turn on the hydraulic power unit, use the appropriate hydraulic lever to open the discharge door to the desired amount to discharge compost.

Close the discharge door all the way to the bottom seal to stop the flow of material. Turn off the hydraulic unit.

It is advisable that the mixer is never entirely emptied. It is suggested to leave a minimum of 30 cubic feet ( approx. 1 cubic yard) of material in the mixer to aid in future composting activity. While the mixer is left with this small amount of material in it, the “auto” setting should be used so the material is stirred regularly.

However, if the mixer is going to sit unused for more than 90 days it is advisable to entirely empty the mixer out. This will require starting the compost activity again using the proper ratio of deadstock to carbon source.

## 5. Maintenance

*Before doing any maintenance in the rear oil bath compartment, always disconnect the power to the control panel to avoid any possible injury.*



### Roller Chain

Roller chain is a dependable means for the transmission of power. For maximum efficiency, anticipate the need for chain replacement. This avoids unexpected delays in operation. Joint wear, overload conditions, metal fatigue or pitch elongation will limit the life of the chain, therefore, the following information will aid in determining when the chain requires replacement. During operation, chain pins and bushings slide against each other as the chains engages, wraps, and disengages from its sprockets. Even when the parts are well lubricated, some metal to metal contact does occur, and these parts will wear. This progressive joint wear elongates chain pitch, causing the chain to lengthen and ride higher on the sprocket teeth.

The number of teeth in the large sprocket determines the amount of joint wear tolerated before the chain jumps or rides over the ends of the sprocket teeth. When this critical elongation is reached, the chain must be replaced.

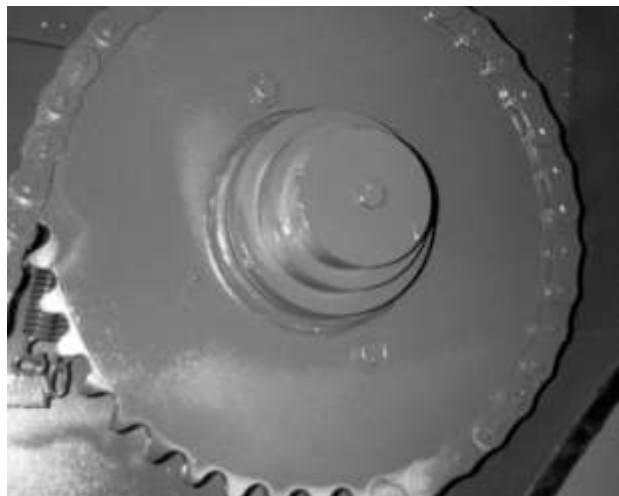
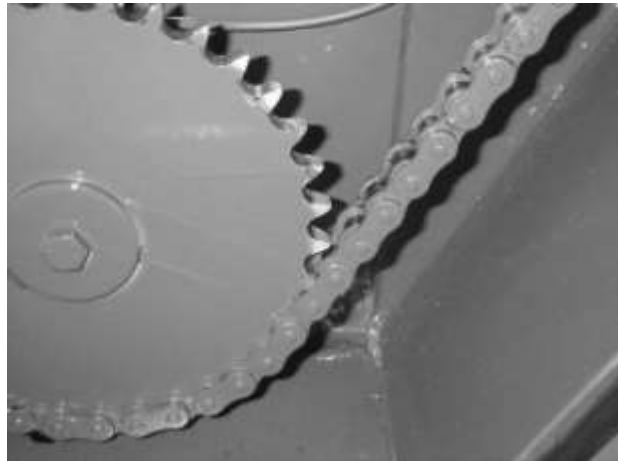

### Determination of Chain Wear

An evaluation of a chain's useful service life requires an analysis of pitch elongation. By placing a certain number of pitches under tension, elongation can be measured. When elongation equals or exceeds the limits in **Table 1**, the chain should be replaced.

- A. Remove chain from sprockets and lay on a smooth, horizontal surface or suspend vertically. To remove the slack from a chain in a horizontal position, refer to **Table 2** and apply the load indicated for that size of chain. If the chain must be measured while on the sprockets, remove the slack on a span of chain and apply sufficient tension to keep the chain taut.
- B. When the chain is properly tensioned, consult **Table 1** for the number of pitches that should be measured. The chain size and the number of teeth in the largest sprocket determine the number. Pitches should be measured from centre to centre of the pins. If the chain has offset links, do not include them in the measured segment.
- C. Select the appropriate column according to the number of teeth in the largest sprocket and compare the published figure with the measurement taken. If the measurement equals or exceeds the figure in **Table 1**, the chain should be replaced. If a chain breaks or fails due to broken pins, sidebars, or rollers, emergency temporary repairs may be done to avoid a long shut down. However, replacement of the entire chain is preferred for the following reasons:
  1. If one section of a chain has broken due to fatigue, other sections were subject to the same fatigue and are likely to fail.
  2. If the chain has been broken by a single high overload, parts other than those at the point of failure are usually bent or weakened.

Table 1

Chain Number ANSI	Pitch In Inches	Number of Pitches	Nominal Length	Number of Teeth in Largest Sprocket		
				0-67	68-73	74-81
				Maximum Elongation (Inches)		
60	0.75	16	12.0	12.38	12.34	12.31
80	1.00	24	24.0	24.75	24.69	24.63
100	1.25	20	25.0	25.75	25.69	25.63
120	1.50	16	24.0	24.75	24.69	24.63
140	1.75	14	24.5	25.25	24.19	25.13

Table 2

Chain Measuring Chart	
Chain Number	Applied Load In Pounds
60	70
80	125
100	195
120	289
140	386

## Installing New Chain

Before installing a new chain, carefully check the teeth on the sprocket. If the teeth are worn to a hooked shape, the sprockets should be replaced to ensure full performance and long life from the new chain. Proper tension is essential when installing new chain. Tight chain causes an additional load which increases wear on chain joints, sprockets and shaft bearings. Slack chain produces vibration that may result in excessive chain wear, noise, or shock loading.

## Sprocket Inspection

Check for these common sprocket problems which lead to replacement.

1. Wear on the sides are due to misalignment.
2. Tooth wear (indicated by hooking).
3. Broken teeth.
4. Cracks that might lead to failure.
5. Wobbling of sprockets on shaft.

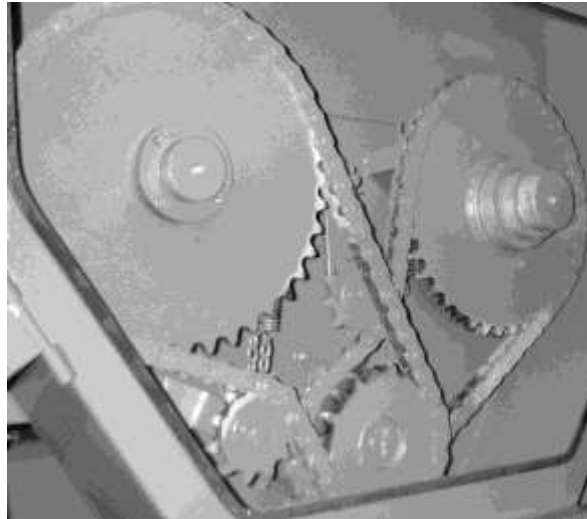

## Grease Bearings

For the best results, the grease should be pumped into the bearings slowly until a very slight bead of grease forms around the bearing seals on the shaft. This bead, in addition to acting as an indication of adequate lubrication, provides additional protection against the entry of foreign matter. To prevent premature bearing failure, always ensure that the grease nipple, grease gun end, and the grease itself, is clean and free of any dirt, grit, paint or foreign matter.

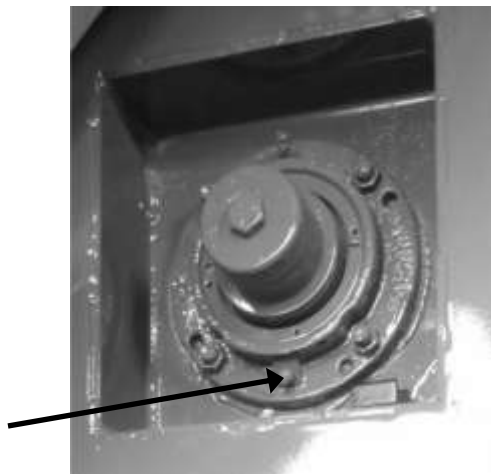

Front - each bearing individually

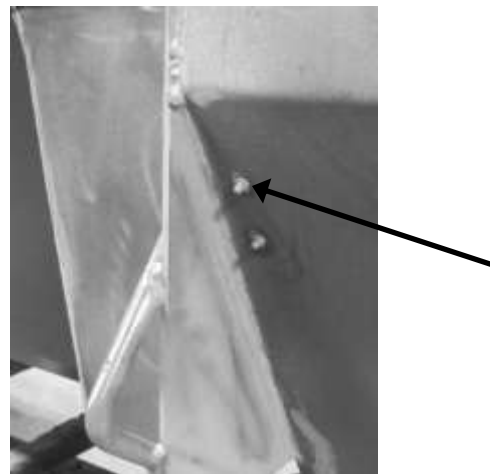

Rear - grease bank each side

### Planetary Gearbox

Use the sight glass on the side of the planetary gearbox to check the oil level in the gearbox.

To add oil, remove the plug opposite the sight glass and use a funnel or short piece of hose to add oil until it is visible in the sight glass.

To drain the oil, remove the drain plug(s) located on the bottom of the gearbox. Always replace the drain plug(s) and tighten immediately after the oil is drained. Refill per the above instructions with the correct oil found in the **Lubrication Spec's Chart**.

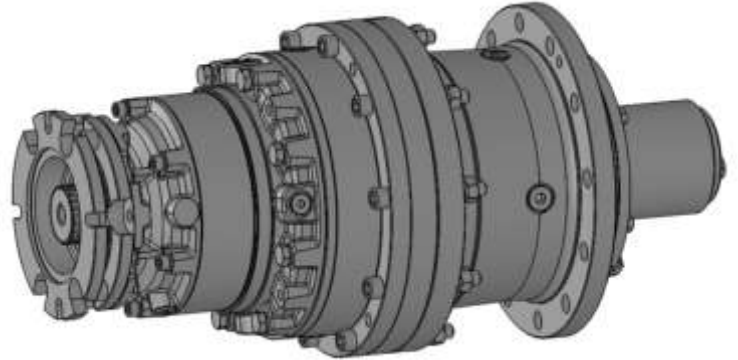

### Hydraulic Power Unit

Check the oil in the hydraulic unit using the sight glass on the front of the tank.

Add any oil necessary through the filler cap above the sight glass.



## Rear Drive Compartment

The Rear Drive Compartment or Oil Bath Compartment on horizontal models encloses the chain and sprockets used to drive the mixing augers. This dual purpose design keeps out dirt and other contamination as well as providing a sealed oil bath for the chains and sprockets.



Ensure that the oil drain plug is installed in the bottom of the oil sump and the enclosure is free of any contamination or obstruction. Fill the enclosure with oil to the centre of the chain on the lowest drive gear. To check the oil level, open the rear door when the unit is stopped.

## Door Adjustment

The rear oil bath (**horizontal**) door has a series of locking latches which provide the pressure to hold the seal tight between the door and the body of the oil bath. If the door seals becomes damaged or compressed so it will not seal, it should be replaced.



## 6. Maintenance Schedule

The following items are to be checked and, if necessary, corrective action taken. This schedule is designed for units operating under normal conditions. If the unit is operating in adverse or severe usage conditions it may be necessary for the items to be checked and serviced more frequently.

Check & Inspect the Following Every:	8 HRS	50 HRS	500 HRS
<b>Auger Drive System</b>			
Planetary oil level (sight glass on planetary) - check	*X		
Planetary - drain & refill			**X
Bearings - grease	X		
Chains & sprockets - check for wear & adjustment		X	
<b>Hydraulic System</b>			
Hydraulic Fluid - check level	X		
Leaks in System - check	X		
Roof hinges - grease		X	

\* When oil is warm

\*\* Drain & Refill after the first 100 Hours

**Mixer Information** *Please fill in the following:*

Model # \_\_\_\_\_ Serial # \_\_\_\_\_

Date Machine Put Into Service \_\_\_\_\_

Farm / Operation Name: \_\_\_\_\_

Dealer: \_\_\_\_\_

**Service Record\***

Hours	Date	Signature	Service Performed / Comments
100			
600			
1100			
1600			
2100			
2600			
3100			
3600			
4100			
4600			
5100			
5600			
6100			
6600			
7100			
7600			
8100			
8600			
9100			

*\* Note: hours given are for planetary oil changes and major services, all regular service must be completed as per service schedule.*



## 7. Lubrication Specifications

Main Auger Bearings ..... **NLGI #2 or #3 Lithium Base Grease**

Planetary Gearbox .....	<b>Mobil SHC 629</b> <b>Esso SHP 150</b> <b>Shell Morlina S4 B 150</b> <i>(synthetic oils listed)</i>	] *
-------------------------	--	-----

*Approximate Oil Capacity: 2.5 L (3/4 gallon)*

Drive Chain ..... **SAE-20 to SAE-30 Motor Oil**

Hydraulic Oil ..... **SAE-10 ISO 32 or Equivalent**  
**Indol #32**  
**Dextron #32**

*\* - Helm Welding recommends the use of synthetic oils in all planetary gearboxes. Gearboxes are filled with synthetic oils at time of manufacture.*

## Appendix - Mixer Requirements

**Electrical** - 220 volts single phase, 15 amps

**Mixer foundation** - solid and level concrete surface (minimum dimensions given below)

Model	Length	Width	Thickness
4120	8 feet	8 feet	6 inches
4185	12 feet	8 feet	6 inches
4260	14 feet	9 feet	6 inches
4360	18 feet	9 feet	6 inches

**Vertical Clearance** (from ground with roof open)

Models 4120/4185 - 16 feet

Models 4260/4360 - 17 feet