

Operator's Manual

MA900

Boom Mower





500 Venture Drive
Orrville Oh 44667
www.ventrac.com

View all manuals



Visit ventrac.com/manuals for the latest version of this operator's manual.

A downloadable parts manual is also available.

To the Owner Contact Information and Product Identification

If you need to contact an authorized Ventrac dealer for information on servicing your product, always provide the product model and serial numbers.

Please fill in the following information for future reference. See the picture(s) below to find the location of the identification numbers. Record them in the spaces provided.

Date of Purchase: _____

Dealer: _____

Dealer Address: _____

Dealer Phone Number: _____

Dealer Fax Number: _____

Model # (A): _____

Serial # (B): _____

Affix Part/Serial Number label here.



Venture Products Inc. reserves the right to make changes in design or specifications without obligation to make like changes on previously manufactured products.

TABLE OF CONTENTS

INTRODUCTION	PAGE 5
Product Description.....	5
Why Do I Need an Operator's Manual?	5
Using Your Manual.....	6
Manual Glossary	6
SAFETY	PAGE 7
Safety Decals.....	7
General Safety Procedures.....	9
Training Required.....	9
Requirements for Personal Protective Equipment (PPE).....	9
Operation Safety	9
Preventing Accidents.....	10
Keep Riders Off.....	10
Operating On Slopes.....	11
Roadway Safety	11
Truck Or Trailer Transport.....	11
Maintenance.....	12
Fuel Safety.....	12
Hydraulic Safety	13
OPERATIONAL CONTROLS	PAGE 15
Operational Control Locations.....	15
Primary SDLA Control Lever (A).....	15
Secondary SDLA Control Lever (B)	15
Main Arm/Cutter Bar Selector Switch (C).....	15
Float Switch - Active Function Only (D).....	15
Float Switch - Main Arm & Cutter Bar (E).....	15
Outer Arm Selector Switch (F)	15
GENERAL OPERATION	PAGE 16
Daily Inspection.....	16
Attaching	16
Detaching.....	16
Boom Mower Operating Procedures.....	17
Transport of Boom Mower.....	17
Cutter Bar Lockout Arm.....	18
Boom Mower Outer Arm Lockout.....	18
Boom Mower Storage Position.....	18
Boom Mower Trailer Transport and Storage Position	19
Clearing a Blockage	19
SERVICE	PAGE 20
Cleaning and General Maintenance.....	20
Belt Inspection.....	20
Belt Replacement.....	20
Checking Hydraulic Oil Level	20
Changing Hydraulic Oil	20

TABLE OF CONTENTS

SERVICE (Cont.)

Changing Hydraulic Oil Filter	21
Lubrication Locations	21
Cleaning and Lubricating Cutter Bar	22
Checking and Adjusting Upper Blade Guide Clearance.....	22
Blade Assembly Removal	23
Blade Assembly Replacement	23
Knife Blade Replacement.....	24
Blade Assembly Installation	24
Double Finger Guard Replacement	25
Pivot Chain Tension Inspection and Adjustment	25
Storage.....	26
Maintenance Schedule.....	27
Maintenance Checklist.....	28

SPECIFICATIONS

PAGE 29

Dimensions	29
Features	29

WARRANTY

PAGE 30

INTRODUCTION



Venture Products Inc. is pleased to provide you with your new Ventrac MA900 boom mower! We hope that Ventrac equipment will provide you with a ONE Tractor Solution.

Product Description

The Ventrac MA900 boom mower is designed for mowing and trimming hard to reach areas such as steep embankments, under fences and guardrails, across ditches, and around ponds and can also be used for trimming hedges or small tree branches along trails, driveways, or roads.

The boom mower features double action sickle bar with a 39 inch (99 cm) cutting width and a horizontal reach of 115" (2.9 m) from the outside of single wheels / 103" (2.6 m) from the outside of dual wheels. The boom mower features a vertical reach of 142 inches (3.6 m) from the ground. Maximum height for a cut parallel to the ground is 82 inches (2.1 m).

The cutter bar can be rotated from 90 degrees up to 45 degrees down (135 degrees total range) and features an innovative design that maintains the cutter bar angle when the boom arm is extended/retracted or raised/lowered. The boom mower also features float capabilities (optional auxiliary float spool required) for either the cutter bar angle, the boom arm height, or both simultaneously.

The cutter bar is equipped with breakaway features that allow the cutter bar to rotate to the rear if an object is struck and also to rotate upward in case of excessive ground contact. The cutter bar motor is equipped with a relief valve that relieves hydraulic flow to the motor if the knife blades become jammed.

The power unit must be equipped with both a 12 volt front (switch & plug) kit and a dual hydraulic auxiliary kit. Refer to your power unit operator's manual for the proper kits for your power unit.

In order to use the boom mower's float capabilities, the power unit must be equipped with a float spool on the secondary port of the SDLA hydraulic valve.

Why Do I Need an Operator's Manual?

This manual has been created to help you gain the important knowledge of what is needed to safely operate, maintain, and service your machine. It is divided into sections for convenient reference of the appropriate section.

You must read and understand the operator's manual for each piece of Ventrac equipment you own. Reading the operator's manual will help you become familiar with each specific piece of equipment. Understanding the operator's manual will help you, as well as others, avoid personal injury and/or damage to the equipment. Keep this manual with the machine at all times. The manual should remain with the machine even if it is sold. If this manual becomes damaged or unreadable, it should be replaced immediately. Contact your local Ventrac dealer for a replacement.

When using a Ventrac attachment, be sure to read and follow the safety and operating instructions of both the power unit and the attachment being used to ensure the safest operation possible.

The information in this manual provides the operator with the safest procedures to operate the machine while getting the maximum use out of the unit. Failure to follow the safety precautions listed in this manual may result in personal injury and/or damage to the equipment.

INTRODUCTION

Using Your Manual

Throughout this manual, you will encounter special messages and symbols that identify potential safety concerns to help you as well as others avoid personal injury or damage to the equipment.

SYMBOL DEFINITIONS



ATTENTION

This symbol identifies potential health and safety hazards. It marks safety precautions. Your safety and the safety of others is involved.

There are three signal words that describe the level of safety concern: Danger, Warning, and Caution. Safety should always be the #1 priority when working on or operating equipment. Accidents are more likely to occur when proper operating procedures are not followed or inexperienced operators are involved.

Note: Right-Hand and Left-Hand orientations may be referred to at different places throughout this manual. Right-Hand and Left-Hand is determined as if facing forward from the operator station.

SIGNAL WORD DEFINITIONS

⚠ DANGER

Indicates an imminently hazardous situation which, if not avoided, will result in death or serious injury. This signal word is limited to the most extreme cases.

⚠ WARNING

Indicates a potentially hazardous situation which, if not avoided, could result in death or serious injury.

⚠ CAUTION

Indicates a potentially hazardous situation which, if not avoided, may result in minor or moderate injury and/or property damage. It may also be used to alert against unsafe practices.

Manual Glossary

Power Unit A Ventrac tractor or other Ventrac engine powered device that may be operated by itself or with an attachment or accessory.

Attachment A piece of Ventrac equipment that requires a Power Unit for operation.

Accessory A device that attaches to a Power Unit or Attachment to extend its capabilities.

Machine Describes any "Attachment" or "Accessory" that is used in conjunction with a power unit.

SAFETY

Safety Decals

The following safety decals must be maintained on your MA900 boom mower.

Keep all safety decals legible. Remove all grease, dirt, and debris from safety decals and instructional labels. If any decals are faded, illegible, or missing, contact your dealer promptly for replacements.

When new components are installed, be sure that current safety decals are affixed to the replacement components.

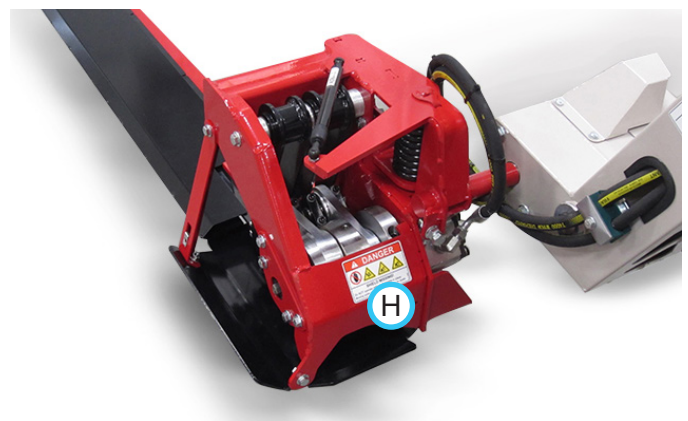
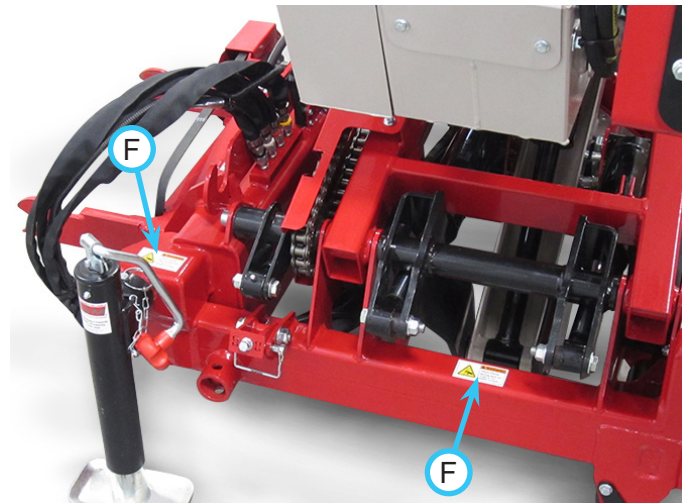
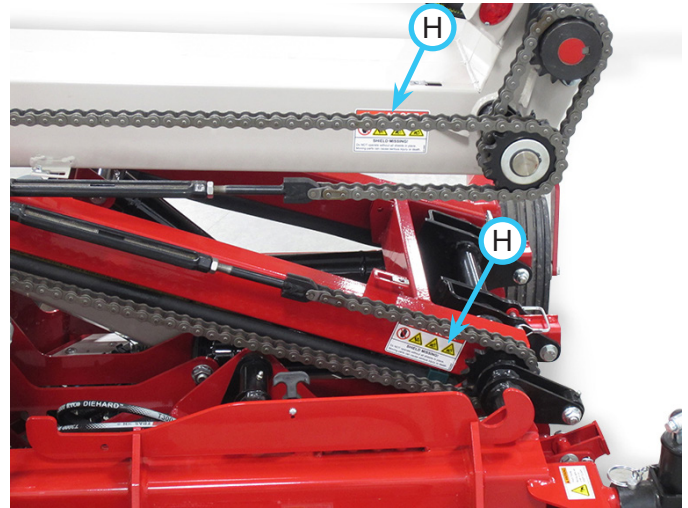
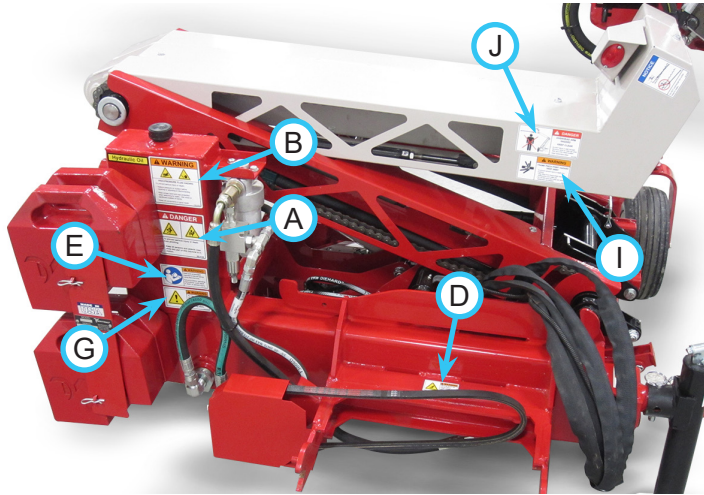

SAFETY

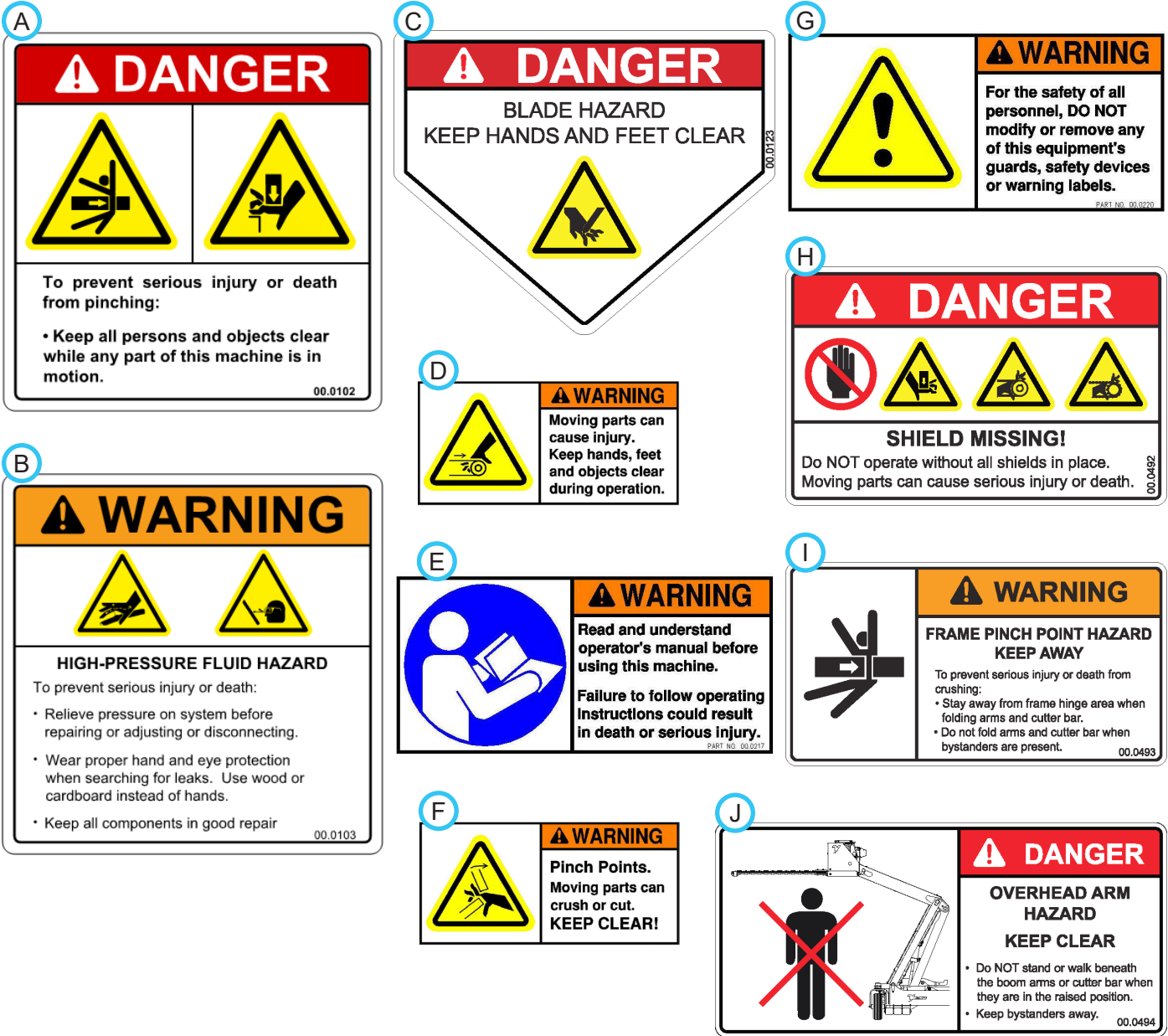

Decal	Description	Part Number	Quantity
A	Danger, Pinching Hazard	00.0102	1
B	Danger, High Pressure Fluid Hazard	00.0103	1
C	Danger, Keep Hands & Feet Clear	00.0123	1
D	Warning, Moving Parts	00.0216	1
E	Warning, Read Owner's Manual	00.0217	1
F	Warning, Pinch Point	00.0218	2
G	Warning, General Safety	00.0220	1
H	Danger, Shield Missing	00.0492	3
I	Warning, Frame Pinch Point	00.0493	2
J	Danger, Keep Clear	00.0494	2

SAFETY



General Safety Procedures for Ventrac Power Units, Attachments, & Accessories



Training Required

- The owner of this machine is solely responsible for properly training the operators.
- The owner/operator is solely responsible for the operation of this machine and prevention of accidents or injuries occurring to him/herself, other people, or property.
- Do not allow operation or service by children or untrained personnel. Local regulations may restrict the age of the operator.
- Before operating this machine, read the operator's manual and understand its contents.
- If the operator of the machine cannot understand this manual, then it is the responsibility of this machine's owner to fully explain the material within this manual to the operator.
- Learn and understand the use of all controls.
- Know how to stop the power unit and all attachments quickly in the event of an emergency.



Requirements for Personal Protective Equipment (PPE)

The owner is responsible for ensuring that all operators use the proper PPE while operating the machine. Whenever you use the machine, use the following PPE:



- Certified eye protection and hearing protection.
- Closed toe, slip resistant footwear.
- Long pants.
- A dust mask for dusty conditions.

Operation Safety

- Inspect machine before operation. Repair or replace any damaged, worn, or missing parts. Be sure guards and shields are in proper working condition and are secured in place. Make all necessary adjustments before operating machine.
- Some pictures in this manual may show shields or covers opened or removed in order to clearly illustrate any instructions. Under no circumstance should the machine be operated without these devices in place.
- Alterations or modifications to this machine can reduce safety and could cause damage to the machine. Do not alter safety devices or operate with shields or covers removed.
- Before each use, verify that all controls function properly and inspect all safety devices. Do not operate if controls or safety devices are not in proper working condition.
- Check parking brake function before operating. Repair or adjust parking brake if necessary.
- Observe and follow all safety decals.
- All controls are to be operated from the operator's station only.
- Always wear a seat belt if the machine has a roll cage/bar installed and in upright position.
- Ensure the attachment or accessory is locked or fastened securely to the power unit before operating.
- Ensure that all bystanders are clear of the power unit and attachment before operating. Stop machine if someone enters your work area.
- Always be alert to what is happening around you, but do not lose focus on the task you are performing. Always look in the direction the machine is moving.
- Look behind and down before backing up to be sure of a clear path.
- If you hit an object, stop and inspect the machine. Make all necessary repairs before operating machine again.
- Stop operation immediately at any sign of equipment failure. An unusual noise can be a warning of equipment failure or a sign that maintenance is required. Make all necessary repairs before operating machine again.
- If equipped with a high/low range feature, never shift between high and low range while on a slope. Always move the machine to level ground and engage the parking brake before shifting range.

SAFETY



General Safety Procedures for Ventrac Power Units, Attachments, & Accessories



Operation Safety (continued)

- Do not leave machine unattended while it is running.
- Always park the machine on level ground.
- Always shut off engine when connecting attachment drive belt to the power unit.
- Never leave the operator's station without lowering the attachment to the ground, setting the parking brake, shutting off the engine, and removing the ignition key. Make sure all moving parts have come to a complete stop before dismounting.
- Never leave equipment unattended without lowering the attachment to the ground, setting the parking brake, shutting off the engine, and removing the ignition key.
- Only operate in well-lit conditions.
- Do not operate when there is a risk of lightning.
- Never direct the discharge of any attachment in the direction of people, buildings, animals, vehicles, or other objects of value.
- Never discharge material against a wall or obstruction. Material may ricochet back towards the operator.
- Use extra caution when approaching blind corners, shrubs, trees, or other objects that may obscure vision.
- Do not run the engine in a building without adequate ventilation.
- Do not touch the engine or the muffler while the engine is running or immediately after stopping the engine. These areas may be hot enough to cause a burn.
- Do not change the engine governor settings or over-speed the engine. Operating engine at excessive speed may increase the hazard of personal injury.
- To reduce the hazard of fire, keep the battery compartment, engine, and muffler areas free of grass, leaves, excessive grease, and other flammable materials.
- Secure long hair and loose clothing. Do not wear jewelry.

Preventing Accidents



- Clear working area of objects that might be hit or thrown from machine.
- Keep people and pets out of working area.
- Know the work area well before operation. Do not operate where traction or stability is questionable.
- Reduce speed when you are operating over rough ground.
- Equipment can cause serious injury and/or death when improperly used. Before operating, know and understand the operation and safety of the power unit and the attachment being used.

- Do not operate machine if you are not in good physical and mental health, if you will be distracted by personal devices, or are under the influence of any substance which might impair decision, dexterity, or judgment.
- Children are attracted to machine activity. Be aware of children and do not allow them in the working area. Turn off the machine if a child enters the work area.

Keep Riders Off

- Only allow the operator on the power unit. Keep riders off.
- Never allow riders on any attachment or accessory.

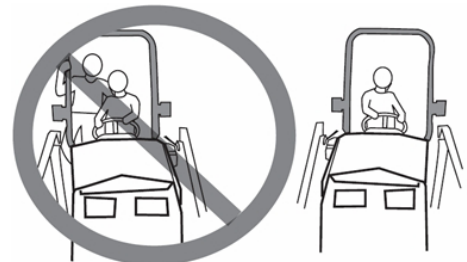

SAFETY



General Safety Procedures for Ventrac Power Units, Attachments, & Accessories



Operating On Slopes

- Slopes can cause loss-of-control and tip-over accidents, which can result in severe injury or death. Be familiar with the emergency parking brake, along with the power unit controls and their functions.
- If power unit is equipped with a fold down roll bar, it must be locked in the upright position when operating on any slope.
- Use low range (if equipped) when operating on slopes greater than 15 degrees.
- Do not stop or start suddenly when operating on slopes.
- Never shift between high and low range while on a slope. Always move the power unit to level ground and engage the parking brake before shifting range or placing the power unit in neutral.
- Variables such as wet surface and loose ground will reduce the degree of safety. Do not drive where machine could lose traction or tip over.
- Keep alert for hidden hazards in the terrain.
- Stay away from drop-offs, ditches, and embankments.
- Sharp turns should be avoided when operating on slopes.
- Pulling loads on hills decreases safety. It is the responsibility of the owner/operator to determine loads that can safely be controlled on slopes.
- Transport machine with attachment lowered or close to the ground to improve stability.
- While operating on slopes, drive in an up and down direction when possible. If turning is necessary while driving across slopes, reduce speed and turn slowly in the downhill direction.
- Ensure a sufficient supply of fuel for continuous operation. A minimum of one-half tank of fuel is recommended.

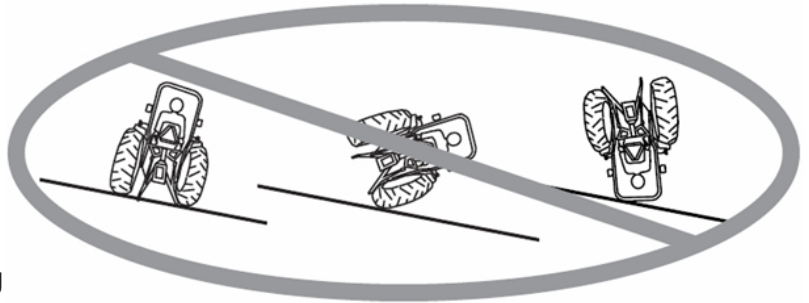

Roadway Safety

- Operate with safety lights when operating on or near roadways.
- Obey all state and local laws concerning operation on roadways.
- Slow down and be careful of traffic when operating near or crossing roadways. Stop before crossing roads or sidewalks. Use care when approaching areas or objects that may obscure vision.
- If there is doubt of safety conditions, discontinue machine operation until a time when operation can be performed safely.
- When operating near or on roadways, have a Slow Moving Vehicle Emblem clearly displayed.

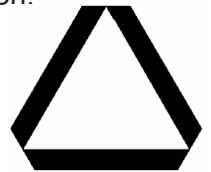

Truck Or Trailer Transport

- Use care when loading or unloading machine into a truck or trailer.
- Use full width ramps for loading machine into a truck or trailer.
- The parking brake is not sufficient to lock the machine during transport. Always secure the power unit and/or attachment to the transporting vehicle securely using straps, chains, cable, or ropes. Both front and rear straps should be directed down and outward from the machine.
- Shut off fuel supply to power unit during transport on truck or trailer.
- If equipped, turn the battery disconnect switch to the Off position to shut off electrical power.

SAFETY



General Safety Procedures for Ventrac Power Units, Attachments, & Accessories



Maintenance

- Keep all safety decals legible. Remove all grease, dirt, and debris from safety decals and instructional labels.
- If any decals are faded, illegible, or missing, contact your dealer promptly for replacements.
- When new components are installed, be sure that current safety decals are affixed to the replacement components.
- If any component requires replacement, use only original Ventrac replacement parts.
- Always turn the battery disconnect to the Off position or disconnect the battery before performing any repairs. Disconnect the negative terminal first and the positive terminal last. Reconnect the positive terminal first and the negative terminal last.
- Keep all bolts, nuts, screws, and other fasteners properly tightened.
- Always lower the attachment to the ground, engage parking brake, shut off engine, and remove the ignition key. Make sure all moving parts have come to a complete stop before cleaning, inspection, adjusting or repairing.
- If the power unit, attachment, or accessory requires repairs or adjustments not instructed in the operator's manual, the power unit, attachment, or accessory must be taken to an authorized Ventrac dealer for service.
- Never perform maintenance on the power unit and/or attachment if someone is in the operator's station.
- Always use protective glasses when handling the battery.
- Check all fuel lines for tightness and wear on a regular basis. Tighten or repair them as needed.
- To reduce the hazard of fire, keep the battery compartment, engine, and muffler areas free of grass, leaves, and excessive grease.
- Do not touch the engine, the muffler, or other exhaust components while the engine is running or immediately after stopping the engine. These areas may be hot enough to cause a burn.
- Allow the engine to cool before storing and do not store near an open flame.
- Do not change the engine governor settings or over-speed the engine. Operating engine at excessive speed may increase the hazard of personal injury.
- Springs may contain stored energy. Use caution when disengaging or removing springs and/or spring loaded components.
- An obstruction or blockage in a drive system or moving/rotating parts may cause a buildup of stored energy. When the obstruction or blockage is removed, the drive system or moving/rotating parts may move suddenly. Do not attempt to remove an obstruction or blockage with your hands. Keep hands, feet, and clothing away from all power-driven parts.

Fuel Safety



- To avoid personal injury or property damage, use extreme care in handling gasoline. Gasoline is extremely flammable and the vapors are explosive.
- Do not refuel machine while smoking or at a location near flames or sparks.
- Always refuel the machine outdoors.
- Do not store machine or fuel container indoors where fumes or fuel can reach an open flame, spark, or pilot light.
- Only store fuel in an approved container. Keep out of reach of children.
- Never fill containers inside a vehicle or on a truck or trailer bed with a plastic liner. Always place containers on the ground away from your vehicle before filling.
- Remove machine from the truck or trailer and refuel it on the ground. If this is not possible, refuel the machine using a portable container, rather than from a fuel dispenser nozzle.
- Never remove fuel cap or add fuel with the engine running. Allow engine to cool before refueling.
- Never remove fuel cap while on a slope. Only remove when parked on a level surface.
- Replace all fuel tank and container caps securely.
- Do not overfill fuel tank. Only fill to bottom of fuel neck, do not fill fuel neck full. Overfilling of fuel tank could

SAFETY



General Safety Procedures for Ventrac Power Units, Attachments, & Accessories



Fuel Safety (continued)

- result in engine flooding, fuel leakage from the tank, and/or damage to the emissions control system.
- If fuel is spilled, do not attempt to start the engine. Move the power unit away from the fuel spill and avoid creating any source of ignition until fuel vapors have dissipated.
- If the fuel tank must be drained, it should be drained outdoors into an approved container.
- Check all fuel lines for tightness and wear on a regular basis. Tighten or repair them as needed.
- The fuel system is equipped with a shut-off valve. Shut off the fuel when transporting the machine to and from the job, when parking the machine indoors, or when servicing the fuel system.

Hydraulic Safety

- Make sure all hydraulic connections are tight and all hydraulic hoses and tubes are in good condition. Repair any leaks and replace any damaged or deteriorated hoses or tubes before starting the machine.
- Hydraulic leaks can occur under high pressure. Hydraulic leaks require special care and attention.
- Use a piece of cardboard and a magnifying glass to locate suspected hydraulic leaks.



- Keep body and hands away from pinhole leaks or nozzles that eject high pressure hydraulic fluid. Hydraulic fluid escaping under high pressure can penetrate the skin causing serious injury, leading to severe complications and/or secondary infections if left untreated. If hydraulic fluid is injected into the skin, seek immediate medical attention no matter how minor the injury appears.

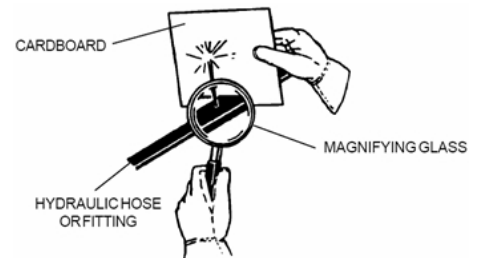

- Hydraulic system may contain stored energy. Before performing maintenance or repairs on the hydraulic system, remove attachments, engage parking brake, disengage weight transfer system (if equipped), shut off engine, and remove ignition key. To relieve pressure on the auxiliary hydraulic system, shut off the power unit engine and move the hydraulic control lever left and right before disconnecting the auxiliary hydraulic quick couplers.

SAFETY



MA900 Safety Procedures



- Contact with the knife blades or other moving parts may result in personal injury. Keep hands and feet away.
- Movement of the blade bar or finger guard bar may cause unintended movement of other parts. Keep hands and fingers away from moving parts.
- Wear heavy gloves when removing, installing, or adjusting the knife blades and/or cutter arm.
- Never perform adjustments or maintenance to the cutter arm with the engine running.
- When removing a blockage from the cutter bar, pressure or tension in the drive system may cause movement of the knife blades or finger guards. Never use your hands or feet to remove a blockage.
- The boom mower must be equipped with counterweights during operation. Install four Ventrac weights on the boom mower weight bars.
- When not mowing, always shut off the PTO to stop the cutter bar.
- Install the blade cover onto the cutter arm whenever the mower is not in use.
- Ensure that there are no objects or persons in the area of the mower arms or cutter bar before folding or adjusting the position of the mower arms or cutter bar.
- Use caution when operating around objects that can obstruct your vision.
- Do not attempt to cut material larger than the rated capacity of 1/2 inch (12.7 mm) diameter.
- Do not contact overhead objects with the raised mower arms or cutter bar.
- Do not contact overhead electric lines with the mower arms or cutter bar. Contact with electric lines could cause serious injury or death. To avoid serious injury or death from electrical contact, keep raised arms or cutter bar at least 10 feet (3 meters) from any electric lines.
- Inspect work area for obstacles that may be hidden by tall grass or brush. Check for wires or cables that could become entangled in the cutter bar. Mark any obstacles that cannot be removed.
- If trimming trees or hedges along driveways or roadways, ensure there are no overhead lines in the work area.
- Maximum degree of operation is 10° if the power unit is equipped with single wheels or 18° if the power unit is equipped with dual wheels.
- During transport, move the mower arms and cutter bar to the applicable transport position to reduce shock to the boom mower and power unit. Refer to the operation section of this manual for instructions.
- When parking the boom mower, the mower arms and cutter bar must be placed in one of the storage positions. Refer to the operation section of this manual for instructions.
- If performing service on the boom mower with the mower arms extended, the mower arms and cutter bar must be securely supported with blocks or jack stands to prevent movement of the mower arms or cutter bar.
- Attachment hydraulic system may contain stored energy. Before performing maintenance or repairs on the hydraulic system, the attachment's auxiliary hydraulic hoses must be disconnected from the power unit. Lower the attachment to the ground, move the boom mower arms and cutter bar to the storage position, shut off power unit engine, turn the ignition key to the run position, move the secondary SDLA lever left and right to relieve auxiliary hydraulic pressure (both with and without the switch pressed), and disconnect the auxiliary hydraulic quick couplers.



OPERATIONAL CONTROLS

Operational Control Locations

Use the following images to help identify the locations of operational controls. The letter next to each control can be referenced to the list that follows these images.

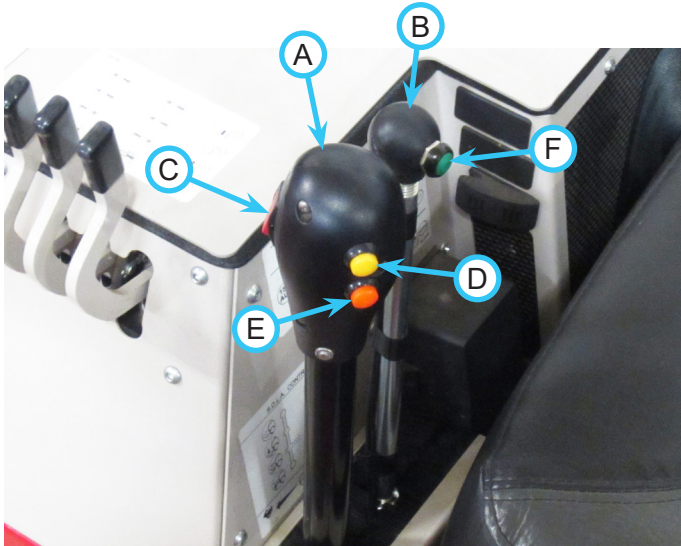

- A. Primary SDLA Control Lever
- B. Secondary SDLA Control Lever
- C. Main Arm/Cutter Bar Selector Switch
- D. Float Switch - Active Function Only
- E. Float Switch - Main Arm & Cutter Bar
- F. Outer Arm Selector Switch

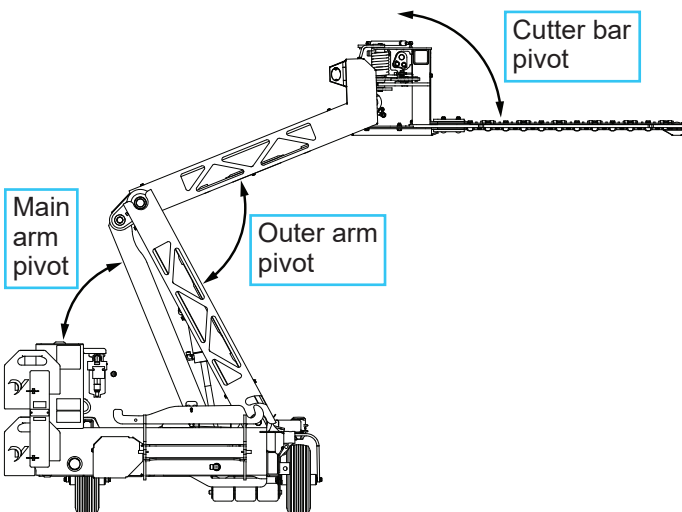

Primary SDLA Control Lever (A)

Pull the power unit's primary SDLA control lever to the left to raise the power unit front hitch and boom mower main frame. Push the control lever to the right to lower the power unit front hitch and boom mower main frame. The control lever must be in the float (detent) position during operation and transport of the boom mower.

Secondary SDLA Control Lever (B)

The power unit's secondary SDLA control lever controls boom mower functions through the auxiliary hydraulic quick couplers and depends on various inputs to determine the function being controlled. Moving the control lever to the left or right controls either the main arm pivot or the cutter bar pivot depending on the function selected using the main arm/cutter bar selector switch (C). Pressing the outer arm selector switch (F) while moving the lever left or right controls the outer arm pivot.

Main Arm/Cutter Bar Selector Switch (C)

The main arm/cutter bar selector switch is used to select the axis controlled by the secondary SDLA control lever. The boom mower is equipped with an indicator light (G) to show which function is selected. When the light is off, the main arm pivot function is selected. When the light is on, the cutter bar pivot function is selected.

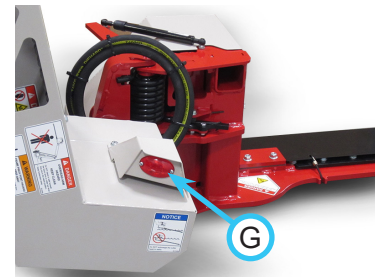

Float Switch - Active Function Only (D)

Pressing and holding the yellow float switch[^] allows the pivot that is currently selected by the main arm/cutter bar switch to float and follow the ground contour.

Float Switch - Main Arm & Cutter Bar (E)

Pressing and holding the orange float switch[^] allows both the main arm and cutter bar pivots to float simultaneously and follow the ground contour.

Outer Arm Selector Switch (F)

Pressing and holding the outer arm selector switch selects the outer arm pivot as the pivot controlled by the secondary SDLA control lever.

[^] The power unit must be equipped with a float spool on the secondary port of the SDLA hydraulic valve and the secondary control lever must be in the float (detent) position in order for the boom mower float switches to function.

GENERAL OPERATION

Daily Inspection

⚠ WARNING

Always set the parking brake, shut off power unit engine, remove the ignition key, and ensure all moving parts have come to a complete stop before inspecting components, or attempting any repair or adjustment.

1. Park machine on a level surface, with the engine shut off and all fluids cold.
2. Perform a visual inspection of both the power unit and the boom mower. Look for loose or missing hardware, damaged components, or signs of wear.
3. Inspect hydraulic hoses, hydraulic fittings, and fuel lines to ensure tight, leak free connections.
4. Inspect drive belt condition. Service as required.
5. Inspect cutter bar, knife blades, and blade guards for damage or wear. Service as required.
6. Check hydraulic oil level.
7. Refer to the power unit operator's manual. Check the power unit's engine oil, hydraulic oil, cooling system, tire pressure, and fuel level. Add fluid or service as required.
8. Test the power unit's operator safety interlock system*.

Attaching

1. Set the power unit's weight transfer system to high (maximum weight transfer).
2. Drive the power unit slowly forward into the hitch arms of the boom mower. Align the lift arms of the power unit with the boom mower hitch arms by raising or lowering the front hitch and complete the engagement.
3. Once completely engaged, close the front hitch locking lever.*
4. Engage the parking brake* and shut off the engine.
5. Raise the two jacks and move to the operating positions. Secure with the ball pins.

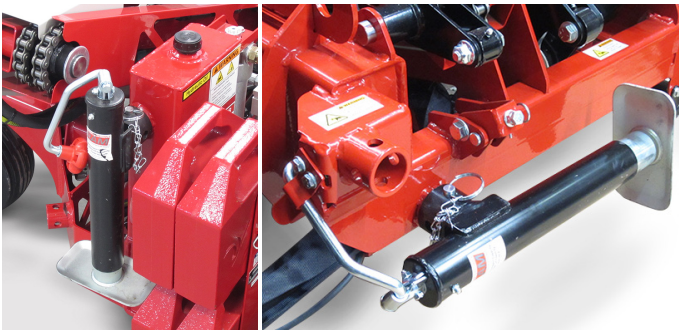

6. Secure the right jack handle with the jack handle latch.
7. Place the attachment belt onto the PTO drive pulley on the power unit. Ensure the belt is properly seated in each pulley.
8. Engage the PTO tension spring.
9. Wipe hose ends clean, and connect to the power unit's hydraulic quick couplers. Connect the hoses and quick couplers with the colored indicators paired together.
10. Connect electric plug to the power unit.
11. Disengage any mower arm and cutter bar lock-out devices.

Detaching

1. Park the power unit on a level surface and set the parking brake.*
2. Install the cutting edge cover onto the cutter bar and secure with the bungee cords.



3. Lower the boom mower to the ground and fold in the boom mower arms and the cutter bar as instructed in the section "Boom Mower Storage Position".
4. Shut off power unit engine.
5. Move the jacks to the storage positions and secure with the ball pins. Lower the jacks to support the boom mower.

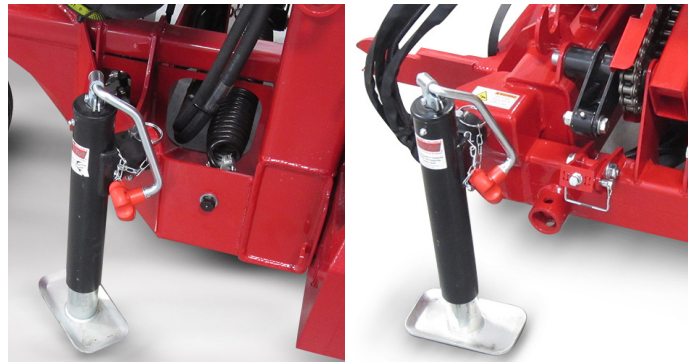

6. Disengage the PTO tension spring.
7. Remove the attachment belt from the PTO drive

* Refer to power unit operator's manual for operation of power unit controls.

GENERAL OPERATION

pulley of the power unit.

8. Disconnect the hydraulic quick couplers from the power unit and store the hose ends in the storage holes on the mower frame.

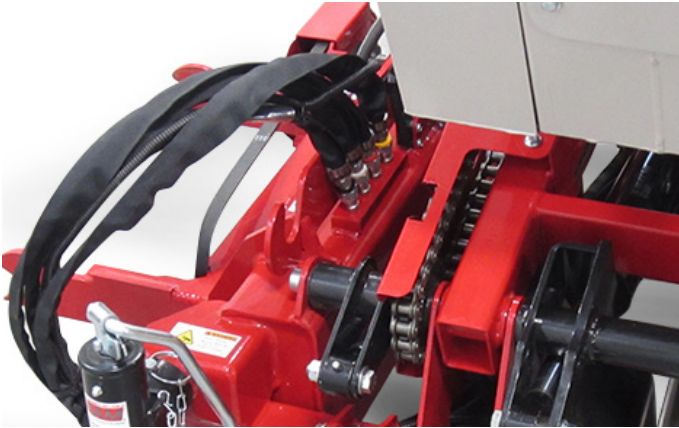

9. Disconnect the electric plug from the power unit.
10. Disengage the front hitch locking lever.*
11. Restart power unit and slowly back away from the boom mower. A side to side movement of the steering wheel may aid in disengagement.

Boom Mower Operating Procedures

⚠ DANGER

Prior to operation, check to ensure that four Ventrac weights are installed on the boom mower weight bars.

Before operation, perform daily inspection and confirm the power unit's weight transfer system is set to high (maximum weight transfer).

⚠ CAUTION

Knife blades and guards are sharp. Always wear heavy gloves when working with blades and guards.

Remove the cutting edge cover from the cutter bar. Lower the boom mower frame to the ground and place the power unit's primary SDLA lever in the float position by pushing it to the right until the detent engages. The lever will stay in this position until intentionally removed.

Align the power unit and boom mower with the work area and move the boom mower arms and cutter bar into the desired position. With the power unit engine running at approximately 2,000 RPM, engage the PTO switch then adjust the throttle to the desired engine RPM.

Drive forward slowly along the mowing path, moving the mower arms and cutter bar as necessary to

avoid obstacles.

Using the float controls will allow the cutter bar to follow the ground contours without having to manually adjust the cutting height and/or cutting angle. Pressing and holding the yellow switch will float the currently selected function. If the cutter bar function is selected, the cutter bar will follow the angle of the ground. If the main arm function is selected, the cutter bar height will raise or lower to follow the ground contours. Pressing and holding the orange switch will float both functions simultaneously.

The cutter head frame is designed with a spring loaded pivot that allows the cutter bar and head to rotate backward if contact is made with an obstacle. If contact with an obstacle causes the cutter head to breakaway, stop the power unit immediately. Shut off the PTO and back the power unit and boom mower slowly away from the obstacle until the cutter bar returns to the operating position. Do NOT raise or lower the mower arms or cutter bar while engaged with an obstacle. Anytime contact is made with an obstacle that causes the cutter head to breakaway, stop the machine and inspect the cutter bar for damage before proceeding.

If using the boom mower to trim overhead branches, extend the cutter bar away from the boom mower and reduce travel speed to prevent debris from falling on the machine or operator. Whenever possible, approach the material to be cut from an angle that allows debris to fall away from the machine.

Transport of Boom Mower

Always disengage the power unit PTO before transporting the boom mower.

Always fold in the boom mower arms and cutter bar before transporting the boom mower.



Attention

Transport the boom mower with the power unit's primary SDLA lever in the float position.

Travel slowly when transporting over undulating or rough surfaces to maintain control of the power unit and to reduce the shock to the power unit and boom mower.

When transporting the boom mower on a trailer, fold the boom mower arms and the cutter bar as instructed in the section "Boom Mower Trailer Transport and Storage Positions". Always engage applicable mower arm or cutter bar lock out devices when transporting the boom mower on a trailer.

GENERAL OPERATION

Cutter Bar Lockout Arm

When the cutter bar is rotated fully counterclockwise, the cutter bar lockout arm (A) can be engaged to prevent the cutter bar from rotating down due to hydraulic failure.

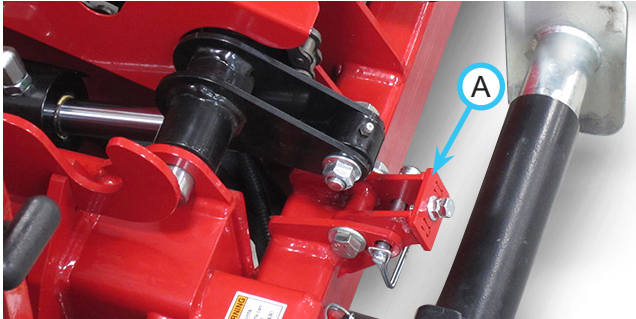

1. Remove the pin from the lockout arm.
2. Rotate the lockout arm up under the cylinder end.
3. Reinstall the pin to secure the lockout arm.

Boom Mower Outer Arm Lockout

When the outer arm of the boom mower is folded in, the lockout link can be used to prevent the outer arm from unfolding.

1. Remove lockout link (A) from the storage position.

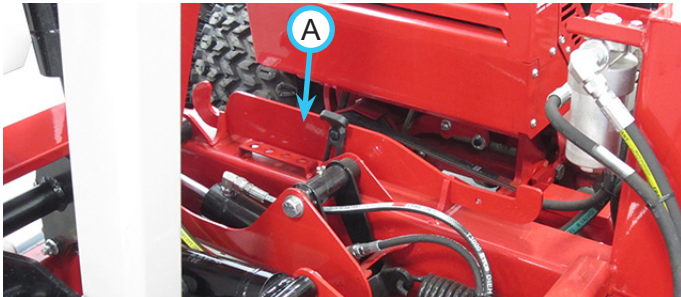

2. Place the hook end over the cutter head shaft.
3. Remove the ball pin from the lockout tabs on the main arm cross tube and place the lockout link between the two tabs.

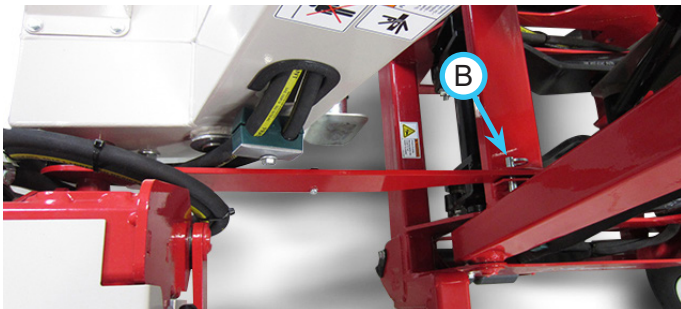

4. Unfold the outer arm slowly until the tab on the lockout link hooks on the cross tube.
5. Reinstall the ball pin (B) to secure the lockout link.

After removing the lockout link, return to the storage position and secure with the rubber latch handle.

Boom Mower Storage Position

Use the following position when storing the boom mower between uses or for seasonal storage.

1. Install the cutting edge cover onto the cutter bar.
2. Fold in the outer arm completely.
3. Fold the main arm down against the main frame bumper.
4. Rotate the cutter bar counterclockwise completely and engage the cutter bar lockout arm.



GENERAL OPERATION

Boom Mower Trailer Transport and Storage Position

Use the following position when transporting the boom mower and power unit on a trailer.

1. Install the cutting edge cover onto the cutter bar.
2. Rotate the main arm up into a vertical position.
3. Install the outer arm lockout link to secure the outer arm.
4. Rotate the cutter bar counterclockwise completely and engage the cutter bar lockout arm.
5. Rotate the main arm clockwise until the cutter head assembly is resting on the trailer.



This position can also be used for storage.

Clearing a Blockage

If the knife blades become jammed on brush or a sapling that is too thick to cut:

1. Shut off the power unit PTO.
2. Back slowly away until the blade releases from the object.
3. Inspect the knife blades and guards for damage before proceeding.

If the knife blades become jammed with grass or other material between the guards and the knife blades:

1. Shut off the power unit PTO, engage the parking brake, shut off the power unit engine, and remove the key from the ignition switch.
2. Remove the plastic plug (A) from the cutter drive cover.

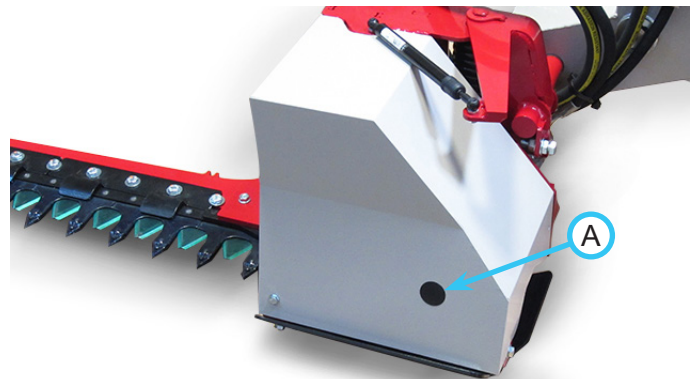

3. Place a 5/8" socket and a ratchet or breaker bar on the hex end of the crankshaft end plate, and turn the crankshaft clockwise to reverse the drive and discharge the material.
4. Reinstall the plastic plug in the cutter drive cover.

SERVICE

⚠ WARNING

Always set the parking brake, shut off power unit engine, remove the ignition key, and ensure all moving parts have come to a complete stop before inspecting components or attempting any repair or adjustment.



Attention

If any component requires replacement, use only original Ventrac replacement parts.

Cleaning and General Maintenance

For best results, and to maintain the finish of the boom mower, clean or wash the boom mower to remove accumulated clippings, leaves, brush, and dirt when the job is finished.

Clean and oil the cutter bar according to the instructions in the section “Cleaning and Lubricating Cutter Bar”.

Belt Inspection

Inspecting the boom mower’s attachment drive belt can prevent sudden belt failure by finding problems before they cause a belt to break.

Typical wear on a drive belt may result in the conditions shown in the diagram. If any of these conditions

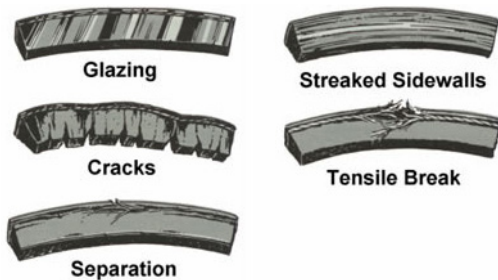

occur, the drive belt will require replacement.

Belt Replacement

1. Detach the boom mower from the power unit.
2. Remove the drive pulley shield (A).
3. Remove the old drive belt and install the new drive belt onto the pulley.
4. Reinstall the drive pulley shield.

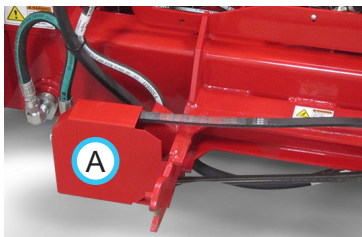

Checking Hydraulic Oil Level

Check the hydraulic oil level before operating unit, when the hydraulic system is cold. If the hydraulic system is warm, allow 1 hour for the hydraulic system to cool before checking. If the hydraulic oil is warm when the oil level is checked, it will produce an inaccurate oil level reading.

1. Park the power unit and boom mower on a level surface and fold in the boom mower arms.
2. Engage the parking brake, shut off the engine, and remove the key from the ignition switch. If necessary, allow time for the hydraulic system to cool.
3. Remove the dipstick (A) from the hydraulic oil tank and wipe with a clean cloth.
4. Set the dipstick back into place without threading in.
5. Remove the dipstick and check the oil level. The level should be between the two indicator lines on the dipstick.
6. If the hydraulic oil level is low, add Ventrac Hydro-Torq XL synthetic hydraulic oil until the proper level is reached.
7. Reinstall the dipstick into the hydraulic oil tank.

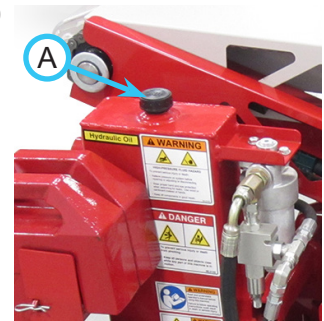

Changing Hydraulic Oil

1. Park the power unit and boom mower on a level surface and fold in the boom mower arms.
2. Engage the parking brake, shut off the engine, and remove the key from the ignition switch.
3. Place a drain pan of sufficient size under the drain plug on the bottom of the oil tank. NOTE: the boom mower holds approximately 5-1/2 gallons (20.8 liters) of hydraulic oil.
4. Remove the drain plug to drain the oil.
5. After draining the oil, reinstall the drain plug into the oil tank.
6. Remove the dipstick from the oil tank and add Ventrac Hydro-Torq XL synthetic hydraulic oil until the proper level is reached.
7. Clean up any spilled oil and dispose of oil in accordance with local laws.

⚠ CAUTION

Oil is hazardous to the environment. Drain oil into an approved container and dispose of used oil in accordance with local laws.

SERVICE

Changing Hydraulic Oil Filter

1. Park the power unit and boom mower on a level surface and fold in the boom mower arms.
2. Engage the parking brake, shut off the engine, and remove the key from the ignition switch.
3. Place a drain pan beneath the filter area to catch any oil leakage.
4. Remove the oil filter bowl (A) from the filter assembly and unscrew the filter element from the filter head.
5. Screw the new filter element onto the filter head.
6. Reinstall the oil filter bowl onto the filter assembly and torque to 45 ft-lbs (61 Nm).
7. Clean up any spilled oil and dispose of oil and filter in accordance with local laws.

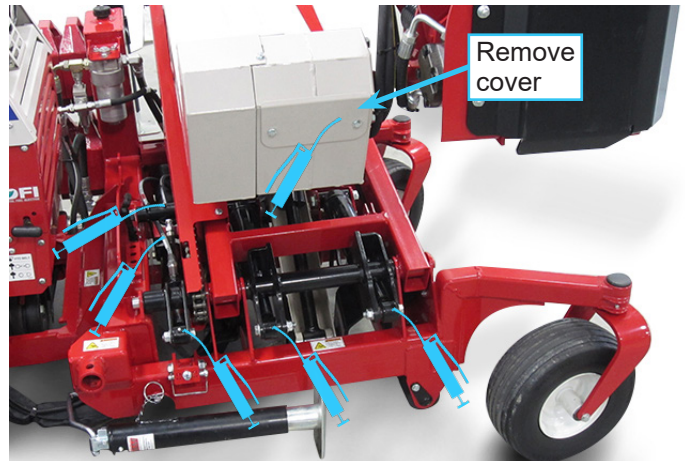
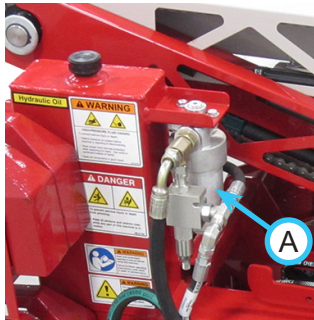

Rotate the main arm up and extend the outer arm away from the main arm to provide clearance for removing the chain guards. After removing the chain guards, lower the cutter head until it is resting on the ground. Apply grease to the following grease points and apply chain oil to the pivot control chains.



⚠ CAUTION

Oil is hazardous to the environment. Drain oil into an approved container and dispose of used oil in accordance with local laws.

Lubrication Locations

Lubrication is required at the following locations using a lithium complex NLGI #2 grease. Refer to the maintenance schedule for service intervals and amount of grease.

Place the boom mower arms and cutter bar in the storage position and apply grease to the following locations.

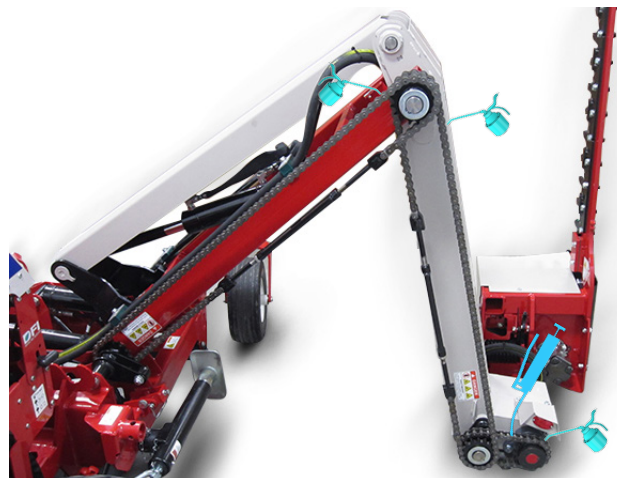

Clean up any excess grease or oil. Inspect chain tension prior to reinstalling the chain guards.

SERVICE

Cleaning and Lubricating Cutter Bar

1. Fold in the boom mower arms and rotate the cutter bar down to an accessible position.
2. Park the power unit and boom mower on a level surface.
3. Engage the parking brake, shut off the engine, and remove the key from the ignition switch.
4. Wash the cutter bar with a pressure washer.
5. Run the cutter bar for a few seconds to shed excess water.
6. When the cutter bar is dry, lubricate thoroughly with an environmentally friendly viscous oil. Ventrac recommended oil is UltraLube Chain and Cable Oil (Ventrac part number 15.0043).
7. Run the cutter bar for a minimum of ten seconds to evenly distribute the oil.
8. Install the cutting edge cover onto the cutter bar.

Checking and Adjusting Upper Blade Guide Clearance

1. Park the power unit and boom mower on a level surface, rotate the cutter bar parallel with the ground, and support the cutter bar with blocks beneath the inner and outer skid plates.
2. Engage the parking brake, shut off the engine, and remove the key from the ignition switch.
3. Check the clearance between the upper blade guide (A) and the guard. There should be enough clearance to insert one blade guide shim (B), but not enough to allow the insertion of two shims.

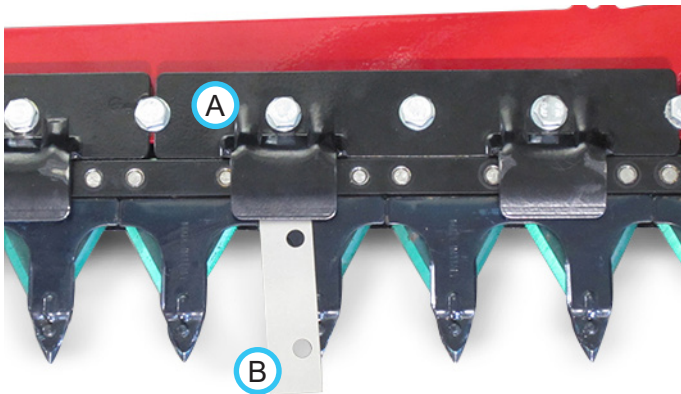

4. If the upper blade guide clearance needs to be adjusted, remove the bolts for the blade guide.
5. Add or remove one shim at a time until the correct clearance is achieved.
6. Loosely install the upper blade guide bolts down through the cutter bar and into the double inner guides on the bottom of the cutter bar.

7. Place shims between the front edge of the upper blade guide and the blade bar to properly locate the upper blade guide.



8. Torque the blade guide bolts to 40 ft-lbs (55 Nm).
9. Check the clearance between the drive plates and the upper and lower blade drive clamps (C). There should be enough clearance to insert one blade guide shim between the drive plate and the clamp on both the top and bottom.

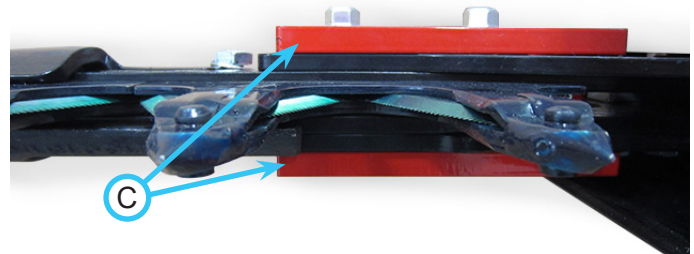

10. If the blade drive clamps need to be adjusted, remove the two clamp bolts.
11. Add or remove one shim at a time to the clamp that needs adjustment until the correct clearance is achieved.
12. Reinstall the clamp bolts up through the clamps and torque to 31 ft-lbs (42 Nm).

SERVICE

Blade Assembly Removal

⚠ CAUTION

Knife blades and guards are sharp. Always wear heavy gloves when working with blades and guards.

1. Park the power unit and boom mower on a level surface and fold in the boom mower arms.
2. Engage the parking brake, shut off the engine, and remove the key from the ignition switch.
3. Remove the cutter drive cover (A) and the skid plate (B) under the cutter drive.

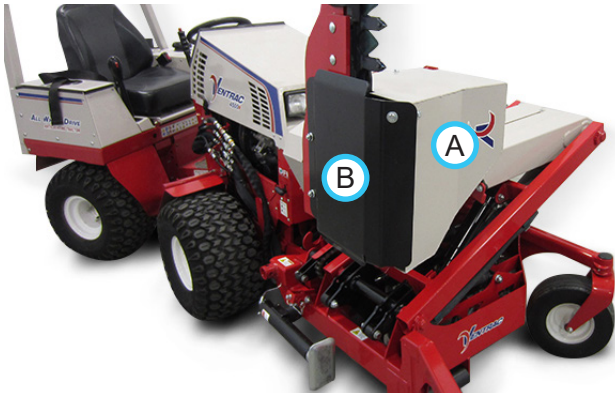

4. Rotate the cutter bar until it is parallel to the ground. Support the outer end of the cutter bar with a stand or a hoist.
5. Remove the four bolts (C) from the clamps for the blade bearing housing.

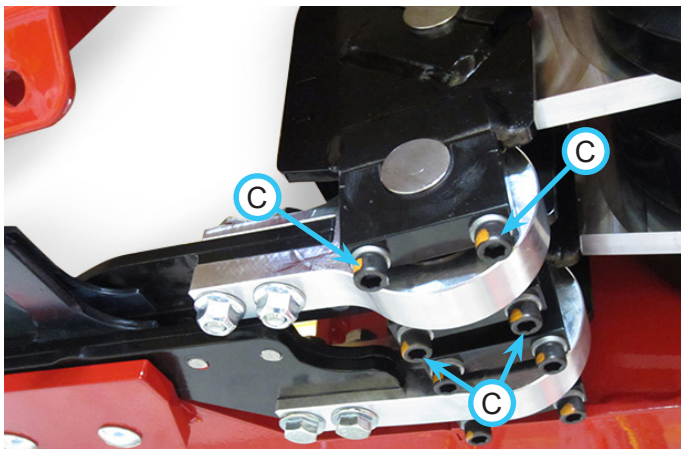

6. Rotate the crankshaft (D) to position the rod (E) near the top of the stroke to clear the blade bearing housing (F).

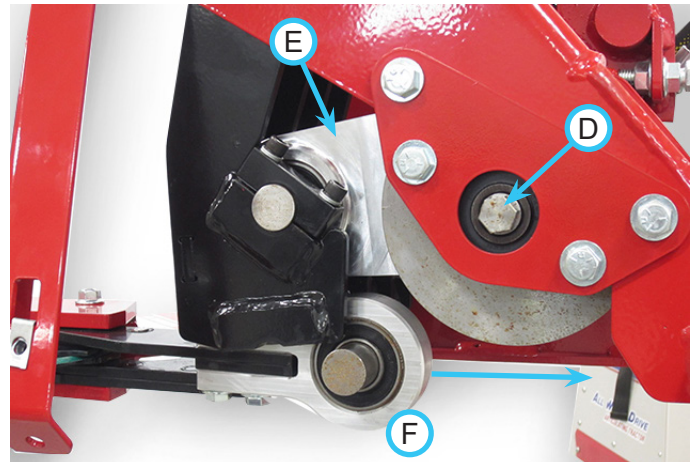

7. Pull the blade bearing housing straight back to remove the blade assembly from the cutter bar.

Blade Assembly Replacement

⚠ CAUTION

Knife blades and guards are sharp. Always wear heavy gloves when working with blades and guards.

1. If replacing the entire blade assembly (Ventrac part # 70.8189), remove the two bolts (A) that fasten the blade bearing housing to the blade assembly.

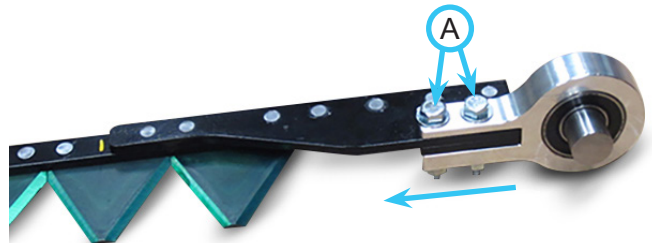

2. Install the blade bearing housing onto the new blade assembly. Slide the bearing housing up against the end of the blade bar. Make sure the bearing housing is square with the blade bar. Torque bolts to 31 ft-lbs (42 Nm).

Install the new blade assembly in the cutting arm. If the old blade assembly can be repaired, save and repair for future use.

SERVICE

Knife Blade Replacement

⚠ CAUTION

Knife blades and guards are sharp. Always wear heavy gloves when working with blades and guards.

1. After removing the blade assembly from the cutter bar, place the blade assembly on your work surface with the bottom side up.
2. Center punch the two rivets (A) on the knife blade that is being replaced.

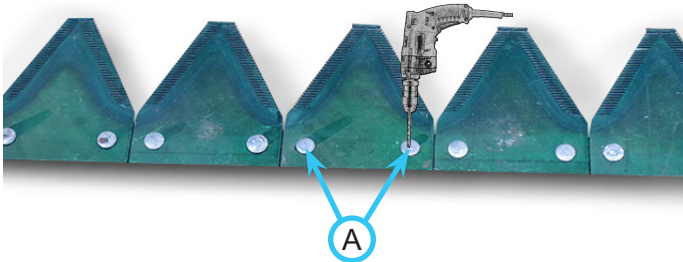

3. Use a 1/4" drill bit to drill through the rivet head.
4. Remove and discard the knife blade and rivets.
5. Place the new tooth in position and insert the new rivets up through the blade bar and knife blade. NOTE: the rivets must be installed from the blade bar side, not from the knife blade side.
6. Crimp the rivets to secure the knife blade to the blade bar.
7. Inspect the rivets to ensure the knife blade is held securely and that the rivet head is flush with the bottom of the knife blade. If necessary, grind the rivets down until flush with the knife blade.

Blade Assembly Installation

⚠ CAUTION

Knife blades and guards are sharp. Always wear heavy gloves when working with blades and guards.

1. Slide the blade assembly into the cutter bar until the bearing shaft (A) is aligned with the groove in the drive link base (B).

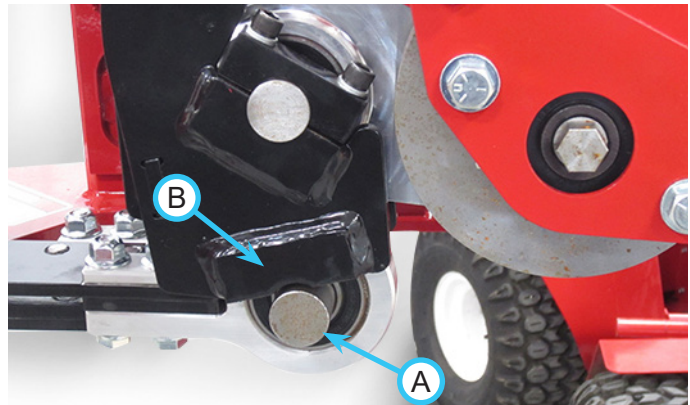

2. Position the blade assembly in the cutter bar by placing shims between the blade bar and the upper blade guides.

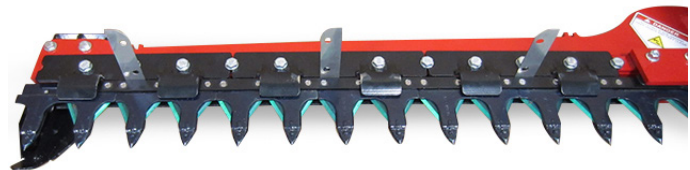

3. Position the clamps (C) on the drive link base and loosely install the bolts.

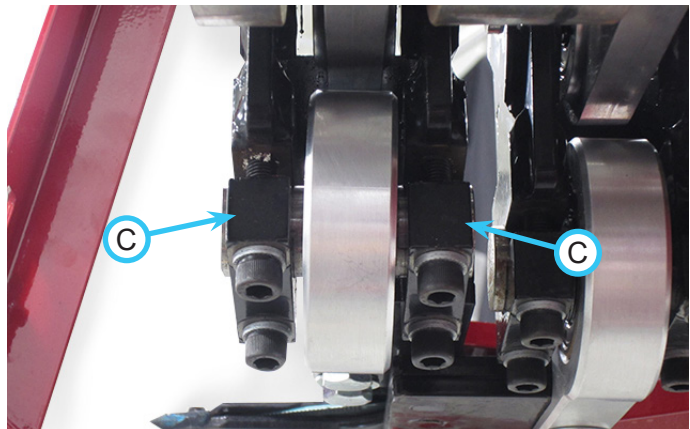

4. Tighten the clamp bolts, alternating between the two bolts in order to maintain an even gap between the clamp and base on both sides of the shaft. Torque to 25 ft-lbs (34 Nm).
5. Rotate the crankcase to ensure the blade bearing housing does not contact the blade clamps at any point in the stroke.

SERVICE

6. If the blade bearing housing makes contact with one of the clamp blocks, loosen the bolts for the blade bearing housing clamps.
7. Loosen the bolts on the drive shaft clamp (D) and move the drive link rocker in or out on the shaft until the blade bearing housing is centered between the two clamps.

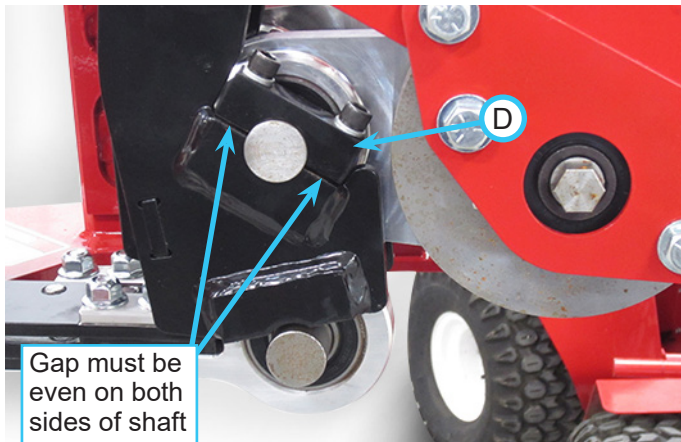

8. Tighten the two bolts on the drive shaft clamp, alternating between the two bolts in order to maintain an even gap between the clamp and base on both sides of the shaft. Torque to 25 ft-lbs (34 Nm).
9. Tighten the four bolts on the blade shaft clamps, alternating between the two bolts in order to maintain an even gap between the clamp and base on both sides of the shaft. Torque to 25 ft-lbs (34 Nm).

Double Finger Guard Replacement

⚠ CAUTION

Knife blades and guards are sharp. Always wear heavy gloves when working with blades and guards.

1. Remove the two bolts (A) that fasten the double finger guard being replaced.

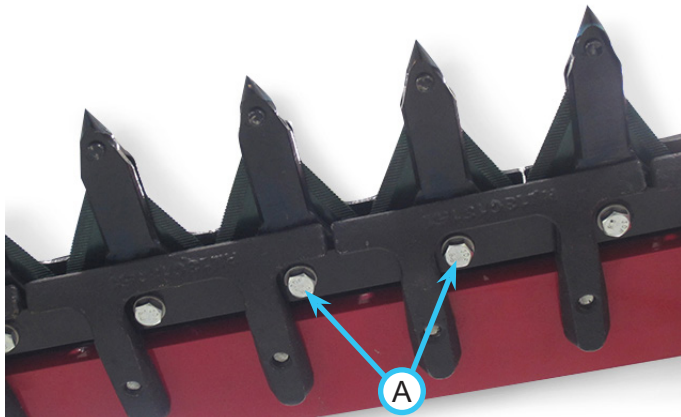

2. Slide the double finger guard out of the cutter bar.
3. Insert the new guard into the cutter bar.

4. Install the bolts through the mounting plate and into the double finger guard. NOTE: the washer is installed with the serrated edge against the bolt head.
5. Torque the bolts to 17 ft-lbs (23.5 Nm). This torque specification is critical to prevent the bolts from either working loose or stripping the threads.

Pivot Chain Tension Inspection and Adjustment

1. Park the power unit and boom mower on a level surface.
2. Fully extend the outer arm away from the boom mower and rotate the cutter bar until it is parallel with the ground.



3. Rotate the main arm until the outer arm is parallel with the ground.
4. Remove the chain guards from the main arm and then the outer arm.
5. Check the cutter head chain (A) first. If there is any slack in this chain, loosen the locking nut on the turnbuckle (B) of the outer arm chain.

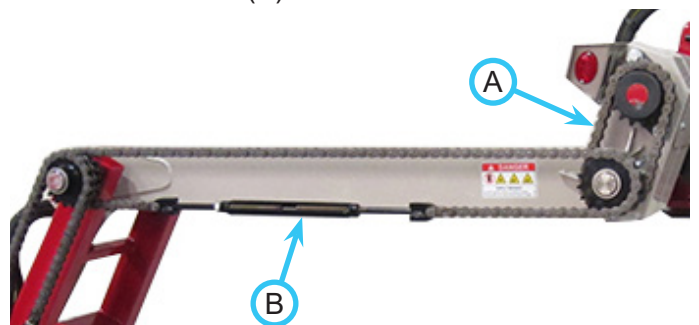

6. Tighten the turnbuckle until the slack has been removed from the cutter head chain. NOTE: the outer arm chain will need to be over-tightened in order to remove the slack from the cutter head chain.

SERVICE

7. Loosen the locking nuts on the eccentric pin stop bolt (C) and adjust the bolt until the end just touches the flange on the eccentric pin.
NOTE: the stop bolt should not place any tension on the eccentric pin.



8. Tighten the locking nuts to secure the stop bolt.
9. Loosen the outer arm turnbuckle to create some slack in the lower strand (D) of the outer arm chain.

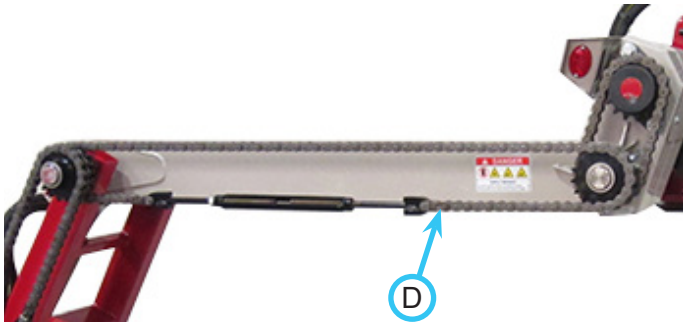

10. Adjust the outer arm turnbuckle until just tight enough to remove any slack from the lower strand of the chain, then tighten the locking nut against the end of the turnbuckle.
11. Check the lower (turnbuckle) strand on the main arm chain.
12. If there is slack in the lower strand of chain, loosen the locking nut on the turnbuckle.
13. Adjust the main arm turnbuckle until the slack is removed from the lower strand of chain, then tighten the locking nut against the end of the turnbuckle.
14. Reinstall the outer arm chain guard.
15. Reinstall the main arm chain guard.

Storage

These storage procedures are provided for seasonal storage or anytime the boom mower will remain inactive for a long period of time.

Preparing the Boom Mower for Storage

1. Clean the boom mower thoroughly.
2. Clean and lubricate the cutter bar.
3. Inspect for loose or missing hardware, damaged components, or signs of wear. Check for worn, loose, or damaged knife blades and guards. Repair or replace damaged or worn components.
4. Inspect drive belt for signs of damage or wear and replace as required.
5. Inspect hydraulic hoses and fittings for damage or wear. Connections must be tight and leak free. Replace damaged or worn components.
6. Inspect safety decals. Replace any decals that are faded, illegible, or missing.
7. Apply grease to all grease points, oil the pivot control chains, and check hydraulic oil level. Wipe off any excess grease and oil.

Removing the Boom Mower from Storage

1. Clean the boom mower to remove any accumulated dust or debris.
2. Inspect the boom mower as instructed in the daily inspection section of this manual.
3. Test the boom mower to ensure all components are working properly.

SERVICE

Maintenance Schedule

Maintenance Schedule	# of Locations	# of Pumps	AS NEEDED	Daily	At 50 Hours	At 100 Hours	At 150 Hours	At 200 Hours	At 250 Hours	At 300 Hours	At 350 Hours	At 400 Hours	At 450 Hours	At 500 Hours	At 550 Hours	At 600 Hours	At 650 Hours	At 700 Hours	At 750 Hours	At 800 Hours	At 850 Hours	At 900 Hours	At 950 Hours	At 1000 Hours	5 Years or 500 Hrs.	5 Years or 1000 Hrs.
Grease & Lubrication: See Lubrication Section																										
Cutter Head Bearing	3	1		✓	✓	✓	✓	✓	✓	✓	✓	✓	✓	✓	✓	✓	✓	✓	✓	✓	✓	✓	✓	✓		
Cutter Bar Cylinder	2	1		✓	✓	✓	✓	✓	✓	✓	✓	✓	✓	✓	✓	✓	✓	✓	✓	✓	✓	✓	✓	✓		
Cutter Bar Cylinder Pivot	1	1		✓	✓	✓	✓	✓	✓	✓	✓	✓	✓	✓	✓	✓	✓	✓	✓	✓	✓	✓	✓	✓		
Outer Arm Cylinder	1	1		✓	✓	✓	✓	✓	✓	✓	✓	✓	✓	✓	✓	✓	✓	✓	✓	✓	✓	✓	✓	✓		
Main Arm Cylinders	4	1		✓	✓	✓	✓	✓	✓	✓	✓	✓	✓	✓	✓	✓	✓	✓	✓	✓	✓	✓	✓	✓		
Caster Wheel Pivot	2	1		✓	✓	✓	✓	✓	✓	✓	✓	✓	✓	✓	✓	✓	✓	✓	✓	✓	✓	✓	✓	✓		
Wheel Axle Bearing	2	^		✓	✓	✓	✓	✓	✓	✓	✓	✓	✓	✓	✓	✓	✓	✓	✓	✓	✓	✓	✓	✓		
Cutter Bar	-	&	*	#	✓	✓	✓	✓	✓	✓	✓	✓	✓	✓	✓	✓	✓	✓	✓	✓	✓	✓	✓	✓		
Pivot Control Chains	-	\$	*		✓	✓	✓	✓	✓	✓	✓	✓	✓	✓	✓	✓	✓	✓	✓	✓	✓	✓	✓	✓		
Hydraulic System																										
Check Hydraulic Oil Level			✓																							
Change Hydraulic Filter																									✓	
Change Hydraulic Oil																										✓
Inspection																										
Inspect for Loose, Missing, or Worn Components.			✓																							
Inspect for Worn, Loose, or Broken Knife Blades & Guards			✓																							
Inspect Drive Belt, Hydraulic Hoses, & Fittings			✓																							
Inspect Blade / Guide Clearance				✓	✓	✓	✓	✓	✓	✓	✓	✓	✓	✓	✓	✓	✓	✓	✓	✓	✓	✓	✓	✓	✓	
Inspect Pivot Control Chain Tension				✓	✓	✓	✓	✓	✓	✓	✓	✓	✓	✓	✓	✓	✓	✓	✓	✓	✓	✓	✓	✓	✓	
Inspect Safety Decals			✓																							
^ Clean and lubricate after each use.																										
* Operation in severe conditions may require more frequent service intervals.																										
^ Grease until fresh grease is visible.																										
& Lubricate thoroughly with viscous (chain & cable) oil.																										
\$ Lubricate with chain oil.																										

SERVICE

Maintenance Checklist

Maintenance Checklist	# of Locations																							
	# of Pumps	At 50 Hours	At 100 Hours	At 150 Hours	At 200 Hours	At 250 Hours	At 300 Hours	At 350 Hours	At 400 Hours	At 450 Hours	At 500 Hours	At 550 Hours	At 600 Hours	At 650 Hours	At 700 Hours	At 750 Hours	At 800 Hours	At 850 Hours	At 900 Hours	At 950 Hours	At 1000 Hours	5 Years or 500 Hrs.	5 Years or 1000 Hrs.	
Grease & Lubrication: See Lubrication Section																								
Cutter Head Bearing	3	1																						
Cutter Bar Cylinder	2	1																						
Cutter Bar Cylinder Pivot	1	1																						
Outer Arm Cylinder	1	1																						
Main Arm Cylinders	4	1																						
Caster Wheel Pivot	2	1																						
Wheel Axle Bearing	2	^																						
Cutter Bar	-	&																						
Pivot Control Chains	-	\$																						
Hydraulic System																								
Check Hydraulic Oil Level																								
Change Hydraulic Filter																								
Change Hydraulic Oil																								
Inspection																								
Inspect for Loose, Missing, or Worn Components.																								
Inspect for Worn, Loose, or Broken Knife Blades & Guards																								
Inspect Drive Belt, Hydraulic Hoses, & Fittings																								
Inspect Blade / Guide Clearance																								
Inspect Pivot Control Chain Tension																								
Inspect Safety Decals																								
^ Clean and lubricate after each use.																								
* Operation in severe conditions may require more frequent service intervals.																								
^ Grease until fresh grease is visible.																								
& Lubricate thoroughly with viscous (chain & cable) oil.																								
\$ Lubricate with chain oil.																								

SPECIFICATIONS

Dimensions

Overall Height	87-1/2 inches (222.3 cm)
Overall Length	58 inches (147.3 cm)
Overall Width	63 inches (160 cm)
Weight	880 pounds (399.2 kg)
Cutting Width	39 inches (99.1 cm)
Material Cut Diameter	1/2 inch (13 mm)
Vertical Reach (From Ground).	142 inches (361 cm)
Horizontal Reach (Outside of Single Wheel)	115 inches (292 cm)
Horizontal Reach (Outside of Dual Wheels).	103 inches (262 cm)
Max Flat Top Cut (From Ground)	82 inches (208 cm)

Features

Out front design increases visibility

Maintains head angle when extending or retracting boom arms

39" (99.1 cm) double action sickle bar

Head angle ranging from 45° below horizontal to 90° vertical (135° total range)

Ability to operate on 10° slopes when used with power unit equipped with single wheels or 18° slopes when used with power unit equipped with dual wheels.

WARRANTY



LIMITED WARRANTY - VENTRAC COMMERCIAL EQUIPMENT

Venture Products, Inc., (henceforth referred to as V.P.I.) warrants on the terms and conditions herein, that it will repair, replace, or adjust any part manufactured by Venture Products Inc., and found by Venture Products, Inc., to be defective in material and/or workmanship during the applicable warranty term.

All Ventrac commercial equipment purchased and registered on or after January 1, 2019 will carry a 2-year commercial warranty. The warranty period begins on the date of original customer purchase:

Ventrac Commercial Equipment	Warranty Term
2100 SSV & Attachments	2-year
3000 Series Tractors & Attachments	2-year
4000 Series Tractors & Attachments	2-year

All Ventrac add-on kits and accessories such as: 3-point hitch, 12V front & rear power outlets, foot pedal, dual wheel kit, etc., will be covered under the above warranty periods provided they are installed by an Authorized Ventrac Dealer. This warranty may be transferred and will carry the remainder of the warranty starting from the original purchase/registration date with the dealership and/or V.P.I.

The engine warranty is covered by its respective engine manufacturer. Please refer to the engine manufacturer's warranty statement that is included in the owner's manual.

For warranty consideration on Ventrac commercial equipment, including any defective part, must be returned to an Authorized Ventrac Dealer within the warranty period. The warranty shall extend to the cost to repair or replace (as determined by V.P.I.) the defective part. The expense of pickup and delivery of equipment, service call drive time or any transportation expense incurred for warranty repair is the sole responsibility of the owner and is not covered under warranty by Ventrac and/or V.P.I. Ventrac and V.P.I.'s responsibility in respect to claims is limited to making the required repairs or replacements, and no claim of breach of warranty shall be cause for cancellation or rescission of the contract of sale of any Ventrac equipment. Proof of purchase may be required by the dealer to substantiate any warranty claim. Only warranty work performed and submitted by an Authorized Ventrac Dealer may be eligible for warranty credit.

This warranty extends only to Ventrac commercial equipment operated under normal conditions and properly serviced and maintained. The warranty expressly does NOT cover: (a) any defects, damage or deterioration due to normal use, wear and tear, or exposure; (b) normal maintenance services, such as cleaning, lubrication, oil change; (c) replacement of service items, such as oil, lubricants, spark plugs, belts, rubber hoses, bearings or other items subject to normal service replacement; (d) damage or defects arising out of, or relating to abuse, misuse, neglect, alteration, negligence or accident; (e) repair or replacement arising from operation of, or use of the equipment which is not in accordance with operating instructions as specified in the operator's manual or other operational instructions provided by V.P.I.; (f) repair or replacement arising as a result of any operation from Ventrac equipment that has been altered or modified so as to, in the determination of V.P.I., adversely affect the operation, performance or durability of the equipment or that has altered, modified or affected the equipment so as to change the intended use of the product; (g) repair or replacement necessitated by the use of parts, accessories or supplies, including gasoline, oil or lubricants, incompatible with the equipment or other than as recommended in the operator's manual or other operational instructions provided by V.P.I.; (h) repairs or replacements resulting from parts or accessories which have adversely affected the operation, performance or durability of the equipment; or (i) damage or defects due to or arising out of repair of Ventrac equipment by person or persons other than an authorized Ventrac service dealer or the installation of parts other than genuine Ventrac parts or Ventrac recommended parts.

WARRANTY



LIMITED WARRANTY - VENTRAC COMMERCIAL EQUIPMENT

The sole liability of V.P.I. with respect to this warranty shall be the repair and replacement as set forth herein. V.P.I. shall have no liability for any other cost, loss, or damage. In particular V.P.I. shall have no liability or responsibility for: (i) expenses relating to gasoline, oil, lubricants; (ii) loss, cost or expense relating to transportation or delivery of turf equipment from the location of owner or location where used by owner to or from any Authorized Ventrac Dealer; (iii) travel time, overtime, after hours' time or other extraordinary repair charges or charge relating to repairs or replacements outside of normal business hours at the place of business of an Authorized Ventrac Dealer; (iv) rental of like or similar replacement equipment during the period of any warranty repair or replacement work; (v) any telephone or telegram charges; (vi) loss or damage to person or property other than that covered by the terms of this warranty; (vii) any claims for lost revenue, lost profit or additional cost or expense incurred as a result of a claim of breach of warranty; or (viii) attorney's fees.

The remedies of buyer set forth herein are exclusive and are in lieu of all other remedies. The liability of V.P.I., whether in contract, tort, under any warranty, or otherwise, shall not extend beyond its obligation as set forth herein. V.P.I. shall not be liable for cost of removal or installation nor shall V.P.I. be responsible for any direct, indirect, special or consequential damages of any nature. In no event shall V.P.I. be liable for any sum in excess of the price received for the goods for which liability is claimed.

There are no representations or warranties which have been authorized to the buyer of the Ventrac commercial equipment other than set forth in this warranty. Any and all statements or representations made by any seller of this equipment, including those set forth in any sales literature or made orally by any sales representative, are superseded by the terms of this warranty. Any affirmation of fact or promise made by V.P.I. or any of its representatives to the buyer which relates to the goods that are the subject to this warranty shall not be regarded as part of the basis of the bargain and shall not be deemed to create any express warranty that such goods shall conform to the affirmation or promise.

No employee, distributor, or representative is authorized to change the foregoing warranties in any way or grant any other warranty on behalf of V.P.I.

Some states do not allow limitations on how long an implied warranty lasts or allow the exclusion on limitation of incidental or consequential damages, so the above limitation or exclusion may not apply to you.

This warranty gives you specific legal rights, and you may also have other rights which vary from state to state.

This warranty applies to all Ventrac commercial equipment sold by Venture Products Inc.